



ZARYAB
INSTRUMENTS

Products that saves life



Dental Instruments

01

**EXTRACTING FORCEPS**

Page # 01 - 14

02

**ROOT ELEVATORS**

Page # 15 - 29

03

**DIAGNOSTIC, PROBES, SCALERS, FILLING
& LABORATORY INSTRUMENTS**

Page # 30 - 77

04

**MAXILLOFACIAL SURGERY
INSTRUMENTS**

Page # 78 - 95

05

**ORTHODONTIC INSTRUMENTS
& PLIERS**

Page # 96 - 107

06

**DENTAL IMPLANT INSTRUMENTS**

Page # 108 - 142

07

Impression Tray & Hollow wares

Page # 143 - 148



CENTIMETERS

EXTRACTING FORCEPS

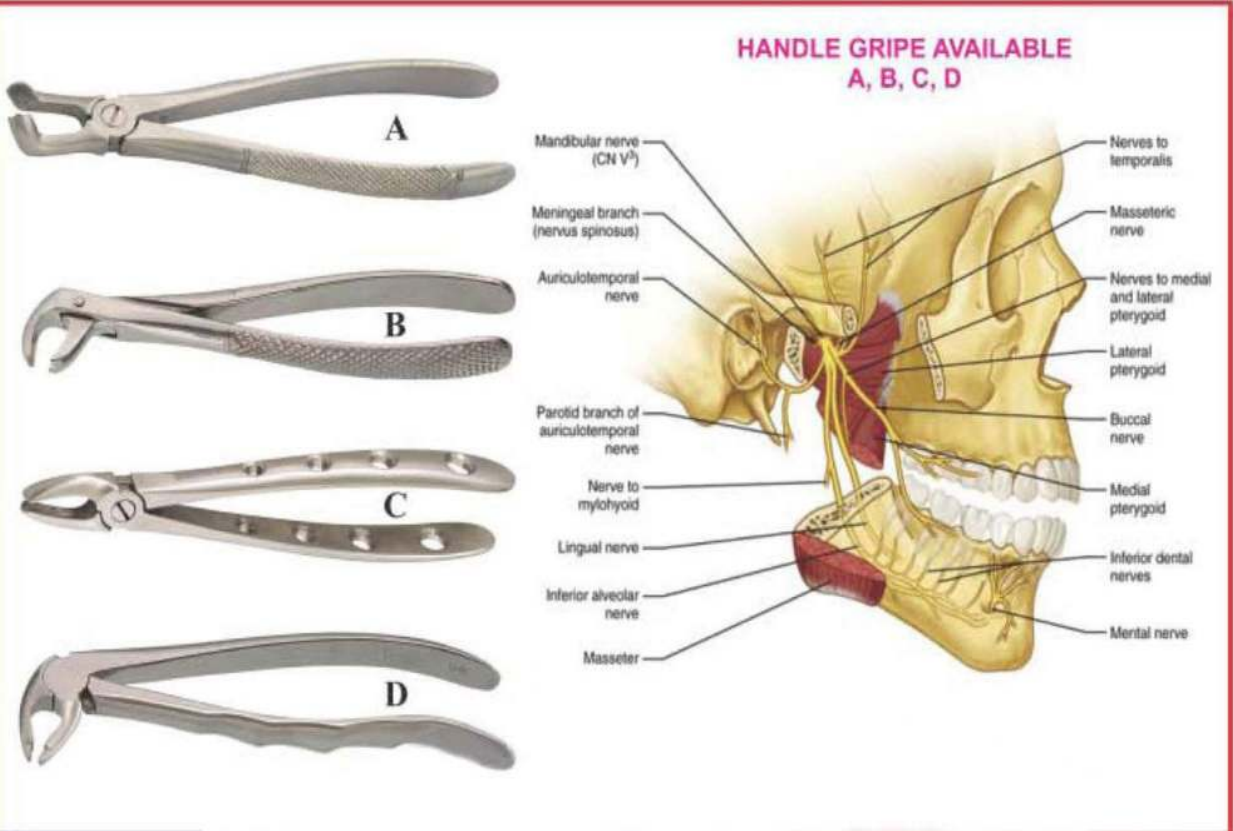

INCHES

EXTRACTING FORCEPS (English Pattern)

- Щипцы экстракционные (английская форма)
- Daviers (Forme Anglaise)
- Zahnzangen (Englische Form)

- Щипці екстракційні (англійська форма)
- Forceps de Extracción (Forme Inglesa)
- استخراج المنطق (نمط اللغة الإنجليزية)



ZI-001
Fig. 23
Syndesmotome lower roots



ZI-002
Fig. 24
Syndesmotome upper molar



BSI-003
Fig. 25
Syndesmotome Lower molar forceps



ZI-004
Fig. 79
Lower Wisdoms



ZI-005
Fig. 60
Upper roots, extra slim jaws



ZI-006
Fig. 62
Upper roots, extra slim jaws



ZI-007
Fig. 74
Upper roots and incisors



ZI-008
Fig. 33
Lower Roots



ZI-009
Fig. 51
Upper Roots



ZI-010
Fig. 61
upper Roots, short,
extra slim jaws



ZI-011
Fig. 67
upper wisdoms,
either sides



ZI-012
Fig. 86
lower molars decayed or
with broken down crown

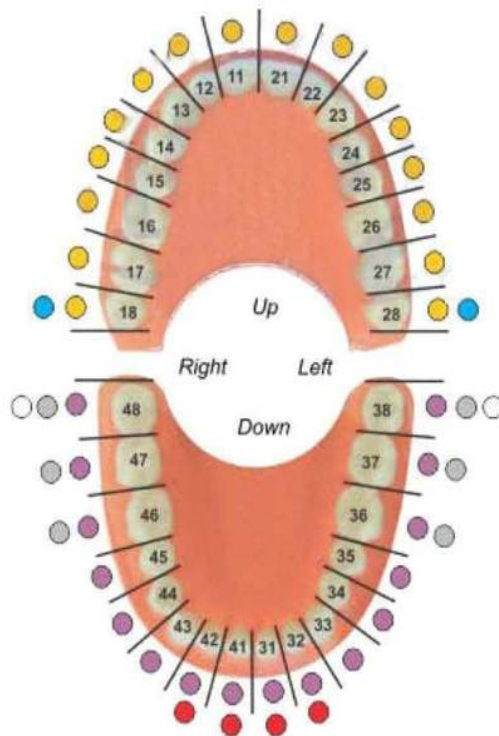

EXTRACTING FORCEPS (English Pattern)

- Щипцы экстракционные (английская форма)
- Daviers (Forme Anglaise)
- Zahnzangen (Englische Form)

- Щипці екстракційні (англійська форма)
- Forceps de Extracción (Forme Inglesa)
- استخراج الملقط (مط اللغة الإنجليزية)



ZI-013
Fig. 01
upper centrals and canines



ZI-014
Fig. 04
Lower incisors and Canines



ZI-015
Fig. 08
Lower Bicuspids



ZI-016
Fig. 17
Upper right molars



ZI-017
Fig. 73
Lower molars



ZI-018
Fig. 21
Lower molars



ZI-019
Fig. 02
upper incisors and canines



ZI-020
Fig. 07
Lower Canines and bicuspids



Lower Canines and bicuspid teeth



ZI-022
Fig. 18
Upper Left Molars



ZI-023
Fig. 22
Lower molars - Untere Molaren



ZI-024
Fig. 75
Lower canines and bicuspids

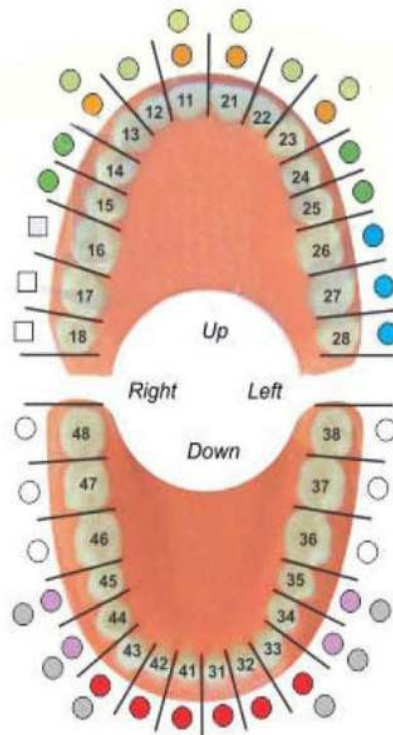

EXTRACTING FORCEPS (English Pattern)

- Щипцы экстракционные (английская форма)
- Daviers (Forme Anglaise)
- Zahnzangen (Englische Form)

- Щипці екстракційні (англійська форма)
- Forceps de Extracción (Forme Inglesa)
- استخراج الملقط (نمط اللغة الإنجليزية)

Apical Set of 9 Pcs (Deep Gripe Extracting Forceps)

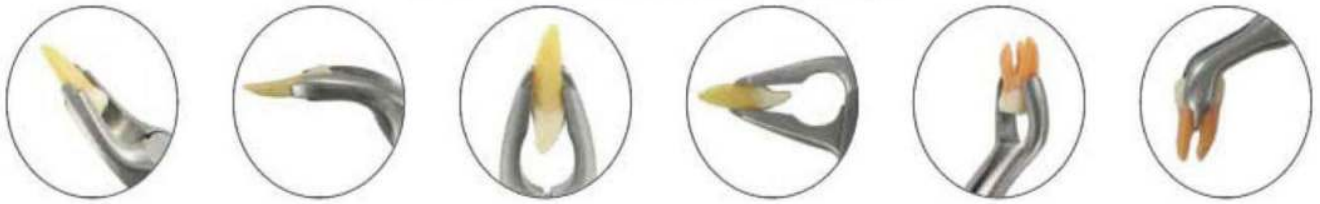

- No Fracture
- No Tissue Damage
- Extraction With Easy

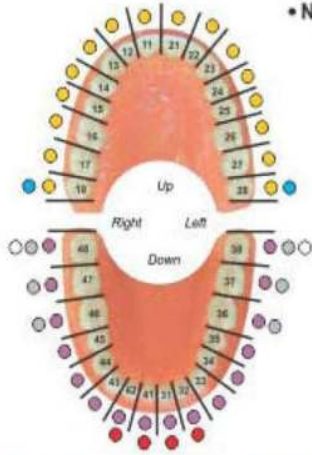

A-TRAUMATIC EXTRACTION SET

Improved tapered beaks for complete root contact. Cross serrations for a never slip grasp. Easily enter the sub gingival.

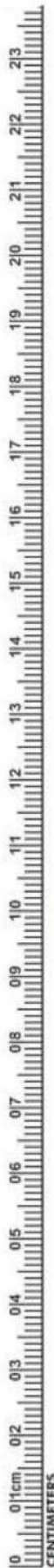

EXTRACTING FORCEPS (English Pattern)

- Щипцы экстракционные (английская форма)
- Щипці екстракційні (англійська форма)
- Daviers (Forme Anglaise)
- Forceps de Extracción (Forme Inglesa)
- Zahnzangen (Englische Form)
- استخراج الملقط (نمط اللغة الإنجليزية)



Fig. 79A



Fig. 45Z



Fig. 51Z



Fig. 44Z



Fig. 46



Fig. 67



Fig. 67A



Fig. 79



Z1-034
Fig. 9
Apex Forceps Lower Universal
Deep Root Pick



Z1-035
Fig. 187
Apex Forceps Lower Root
Deep Root Pick



Z1-036
Fig. 189
Apex Forceps
Upper Root
Deep Root Pick



Z1-037
Fig. 190
Apex Forceps Upper Root
Deep Root Pick



Z1-038
Fig. 46XL
Apex Forceps Lower Root
Deep Root Pick

DEEP ROOT PICK FORCEPS (Apical Set of 9)

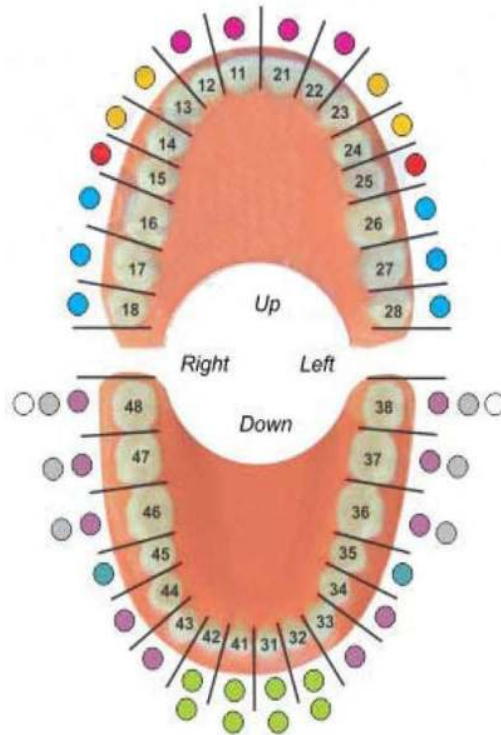

Z1-039
Fig. 67
Upper Thrid Molars

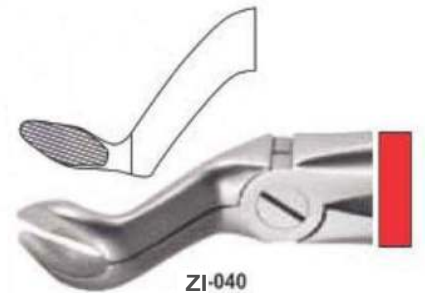

Z1-040
Fig. 67A
Upper Thrid Molars

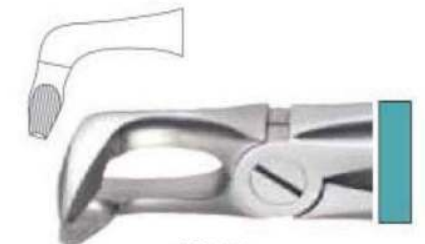

Z1-041
Fig. 79
Lower Thrid Molars



Z1-042
Fig. 37
Lower Root Molars



EXTRACTING FORCEPS (English Pattern)

- Щипцы экстракционные (английская форма)
- Daviers (Forme Anglaise)
- Zahnzangen (Englische Form)

- Щипці екстракційні (англійська форма)
- Forceps de Extracción (Forme Inglesa)
- استخراج الملظ (نمط اللغة الإنجليزية)



ZI-043
Fig. 2
upper laterals and canines



ZI-044
Fig. 7
Upper Premolars/Bicuspids



ZI-045
Fig. 17
Upper Molars, Right



ZI-046
Fig. 18
Upper Molars, Left



ZI-047
Fig. 67
upper third molars



ZI-048
Fig. 13
Lower Premolars/
Bicuspids



ZI-049
Fig. 22
Lower Molars



ZI-050
Fig. 33
lower roots



ZI-051
Fig. 51
upper roots



ZI-052
Fig. 79
Lower third molars

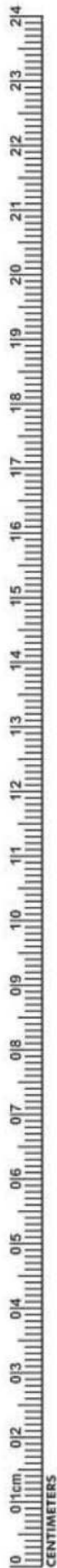
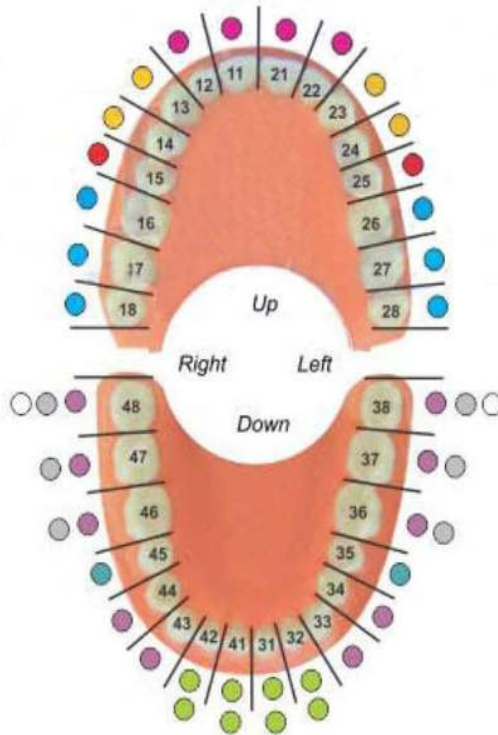

EXTRACTING FORCEPS (English Pattern)

- Щипцы экстракционные (английская форма)
- Daviers (Forme Anglaise)
- Zahnzangen (Englische Form)
- Щипці екстракційні (англійська форма)
- Forceps de Extracción (Forme Inglesa)
- استخراج الملقط (تمط اللغة الإنجليزية)



ZI-053
Fig. 1
upper laterals
and canines



Extracting Forceps
Set of 10 Pcs
Detail of Pack
Forceps
Fig. 1
Fig. 2
Fig. 73
Fig. 67
Fig. 51A
Fig. 74
Fig. 51
Fig. 17
Fig. 7
Fig. 13



ZI-058
74
lower roots



ZI-054
2
upper laterals
and canines



ZI-059
51
upper roots



ZI-055
73
lower molars

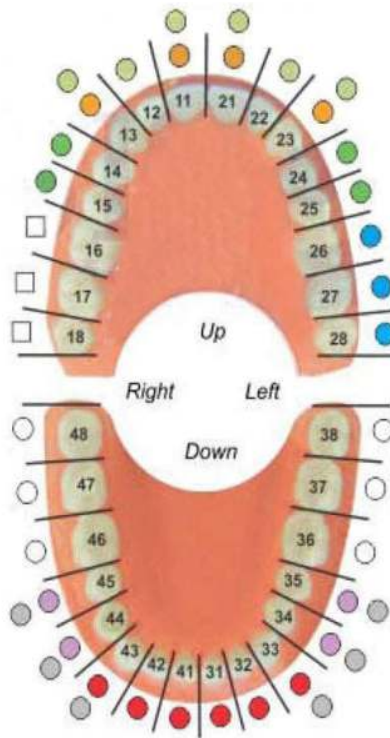

ZI-056
67
upper third
molars

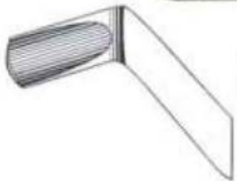

ZI-060
17
upper molars,
right



ZI-061
7
upper premolars



ZI-057
51 A
upper roots

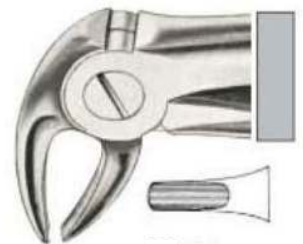

ZI-062
13
lower premolars



EXTRACTING FORCEPS (English Pattern)

- Щипцы экстракционные (английская форма)
- Daviers (Forme Anglaise)
- Zahnzangen (Englische Form)

- Щипці екстракційні (англійська форма)
- Forceps de Extracción (Forme Inglesa)
- استخراج الملقط (نمط اللغة الإنجليزية)



Fig. 1 Fig. 7 Fig. 13 Fig. 17 Fig. 18 Fig. 22 Fig. 33A Fig. 51A Fig. 67A Fig. 79

Set of 10 Pieces
 Fig. 1
 Fig. 7
 Fig. 13
 Fig. 17
 Fig. 18
 Fig. 22
 Fig. 33A
 Fig. 51A
 Fig. 67A
 Fig. 79



ZI-063
 Fig. 1
 Upper Centrals
 & Canines/Cuspids



ZI-064
 Fig. 7
 Upper Premolars/
 Bicuspids



ZI-065
 Fig. 13
 Lower Premolars/
 Bicuspids



ZI-066
 Fig. 17
 Upper Molars,
 Right



ZI-067
 Fig. 18
 Upper Molars,
 Left



ZI-068
 Fig. 22
 Lower Molars



ZI-069
 Fig. 33A
 Lower Roots
 Narrow tips



ZI-070
 Fig. 51A
 Upper roots
 narrow tips



ZI-071
 Fig. 67A
 Upper third
 molars



ZI-072
 Fig. 79
 Lower third
 molars

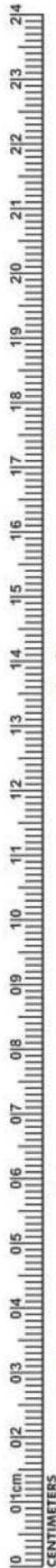
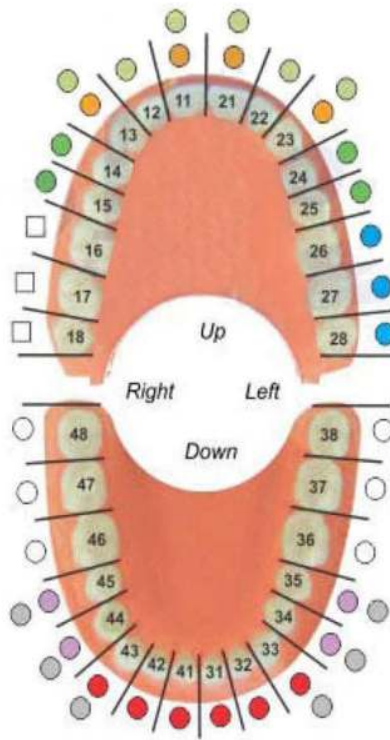

EXTRACTING FORCEPS

- Щипцы экстракционные
- Daviers
- Zahnzangen
- Щипці екстракційні
- Forceps de Extracción
- استخراج الملقط

Pediatric Tooth Extracting Forceps Set



ZI-074
English Pattern Klein #51S
Pedodontic Upper root



ZI-073
English Pattern Klein #137
Pedodontic, Upper Incisors
Spring handle



ZI-077
English Pattern Klein #5
Pedodontic Lower Incisors.



ZI-075
English Pattern Klein #139
Pedodontic Upper Premolars



Fig. # 01 to 07
Set of 7 Pieces



ZI-078
English Pattern Klein #7
Pedodontic Lower Roots,



ZI-076
English Pattern Klein #3
Pedodontic Upper Molars
Universal

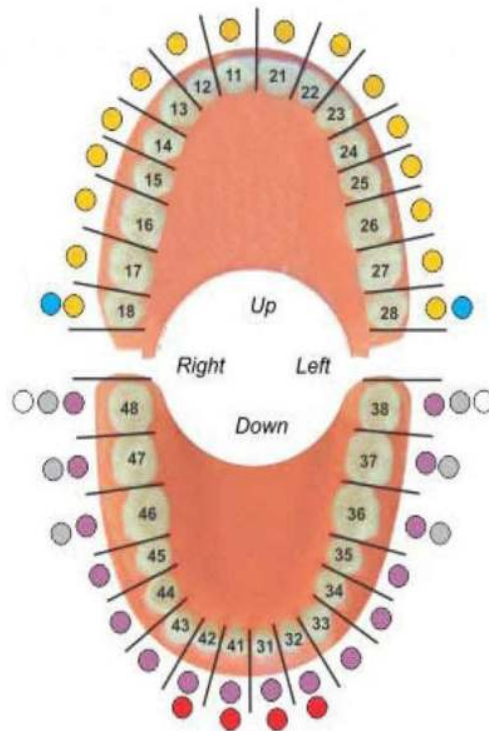

ZI-079
English Pattern Klein #6
Pedodontic Lower Molars,
Spring Handle



EXTRACTING FORCEPS

- Щипцы экстракционные
- Daviers
- Zahnzangen
- Щипці екстракційні
- Forceps de Extracción
- استخراچ المنقط



ZI

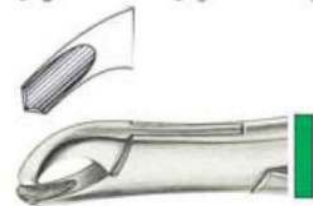

ZI-080
Fig. 17 SK
Lower molars



ZI-081
Fig. 150 SK
Upper anteriors and roots

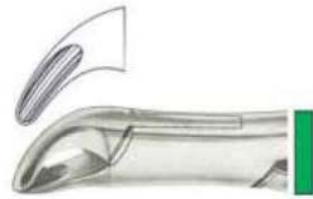

ZI-082
Fig. 151 SK
lower anteriors and roots



ZI-083
Fig. 90
Upper molars, left



ZI-084
Fig. 17S
Lower, molars



ZI-085
Fig. 18LS
upper, molars left



ZI-086
Fig. 18RS
upper, molars right



ZI-087
Fig. 65S
upper incisors and roots



ZI-088
Fig. 69S
upper and lower roots

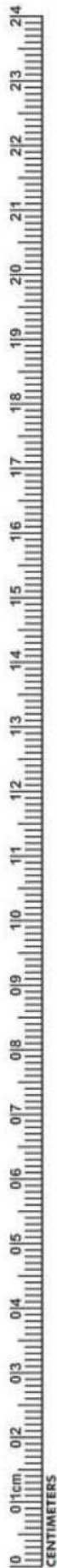
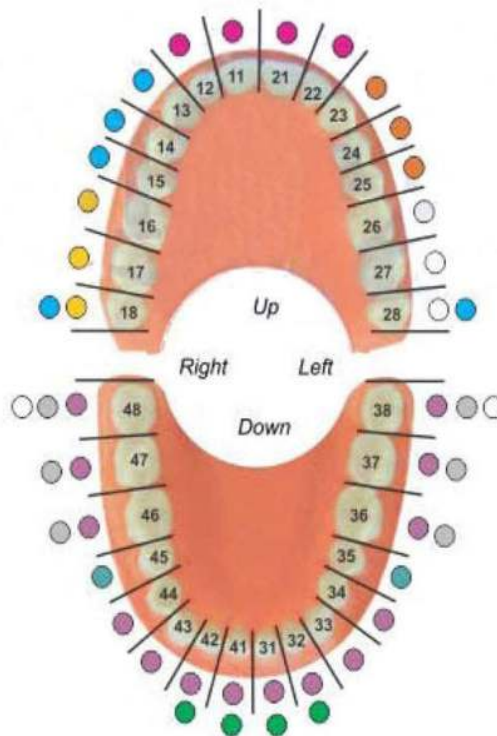

EXTRACTING FORCEPS (American Pattern)

- Щипцы экстракционные (американская форма)
- Daviers - forme américaine
- Férceps de extracción - forma americana
- Щипці скрапційні (американська форма)
- Pinzaper per estrazione - forma americana
- استخراج الملقط (الأمريكي)



**ZI-089
150
Cryer upper incisors, premolars, roots**



**ZI-090
150A
Cryer upper incisors, premolars, roots**



**ZI-091
150S
Cryer upper teeth, for children**

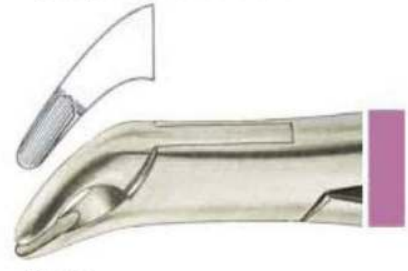

**ZI-092
151A
Cryer lower incisors, premolars, roots**



**ZI-093
151 S
Cryer lower incisors, premolars, roots**

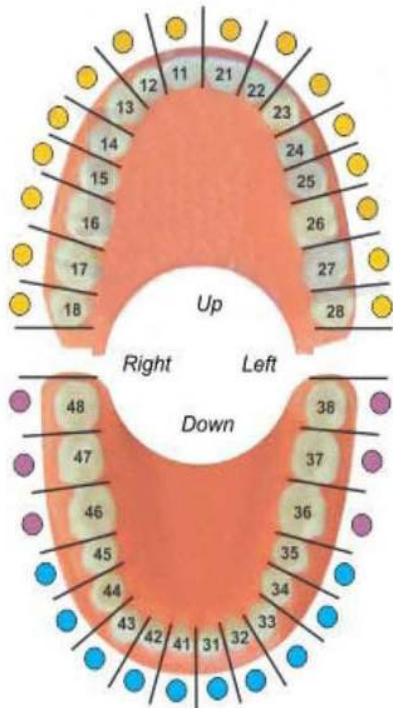

**ZI-094
151
Cryer lower teeth, for children**



**ZI-095
286
upper incisors and roots**



**ZI-096
Cohen universal forceps**

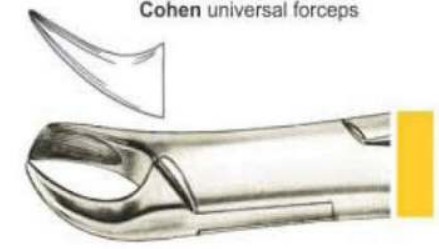

**ZI-097
89
Upper molars, right**

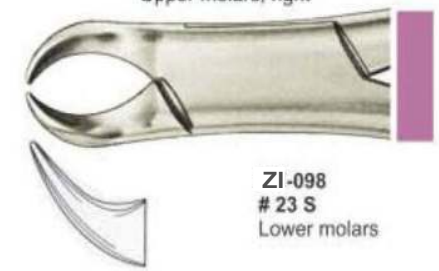

**ZI-098
23 S
Lower molars**



EXTRACTING FORCEPS (American Pattern)

- Щипцы экстракционные (американская форма)
- Daviers - forme américaine
- Férceps de extracción - forma americana
- Щипці скстракційні (американська форма)
- Pinzeper per estrazione - forma americana
- استخراج الملقط (النمط الأمريكي)

Fig. 2

Fig. 4

Fig. 7

Fig. 13

Fig. 17

Fig. 18 L

Fig. 18 R

Fig. 29 S

Fig. 35

Cohen



ZI-099
2
upper and lower roots



ZI-104
18 L
Harris upper molars, left

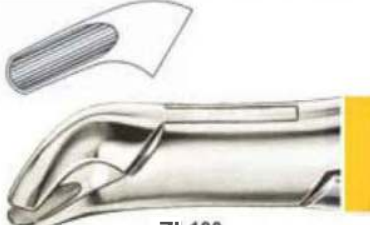

ZI-100
4
upper and lower premolars

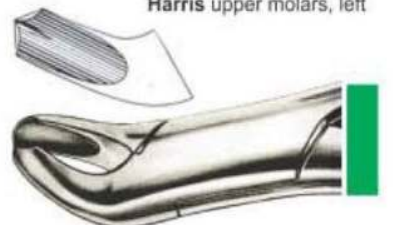

ZI-105
18R
Harris upper molars, right

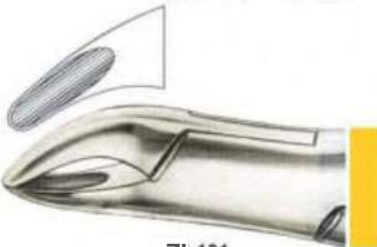

ZI-101
7
upper roots

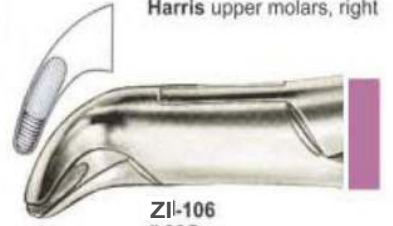
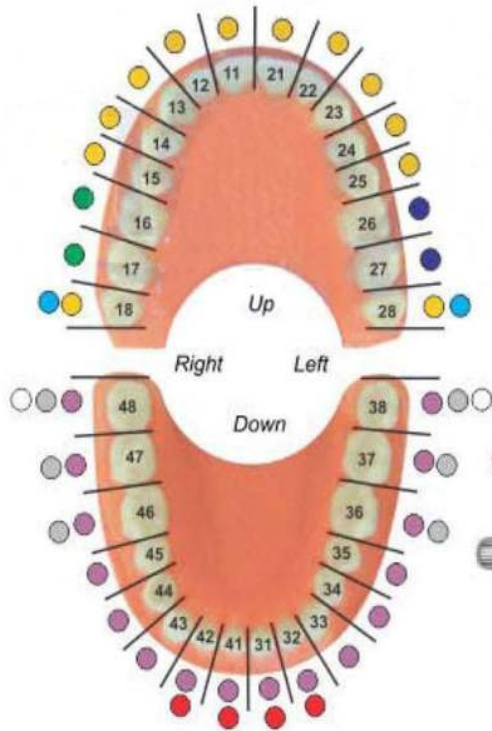

ZI-106
29S
lower teeth, for children

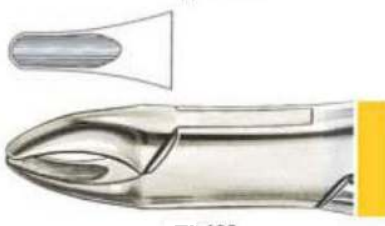

ZI-102
13
upper incisors



ZI-107
35
upper roots



ZI-103
17
lower molars

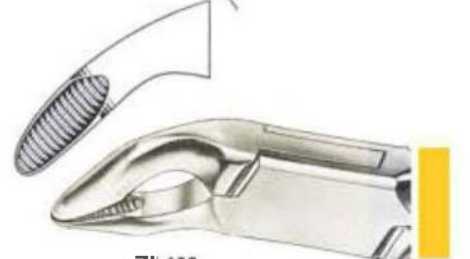

ZI-108
Cohen
universal forceps

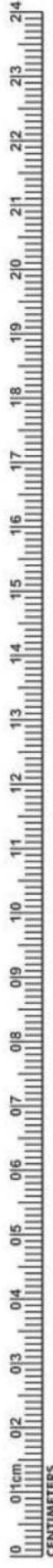

CENTIMETERS

EXTRACTING FORCEPS (American Pattern)

- Щипцы экстракционные (американская форма)
- Daviers - forme américaine
- Férceps de extracción - forma americana
- Щипці скстракційні (американська форма)
- Pinzere per estrazione - forma americana
- استخراج المنطق (المنطق الأمريكي)



ZI-109
Fig. 1
Upper Anterior

ZI-110
Lower Molar
Fig. 23 Cow Horn



ZI-111
Fig. 74
Lower Anterior



ZI-112
Fig. 88L
Upper Molar Left



ZI-113
Fig. 88R
Upper Molar Right



ZI-114
Fig. 74
Lower Anterior



ZI-115
Fig. 106
Lower Incisors



ZI-116
Fig. 174
Extra Narrow
Lower Anterior
Apical Retention
Forceps



ZI-117
Fig. 859
Lower Molars
Roots



DENTAL SYRINGES

- Шприцы стоматологические карпульные
- Seringues à usage dentaire
- Dentspritzen

- Шприці стоматологічні карпульні
- Jeringas dentales
- المحاقن الأسنان



ZI-118 1.8ML
ZI-119 2.2ML



ZI-120 1.8ML
ZI-121 2.2ML



ZI-122 1.8ML
ZI-123 2.2ML



ZI-124 1.8ML
ZI-125 2.2ML



ZI-126 1.8ML
ZI-127 2.2ML



ZI-128 1.8ML
ZI-129 2.2ML



ZI-130
1001
Intraligamental
Anesthesia Syringe
in Black Colour



ZI-131 1.8ML
ZI-132 2.2ML
Angled



ZI-133
Aluminium



ZI-134
Aluminium - Silver 1.8 ml



ZI-135
Aluminium - Orange 1.8 ml



ZI-136
Aluminium - Green 1.8 ml



ZI-137
Aluminium - Blue 1.8 ml

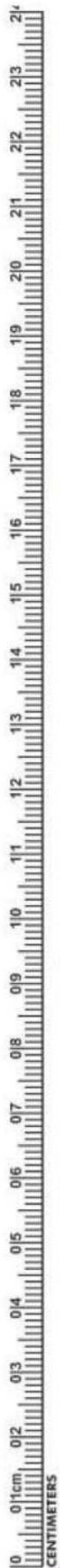

BONE ROUNGER

- Костные кусачки
- Kuhlmeißelzangen
- Pincés-gouges
- Кусачки для кісток
- Pinzas-gubias
- روتچورس العظام



ZI-138
Blumenthal
15cm



ZI-139
Blumenthal
15cm



ZI-140
Blumenthal
15cm



ZI-141
Friedman
14cm



ZI-142
Friedman
14.5cm



ZI-143
Micro-Friedman
14cm



ZI-144
Micro-Friedman
15cm



ZI-145
Micro-Friedman
16cm



ZI-146
Kleinert-Kutz
18.5cm



ZI-147
Beyer
18.5cm



ZI-148
Mead 1A
18.5cm



ZI-149
Luer
18.5cm



INCHES

ROOT ELEVATORS

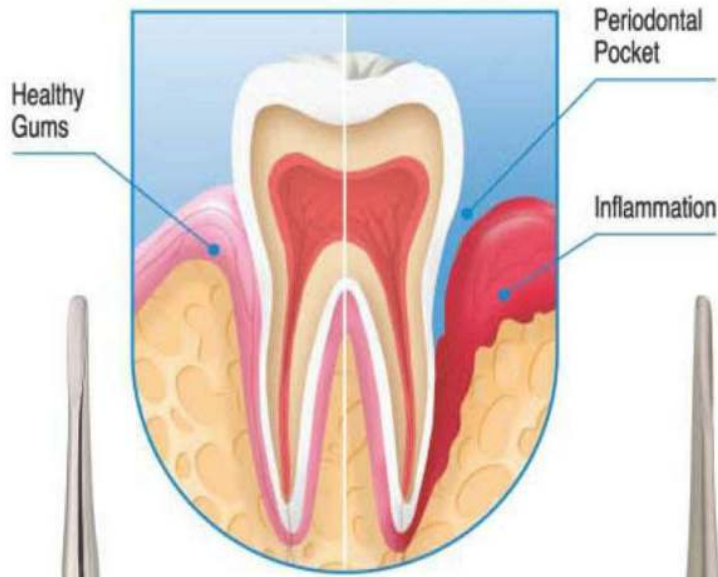

**HANDLES FOR ROOT ELEVATORS POINTS
A, B, C, D**

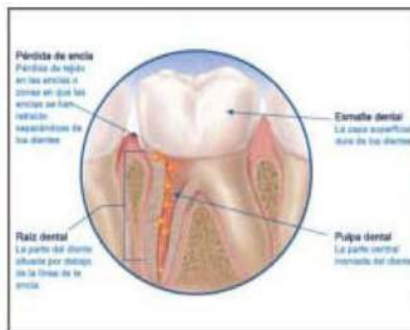

10 01cm, 012, 013, 014, 015, 016, 017, 018, 019, 020, 021, 022, 023, 024
CENTIMETERS

ROOT ELEVATOR

- Элеватор корневой экстракционный
- Elévateurs à racines
- Wurzelheber
- Elevator corneviu extracționii
- Elevadores para raíces
- المصاعد الجذر

Apexo Root Elevators



Apexo



ZI-150
Apexo
2.5x9mm
Straight



ZI-151
Apexo
2.7x9mm
Straight



ZI-152
Apexo
3.0x9mm
Straight



ZI-153
Apexo
2.5x9mm
Curved



ZI-154
Apexo
3.0x9mm
Curved



ZI-155
Seldin
3.0x14mm
Straight

Luxator Root Elevators



Luxator



ZI-156
Luxator
3mm
straight



ZI-157
Luxator
3mm
curved



ZI-158
Luxator
4mm
straight



ZI-159
Luxator
4mm
curved



ZI-160
Luxator
5mm
straight



ZI-161
Luxator
5mm
curved

Bein Root Elevators



Bein



ZI-162
Bein 2mm



ZI-163
Bein 3mm



ZI-164
Bein 4mm

Seldin Root Elevators



Seldin



ZI-165
Fiohr 1



ZI-166
Seldin 34S



ZI-167
Seldin 34



ROOT ELEVATOR

- Элеватор корневой экстракционный
- Elévateurs à racines
- Wurzelheber
- Elevador cornevio extraiccionii
- Elevadores para raices
- المصاعد الجذر

Apexo Root Elevators



Apexo



ZI-168
Apexo
2.5x9mm
Straight



ZI-169
Apexo
2.7x9mm
Straight



ZI-170
Apexo
3.0x9mm
Straight



ZI-171
Apexo
2.5x9mm
Curved



ZI-172
Apexo
3.0x9mm
Curved



ZI-173
Seldin
3.0x14mm
Straight

Luxator Root Elevators



Luxator



ZI-174
Luxator
3mm
straight



ZI-175
Luxator
3mm
curved



ZI-176
Luxator
4mm
straight



ZI-177
Luxator
4mm
curved



ZI-178
Luxator
5mm
straight



ZI-179
Luxator
5mm
curved

Bein Root Elevators



Bein



ZI-180
Bein 2mm



ZI-181
Bein 3mm



ZI-182
Bein 4mm

Seldin Root Elevators



Seldin



ZI-183
Flohr 1



ZI-184
Seldin 34S



ZI-185
Seldin 34

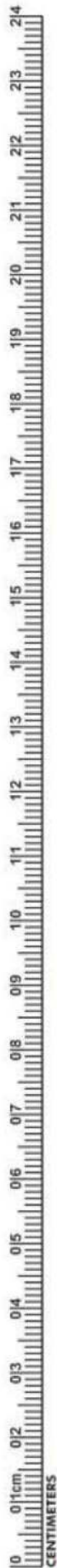

ROOT ELEVATOR

- Элеватор корневой экстракционный
- Elévateurs à racines
- Wurzelheber
- Элеватор корневий екстракційний
- Elevadores para raices
- المصاعد الجذر

Apical Root Elevators

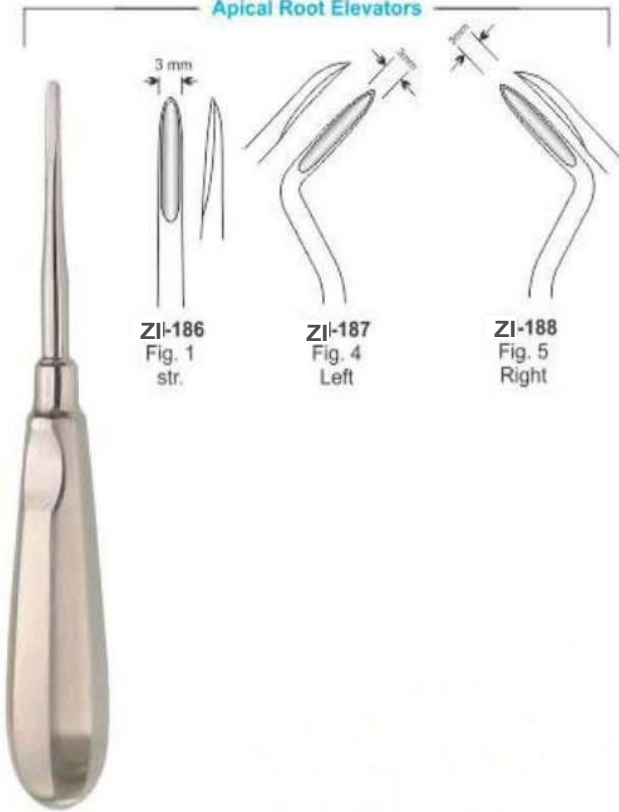

Apical Root Elevators

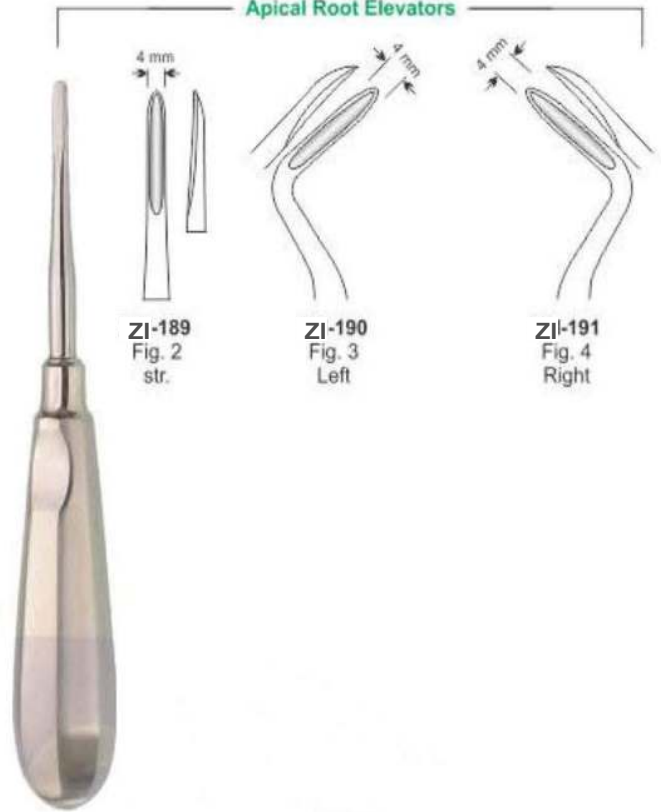

Coupland Root Elevators

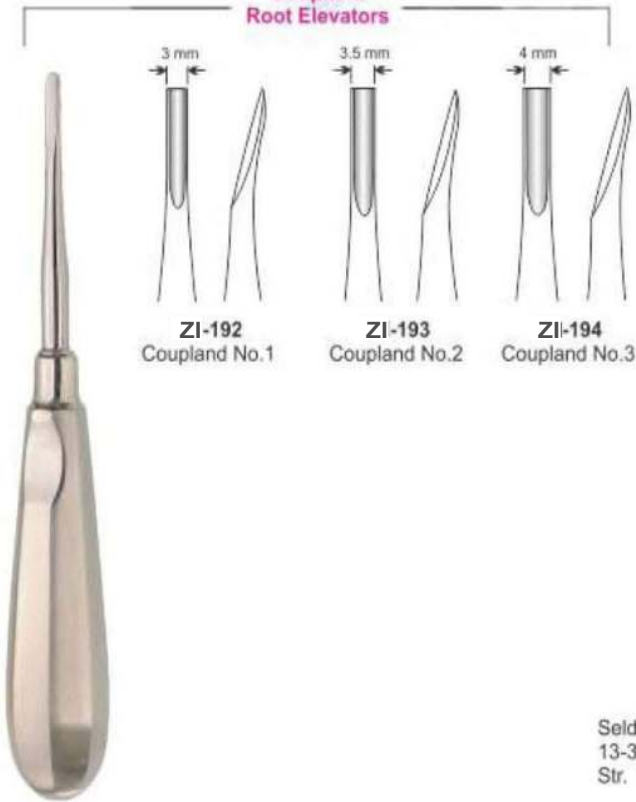

Seldin Root Elevators

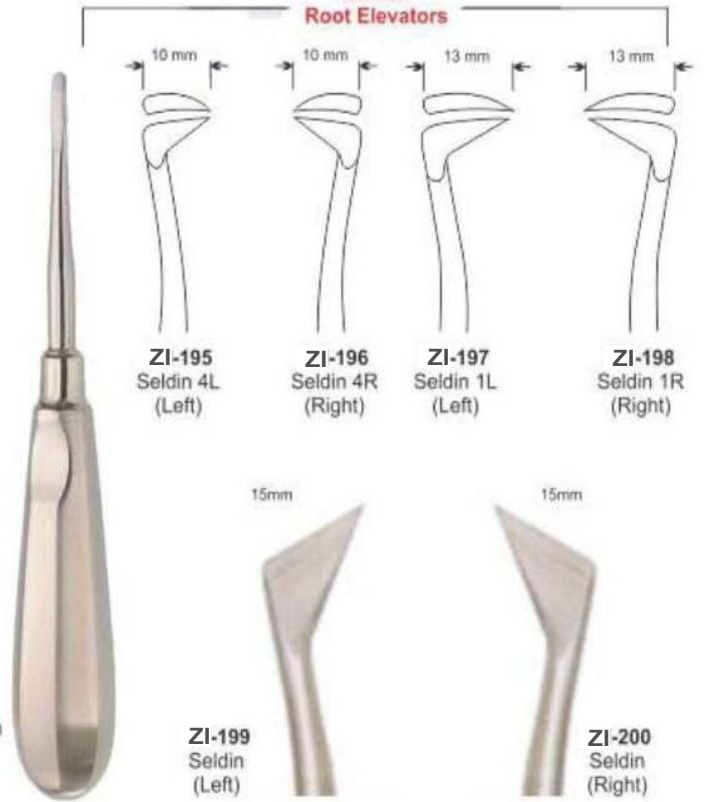

ROOT ELEVATOR

- Элеватор корневой экстракционный
- Elévateurs à racines
- Wurzelheber
- Elevator cornevei ekstraktsionnyy
- Elevadores para raices
- المصاعد الجذر

Apical Root Elevators

Apical Root Elevators

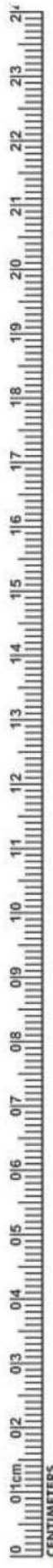

Coupland Root Elevators

Seldin Root Elevators

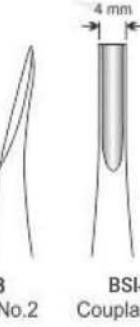
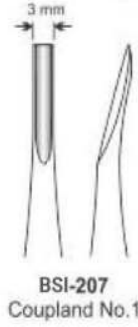

ROOT ELEVATOR

- Элеватор корневой экстракционный
- Elévateurs à racines
- Wurzelheber
- Elevator corneviu extracționii
- Elevadores para raices
- المصاعد الجذر

Apical Root Elevators

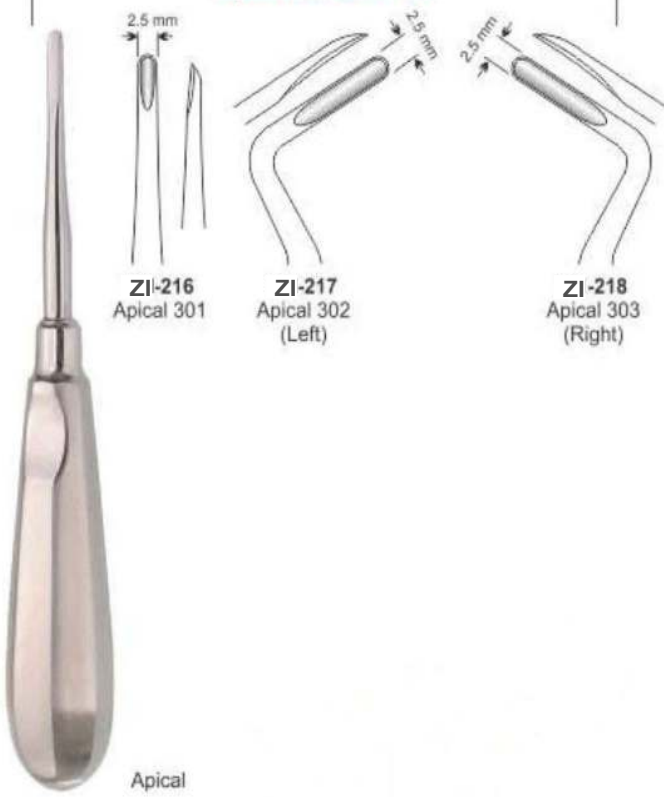

Apical Root Elevators

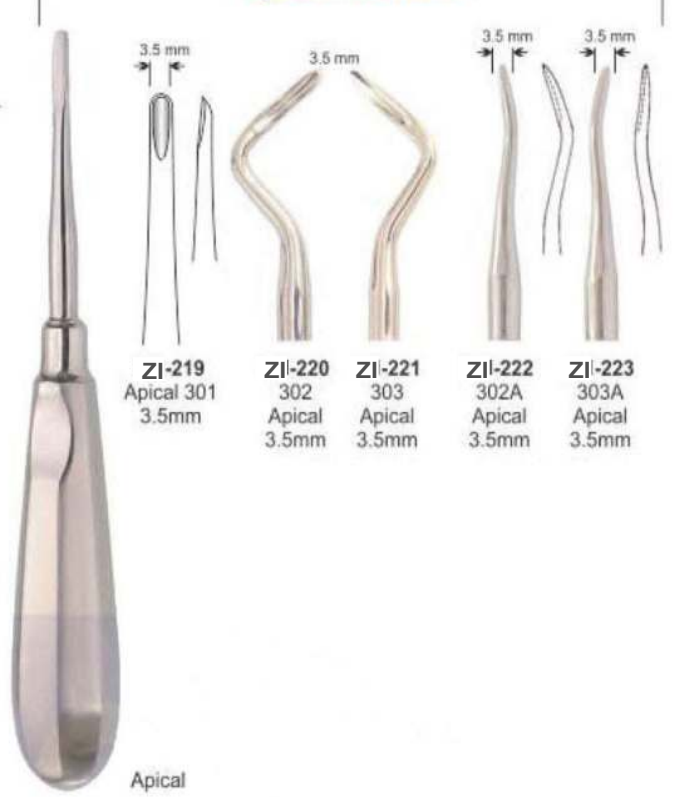

Apical Root Elevators

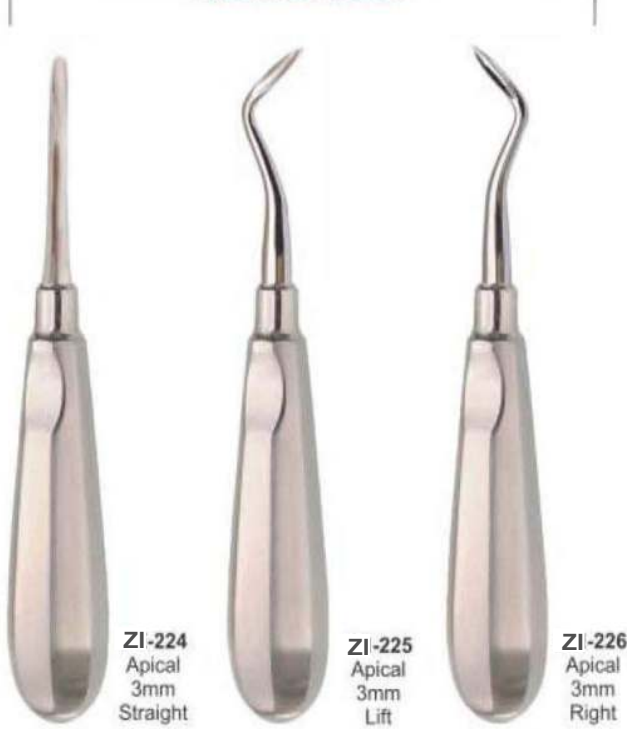

Laxutor Root Elevators

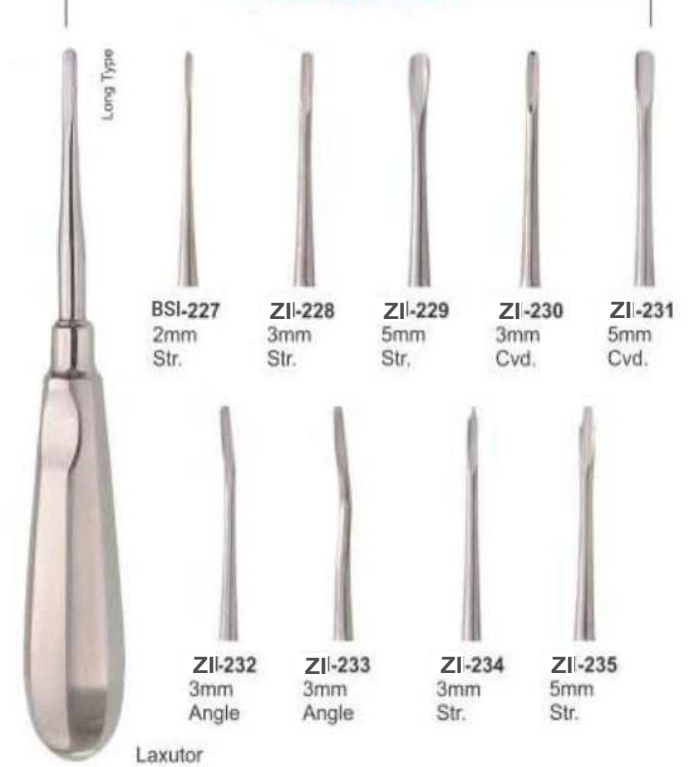

ROOT ELEVATOR

- Элеватор корневой экстракционный
- **Élévateurs à racines**
- Wurzelheber

- Elevator cornevier extracționii
- Elevadores para raíces
- المصاعد الجذر

Lindo Levian Root Elevators

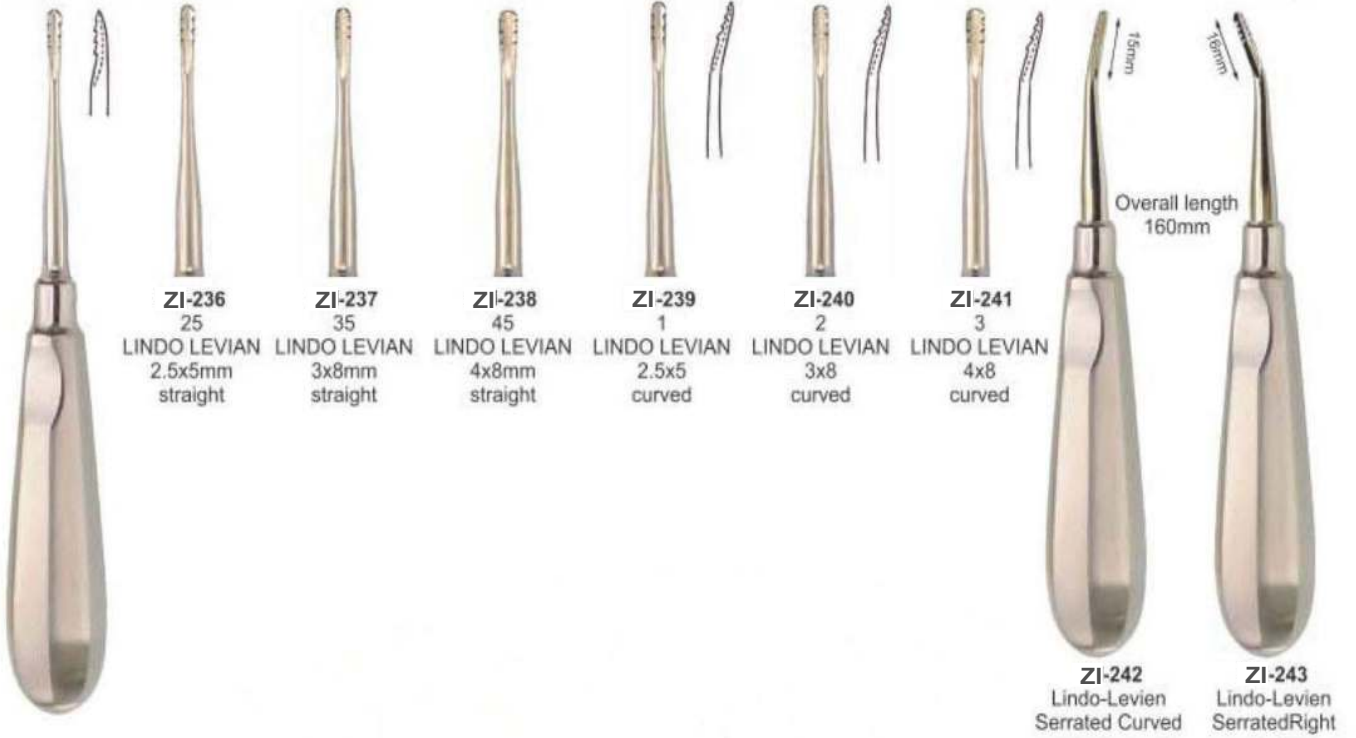

Flohr Root Elevators



Heidbrink Root Elevators

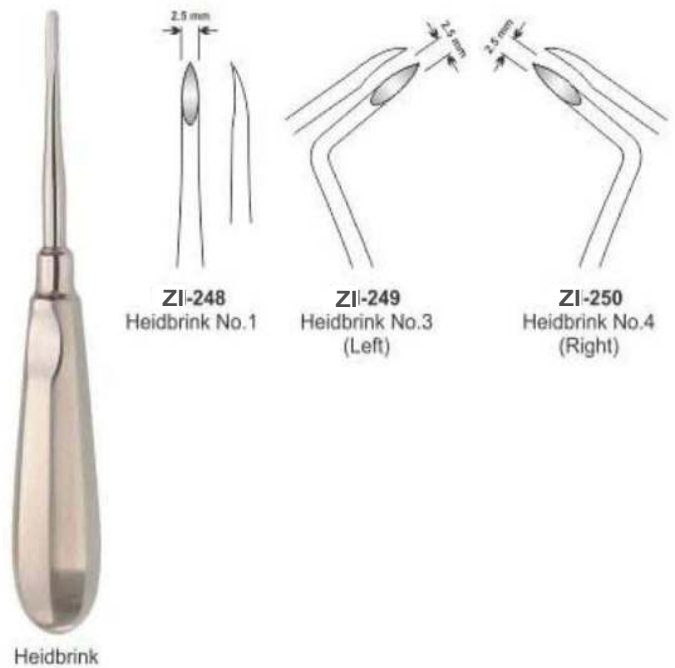

ROOT ELEVATOR

- Элеватор корневой экстракционный
- Elévateurs à racines
- Wurzelheber
- Elevator corneviu extracționiu
- Elevadores para raices
- المصاعد الجذر

Friedmann Roots Elevator



ZI-251 Friedmann 4F Str.
 ZI-252 Friedmann 5F Left
 ZI-253 Friedmann 6F Right

Heidbrink Roots Elevator



ZI-254 Heidbrink Straight
 ZI-255 Heidbrink Left
 ZI-256 Heidbrink Right

Wisdom Roots Elevator



ZI-257 Wisdom for 18 and 38
 ZI-258 Wisdom for 28 and 48

Bayonet Roots Elevator Set



ZI-259 Left
 ZI-260 Right
 ZI-261 bayonet
 ZI-262 Curved
 ZI-263 Straight

Luxator Roots Elevator



ZI-264 Luxator Straight
 ZI-265 Luxator Curved



ROOT ELEVATOR

- Элеватор корневой экстракционный
- Elévateurs à racines
- Wurzelheber
- Elevator corneviu extracționii
- Elevadores para raíces
- المصاعد الجذر

Roots Elevator

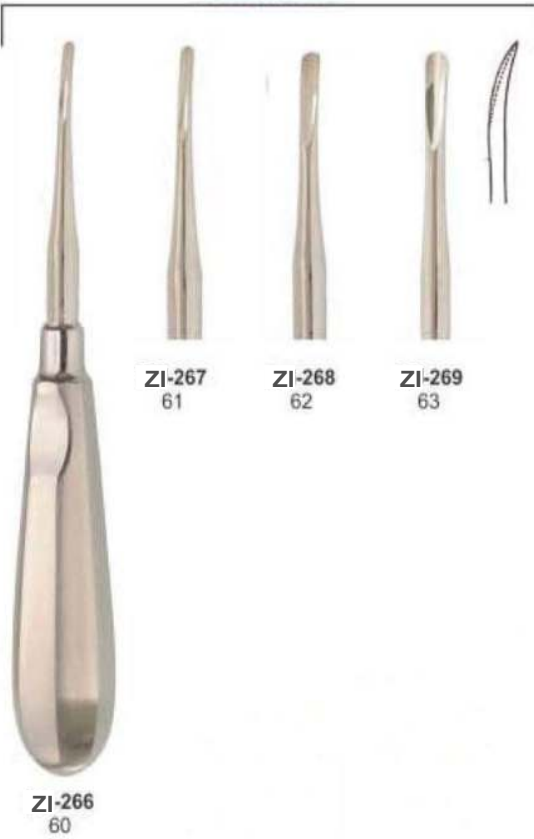

Luxier Roots Elevator



Luxier Roots Elevator

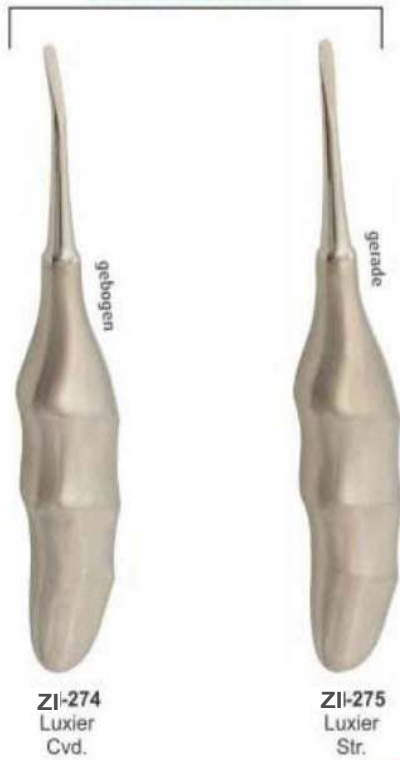

Claw-Lift Roots Elevator

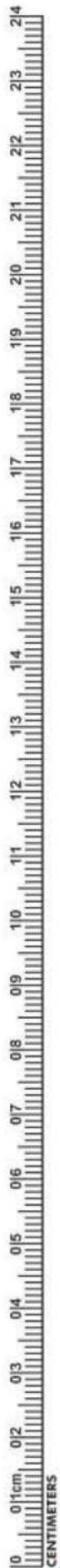

ROOT ELEVATOR

- Элеватор корневой экстракционный
- Elévateurs à racines
- Wurzelheber
- Elevator corneviu extracționii
- Elevadores para raíces
- المصاعد الجذر

Hyllin Roots Elevator



Cryer Roots Elevator



Kopp Roots Elevator



ROOT ELEVATOR

- Элеватор корневой экстракционный
- Élévateurs à racines
- Wurzelheber

- Elevador cornevoй экстракционный
- Elevadores para raices
- المصاعد الجذر

Kopp Roots Elevator



ZI-295
Kopp
Right

ZI-296
Kopp
Left

Heber Roots Elevator



ZI-297
Heber
Bayonet

ZI-298
Heber
Bayonet

Bein Roots Elevator



ZI-299
Bein,
3mm

ZI-300
Bein,
4mm

Bein Roots Elevator



ZI-302
2mm
straight
serrated

ZI-303
3mm
straight

ZI-304
4mm
Curved

ZI-306
2mm
straight
serrated

ZI-307
3mm
straight

ZI-308
4mm
Curved

ZI-310
2mm
straight
serrated

ZI-311
3mm
straight

ZI-312
4mm
Curved

ZI-301
Bein
2mm, curved
serrated

ZI-305
Bein
2mm, curved
serrated

ZI-309
Bein
2mm, curved
serrated

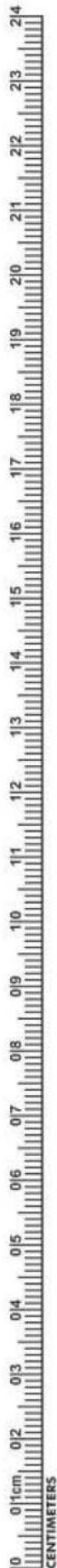

ROOT ELEVATOR

- Элеватор корневой экстракционный
- Elévateurs à racines
- Wurzelheber
- Elevator corneviu extracționii
- Elevadores para raíces
- المصاعد الجذر

Seldin Roots Elevator

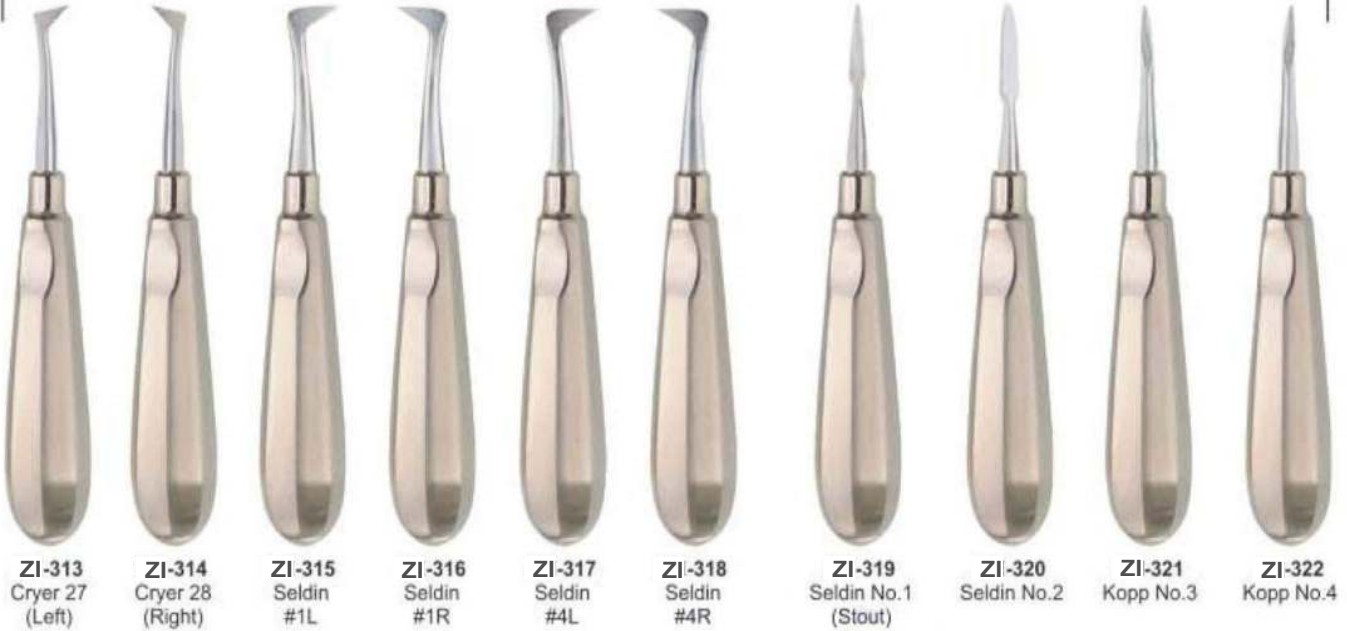

W. Barry Roots Elevator



Winter Roots Elevator



Pott Roots Elevator



ROOT ELEVATOR

- Элеватор корневой экстракционный
- Élévateurs à racines
- Wurzelheber

- Elevator cornevier extrакційний
- Elevadores para raices
- المصاعد الجذر

Heidbrink Roots Elevator



ZI-338
Heidbrink
Straight

ZI-339
Heidbrink
Left

ZI-340
Heidbrink
Right

ZI-341
Heidbrink
Straight

ZI-342
Heidbrink
Left

ZI-343
Heidbrink
Right

Syndesmotomes Roots Elevator



ZI-344
Straight

ZI-345
Left

ZI-346
Right

Periotome Roots Elevator

Syndesmotomes



ZI-347
Periotome
2.1mm
Straight

ZI-348
Periotome
2.6mm
Straight

ZI-349
Periotome
2.1mm
Angular

ZI-350
Periotome
2mm
Curved

ZI-351
Periotome
2.0mm

ZI-352
Periotome
2.5mm

ZI-353
Periotome
3.0mm

ZI-354
Periotome
4.0mm

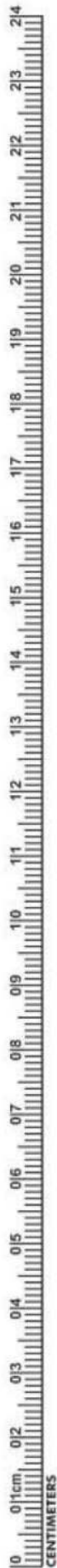

ROOT ELEVATOR

- Элеватор корневой экстракционный
- Elévateurs à racines
- Wurzelheber
- Єлеватор кореневий екстракційний
- Elevadores para raíces
- المصاعد الجذر



ZI-355
1S
(Straight 1mm)



ZI-356
2S
(Straight 2mm)



BSI-357
3S
(Straight 3mm)



ZI-358
5S
(Straight 5mm)



ZI-359
3C
(Curved 3mm)



ZI-360
5C
(Curved 5mm)



ZI-361
3CA
(Curved Angle 3mm)



ZI-362
3IC
(Inverted Curved 3mm)



ZI-363
DE 3
(Dual Edge 3mm / 1.5mm)



ZI-364
DE 5
(Dual Edge 5mm / 3mm)



ROOT ELEVATOR

- Элеватор корневой экстракционный
 - Elévateurs à racines
 - Wurzelheber
- PDL ELEVATORS**

- Elevator cornevei ekstraktsionniy
- Elevadores para raices
- المصاعد الجذر

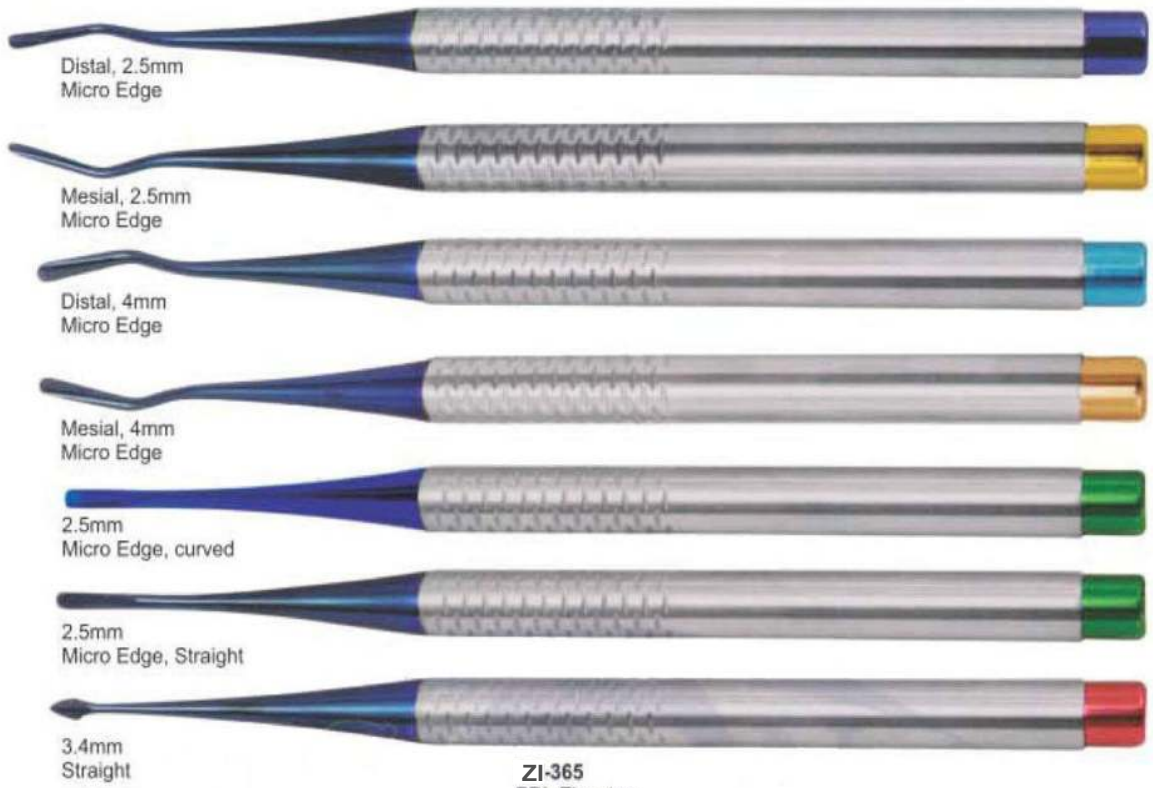
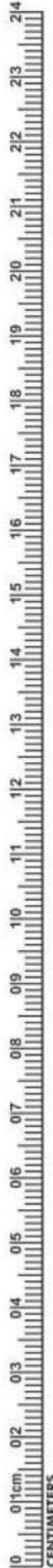

Distal, 2.5mm
Micro Edge

Mesial, 2.5mm
Micro Edge

Distal, 4mm
Micro Edge

Mesial, 4mm
Micro Edge

2.5mm
Micro Edge, curved

2.5mm
Micro Edge, Straight

3.4mm
Straight

ZI-365
PDL Elevators
Set of 7 Pcs



Distal, 4mm
Micro Edge

Mesial, 4mm
Micro Edge

Distal, 2.5mm
Micro Edge

Mesial, 2.5mm
Micro Edge

2.5mm
Micro Edge, curved

2.5mm
Micro Edge, Straight

3.4mm
Straight

ZI-366
PDL Elevators
Set of 7 Pcs

ROOT ELEVATOR

- Элеватор корневой экстракционный
- Elevateurs à racines
- Wurzelheber
- Elevator corneviy ekstraktsionniy
- Elevadores para raices
- المصاعد الجذر

PDL ELEVATORS

Delicate Arrow tip



4,0mm straight
4,0mm curved

Luxivators straight
atraumatic luxation of the tooth

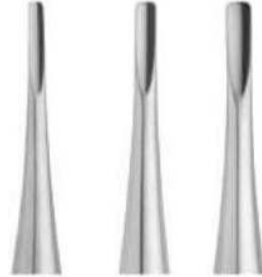

2,5mm straight
3,5mm straight
4,5mm straight

Luxivators curved
atraumatic luxation of the tooth



2,5mm curved
3,5mm curved
4,5mm curved



ZI-367
PDL Elevators
Set of 8 Pcs



INCHES

Our Scalers

Compare our scalers and curettes with the best in the industry and you will immediately recognize we are equal in every way but one... price. Note the deep precision knurling for better tactile feel. The same high-grade stainless steel tips, the same light weight (under 18 grams) for less hand fatigue, the same professional craftsmanship, and surpassing the highest industry standards. Of course, any manufacturer can make these claims, but we guarantee and certify ours.

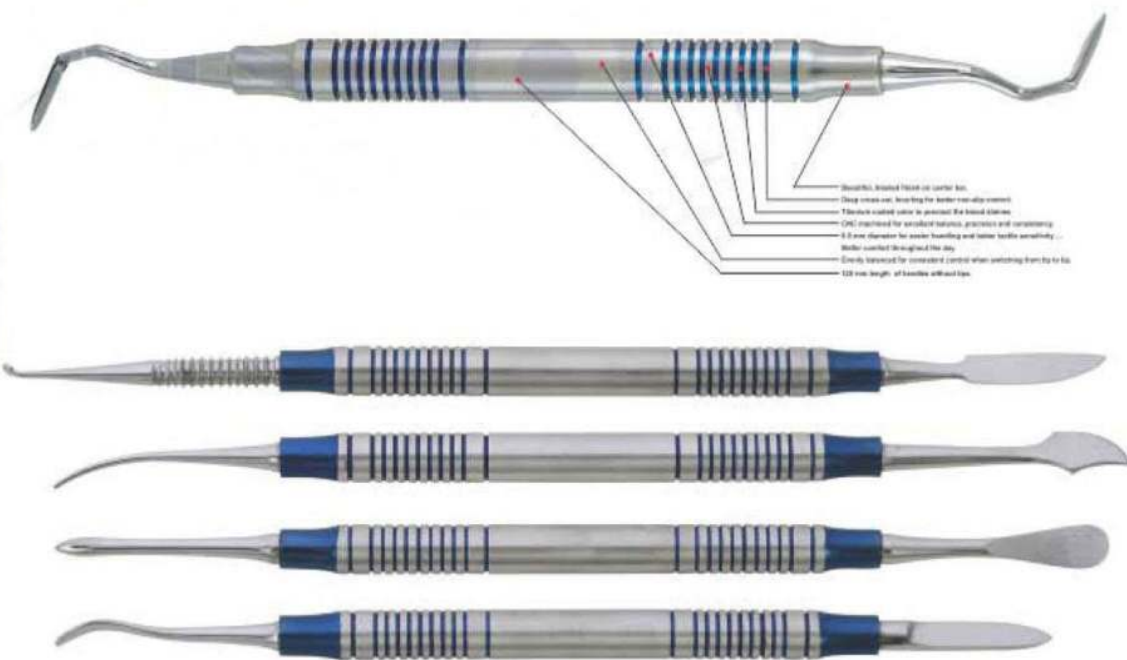
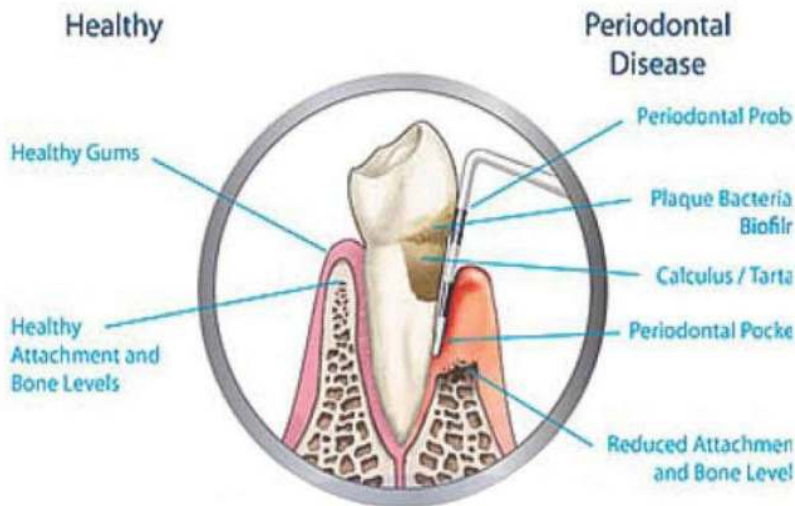

- Smooth, knurled finish on handle for better tactile feel.
- Deep mirror on handle for better tactile feel.
- Titanium coated color to protect the metal surface.
- CNC machined for excellent balance, precision and consistency.
- 3.0mm diameter for easier handling and better tactile sensitivity.
- Mirror polished throughout the day.
- Easily balanced for consistent control when performing from tip to base.
- 128 mm length of handle without tip.

- High-polish mirror finish tips.
- Manufactured within the guidelines of the FDA quality assurance system for good manufacturing practices.
- Highest grade German stainless steel, razor sharp, durable tips. Rockwell hardened to 60 RHC.
- 27 of the most popular designs from Graceys to McCalls to Columbias, and many European patterns.
- All instruments are guaranteed against defects in material and workmanship.

- All instruments bear the CE mark, emblematic of the European Community's highest standards.
- Customer satisfaction guarantee, too!
- Less than 20 grams ... Lightweight for less hand fatigue.
- Manufactured to the most exacting standards so the 50th instrument you buy is exactly like your first.
- You decide ... Why pay more for the same high-quality instruments?

HANDLES FOR MOUTH MIRRORS

- Ручки для зеркал
- Manches pour miroirs à bouche
- Mundspiegelgriffe
- Ручки для дзеркал
- Mangos para espejos de boca
- مقابض لمرآة الفم



Magnifying

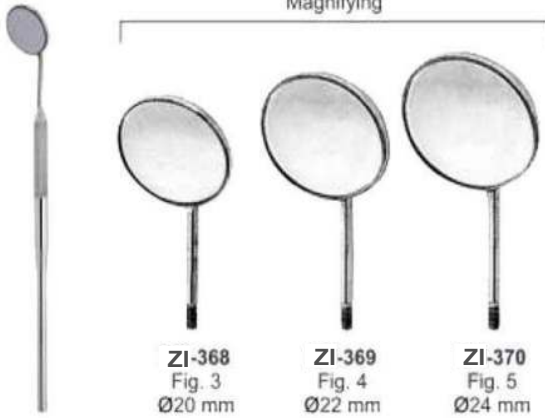

Plain

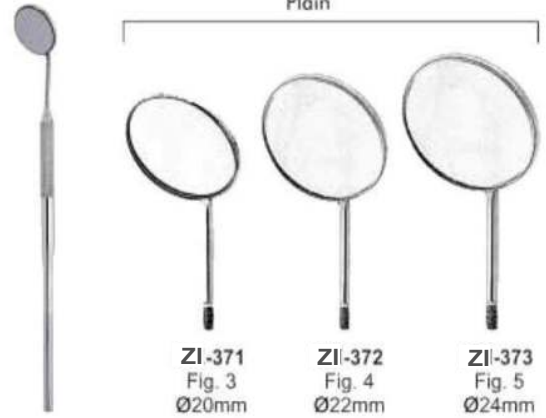

Rhodium

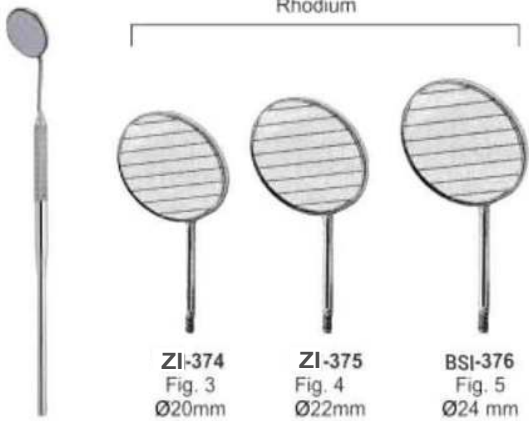

TWEEZERS

- Пинцеты
- Précelles - Brucelles
- Zahnpinzetten

- Пинцети
- Pinzas para algodón
- ملاقط



ZI-381
Surgical
11.5cm



ZI-382
London College
15cm



ZI-383
Semken Taylor
Str.



ZI-384
Semken Taylor
Cvd.



ZI-385
Meriam
16cm



ZI-386
Dressing
14cm



ZI-387
Semken Taylor
1x2 Straight



ZI-388
Semken Taylor
1x2 Curved



ZI-389
Gilles
15cm 1x2



ZI-390
14cm 1x2



ZI-391
Perry
13cm



ZI-392
Atraumatic
15cm Cvd



ZI-393
Atraumatic
15cm Str.



ZI-394
College with Lock
15cm Cvd.



BSI-395
Gerald
17.5cm



ZI-396
with lock
15cm



ZI-397
Atraumatic
17.5cm

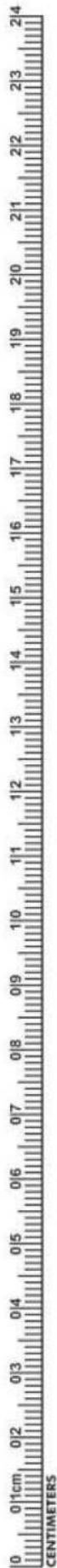

TWEEZERS

- Пинцеты
- Prêcelles - Brucelles
- Zahnpinzetten

- Пинцети
- Pinzas para algodón
- ملاقط



ZI-398
Adson-TC
12cm



ZI-399
Adson-TC
12cm 1x2



ZI-400
Adson-TC
15cm 1x2



ZI-401
Adson
12cm



ZI-402
Adson
12cm 1x2



ZI-403
Adson
15cm 1x2



ZI-404
Adson Brown
12cm



ZI-405
Crane Kaplan
15cm



ZI-406
Crane Kaplan
15cm



ZI-407
Crane Kaplan
15cm



ZI-408
Hemingway
15cm



ZI-409
Miller
15cm Str.



ZI-410
Miller
15cm Cvd.



ZI-411
Dressing
Tweezer
14.5cm



ZI-412
College
Curved
Tip 15cm



ZI-413
Maryam
Tweezers
15cm



ZI-414
College
Tweezer
15cm



ZI-415
Perry
Tweezer
12.5cm



ZI-416
Self-locking
Tweezer
15cm



INCHES

EXPLORERS

- Зонды
- Sondes
- Zahnsonden
- Зонди
- Sondas
- المستكشفين

Single Ended Probe Solid Handle 4.5mm Length 150mm



Fig. 2
Normal Handle

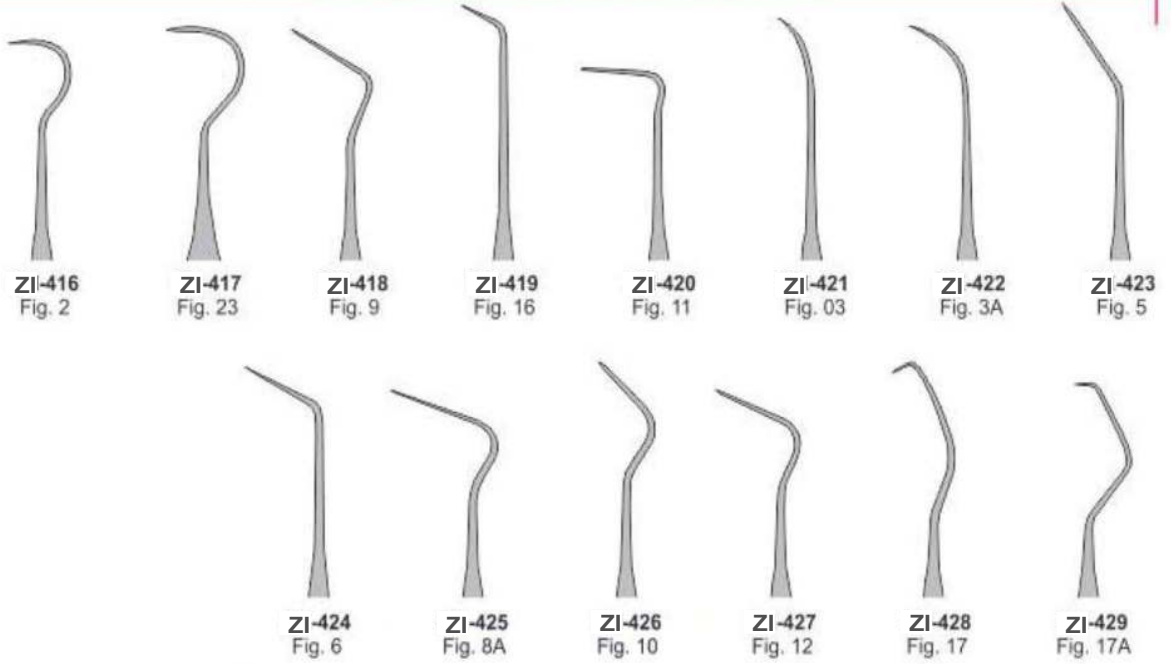

Single Ended Probe Hollow Handle 8.5mm Length 150mm



Fig. 2
Anatomic Handle

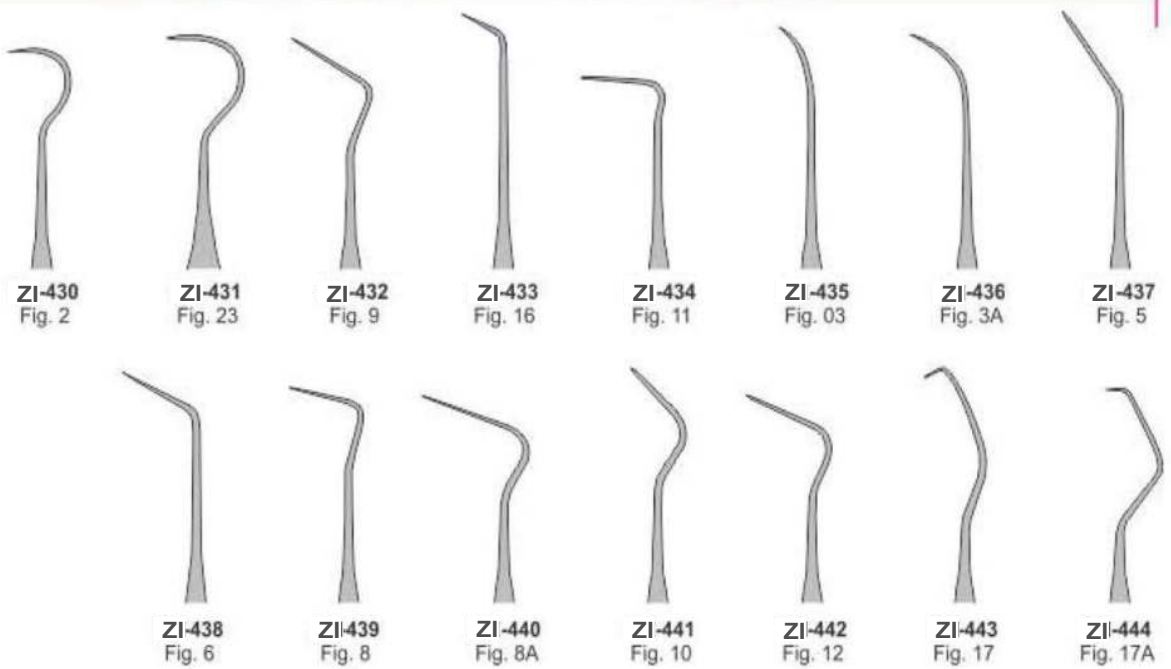

EXPLORERS

- Зонды
- Sondes
- Zahnsonden
- Зонди
- Sondas
- المستكشفين

Probes Single End Solid Handle 6mm, length 150mm

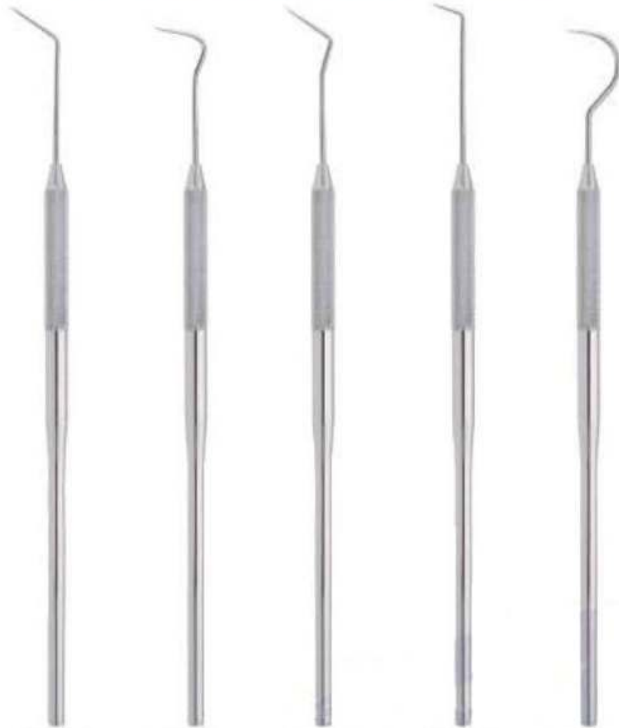

ZI-445 Fig. 6 ZI-446 Fig. 8 ZI-447 Fig. 9 ZI-448 Fig. 16 ZI-449 Fig. 23

Probes Single Ended 6mm, length 150mm

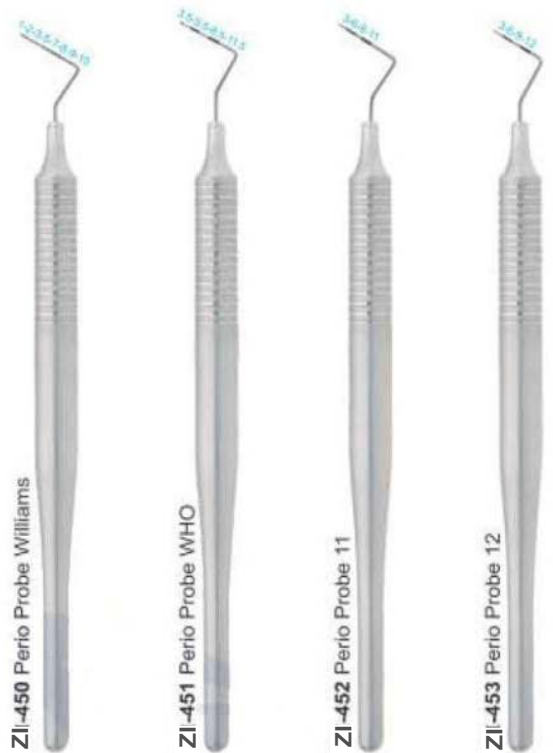

ZI-450 Perio Probe Williams ZI-451 Perio Probe WHO ZI-452 Perio Probe 11 ZI-453 Perio Probe 12

Examination kit Set of 3 Pieces



ZI-454 Probe ZI-455 Mirror ZI-456 College Forcep 15cm

Examination Set of 4 Pieces



Examination Set of 4 Pieces



ZI-457 Exp,23/17-A ZI-458 Exavators ZI-459 Tweezers ZI-460 Mouth Mirror



INCHES

EXPLORERS

EXPLORERS INSTRUMENTS SOLID HANDLE 6MM, LENGTH 170MM

- Зонды
- Sondes
- Zahnsonden
- Зонди
- Sondas
- المستكشفين

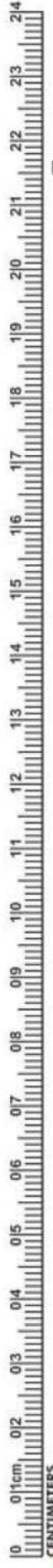

Double-Ended Explorers

Explorers-Single-End

Tip Size: 1/1

Solid Handle Size 4.25"

15-14-13-12-11-10-9-8-7-6-5-4-3-2-1

<p>ZI-463 TU 17/23 Wilkins/Tufts Explorer #6</p>	<p>ZI-464 23/UNC1 university of north carolina Explorer #31, #6, #7, #8</p>	<p>ZI-465 1 #31, #6</p>	<p>ZI-466 DG 16 #31, #6, #7 Thick, #6</p>	<p>ZI-467 DG 16/23</p>	<p>ZI-468 DG 16/17</p>	<p>ZI-469 1 Abou-Rass Explorers</p>
---	--	--	--	-----------------------------------	-----------------------------------	--

Probes Double Ended 6mm, length 170mm

<p>ZI-470 Goldman Fox Fig.17</p>	<p>ZI-471 University of Michigan Fig.17</p>	<p>ZI-472 Williams Fig.17</p>	<p>ZI-473 Goldman Fox Fig.16</p>	<p>ZI-474 University of Michigan Fig.16</p>	<p>ZI-475 Williams Fig.16</p>
---	--	--	---	--	--

EXPLORERS

- Зонды
- Sondes
- Zahnsonden
- Зонди
- Sondas
- المستكشفين

Pointed Probes Single Ended Handle 6mm, length 150mm



Pointed Probes Double Ended Handle 6mm, length 170mm



PERIODONTAL INSTRUMENTS

- Инструменты пародонтологические
- Instruments pour la parodontologie
- Instrumente für die Parodontologie

- Інструменти пародонтологічні
- instrumentos para periodoncia
- الصكوك اللثة

PERIODONTAL SET OF 10 PIECES SOLID HANDLE 6MM LENGTH 170MM

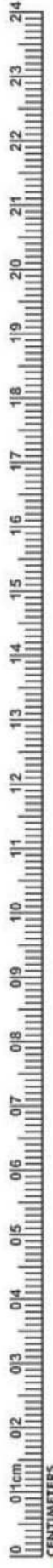

ZI-488 MOUTH MIRROR

ZI-489 EXP.23/17-A

ZI-490 EXAVATORS

ZI-491 Filling Instruments

ZI-492 EXP.23/CP-18

ZI-493 EXP.23/CP-QW

ZI-494 EXP.23/CP-11

ZI-495 EXP.23/CP-10

ZI-496 EXP.23/CP-12

ZI-497 EXP.23/CP-11.5-B

EXPLORERS

- Зонды
- Sondes
- Zahnsonden
- Зонди
- Sondas
- المستكشفين

WILLIAM PROBE SET DOUBLE ENDED WITH HOLLOW HANDLE 9.5MM, LENGTH 170MM
CERAMIC COATED HANDLE

Proper care must be given during cleaning, sharpening and sterilization to preserve design and integrity and to prolong usefulness. Do not expose instruments to sterilization temperatures above 350 F/177 C or to higher than recommended chemical concentrations.

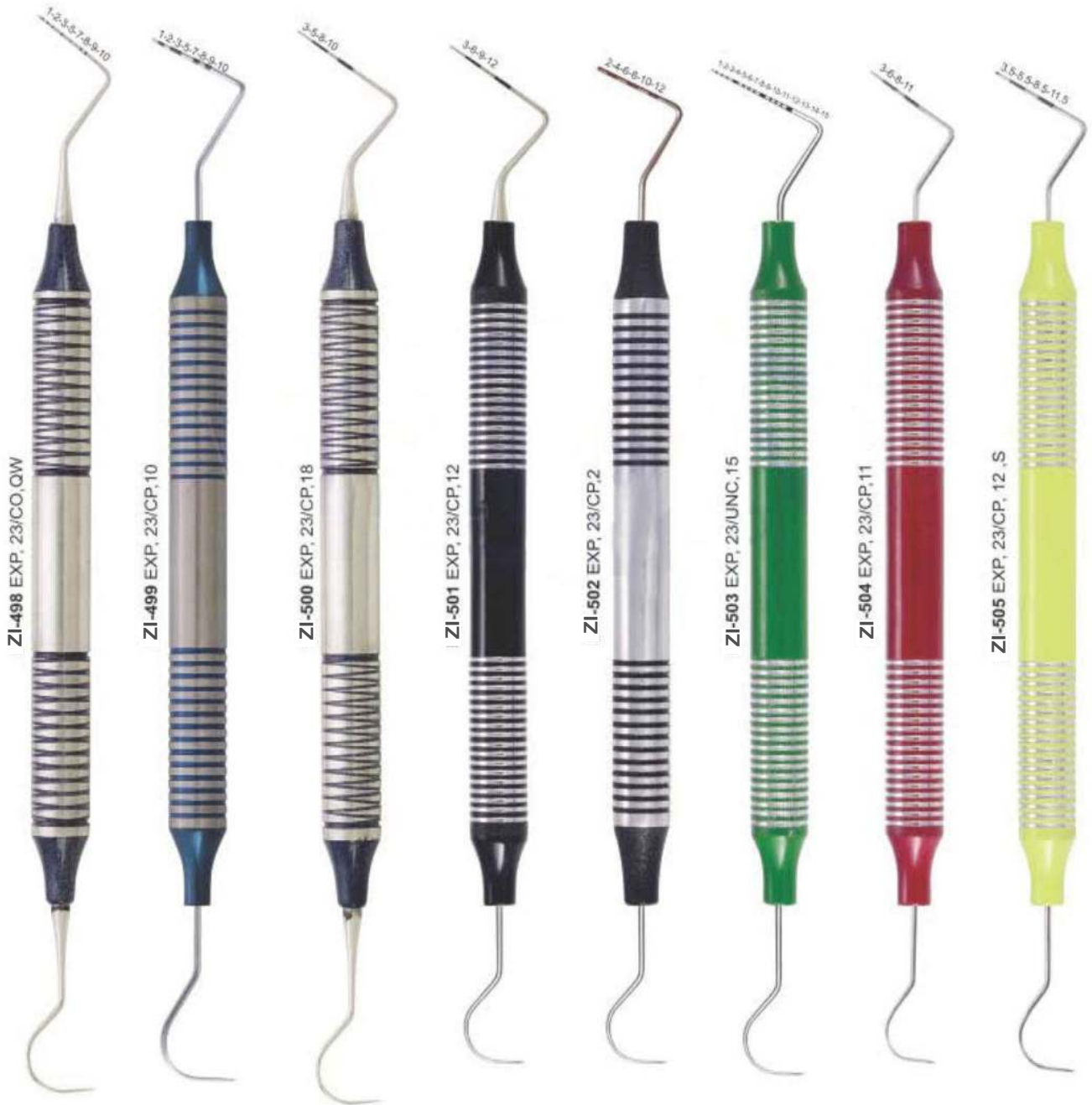

PERIODONTAL INSTRUMENTS

- Инструменты пародонтологические
- Instruments pour la parodontologie
- Instrumente für die Parodontologie

- Інструменти пародонтологічні
- instrumentos para periodoncia
- الصكوك اللثة

PERIODONTAL INSTRUMENTS SET OF 11 PCS SOLID HANDLE 6MM, LENGTH 170MM



125MM

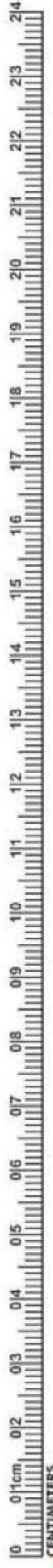

CURETTES

- Кюрети
- Curetas
- Kuretten
- Кюрети
- Curette
- كرنس

GRACEY SET OF 7 PCS HOLLOW HANDLE 9.5MM, LENGTH 170MM

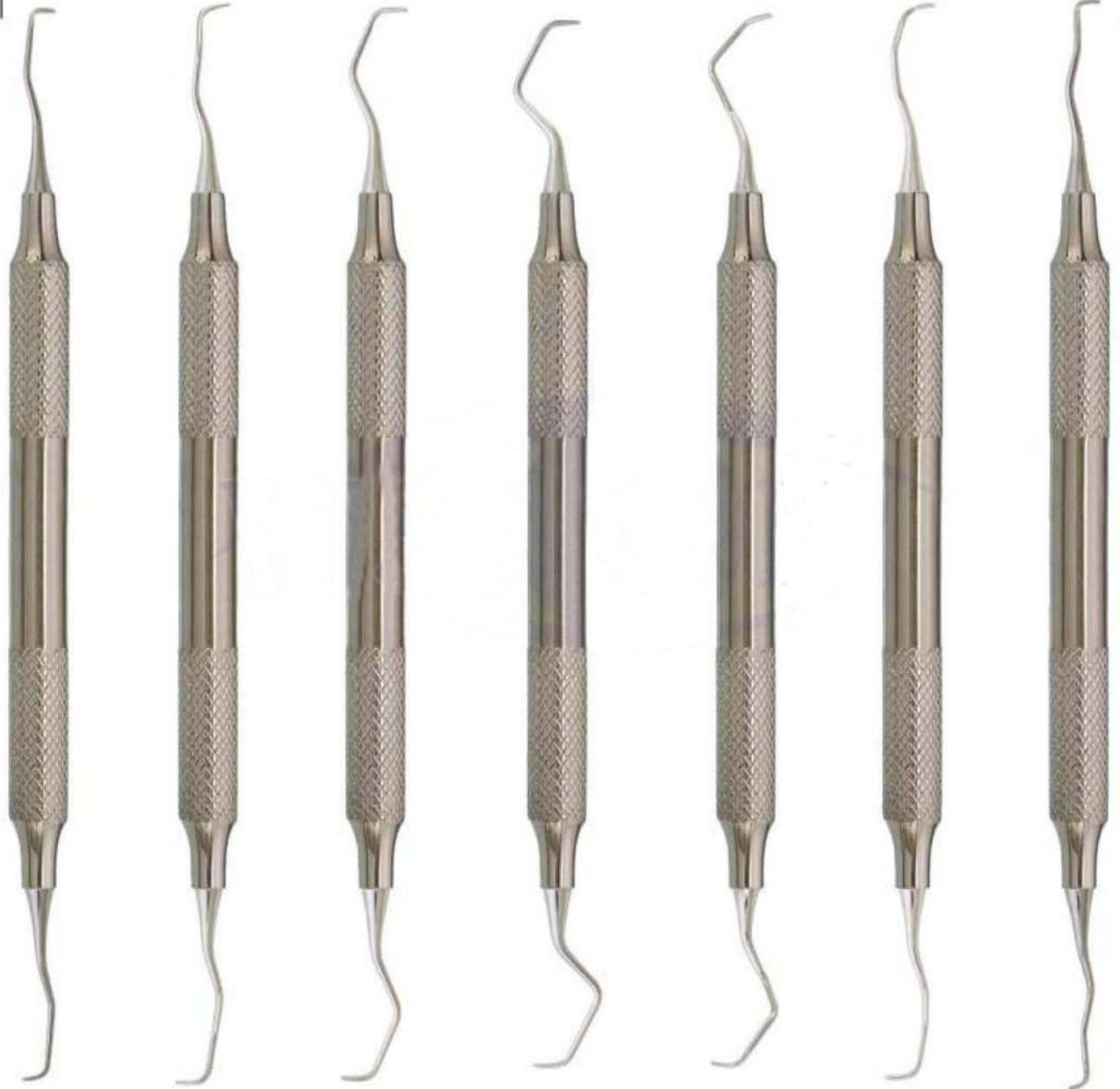

ZI-517
GRACEY
1/2

ZI-518
GRACEY
3/4

ZI-519
GRACEY
5/6

ZI-520
GRACEY
7/8

ZI-521
GRACEY
9/10

ZI-522
GRACEY
11/12

ZI-523
GRACEY
13/14



CURETTES

- Кюрети
- Curetas
- Kuretten

- Кюрети
- Curette
- كرتس

GRACEY SET OF 7 PCS HOLLOW HANDLE 9.5MM, LENGTH 170MM WITH SILICON GRIP

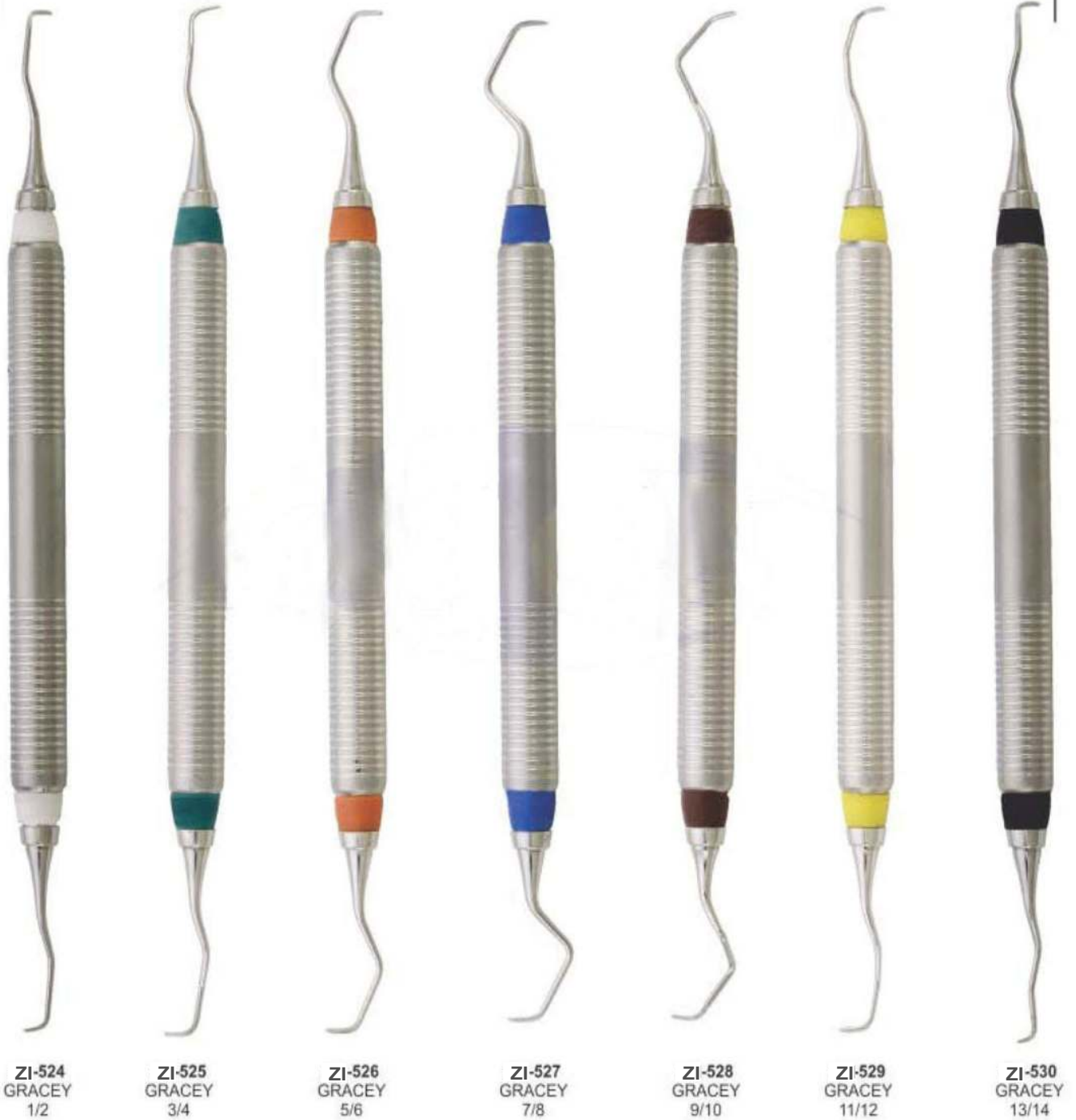

CURETTES

- Кюрети
- Curetas
- Kuretten
- Кюрети
- Curette
- كرنس

GRACEY MINI FIVE

HOLLOW HANDLE 9.5MM, LENGTH 170MM
CERAMIC COATED HANDLE



ZI-531	ZI-532	ZI-533	ZI-534	ZI-535	ZI-536
Gracey	Gracey	Gracey	Gracey	Gracey	Gracey
1/2	3/4	5/6	7/8	11/12	13/14

GRACEY AFTER FIVE

HOLLOW HANDLE 9.5MM, LENGTH 170MM
CERAMIC COATED HANDLE



ZI-537	ZI-538	ZI-539	ZI-540	ZI-541	ZI-542
Gracey	Gracey	Gracey	Gracey	Gracey	Gracey
1/2 AF	3/4 AF	5/6 AF	7/8 AF	11/12 AF	13/14 AF

Proper care must be given during cleaning, sharpening and sterilization to preserve design and integrity and to prolong usefulness. Do not expose instruments to sterilization temperatures above 350 F/177 C or to higher than recommended chemical concentrations.



INCHES

CURETTES

- Кюрети
- Curetas
- Küretten
- Кюрети
- Curette
- کرتس

GRACEY CURETTE HOLLOW HANDLE 10MM, LENGTH 170MM

Curetters Set of 8 Pieces

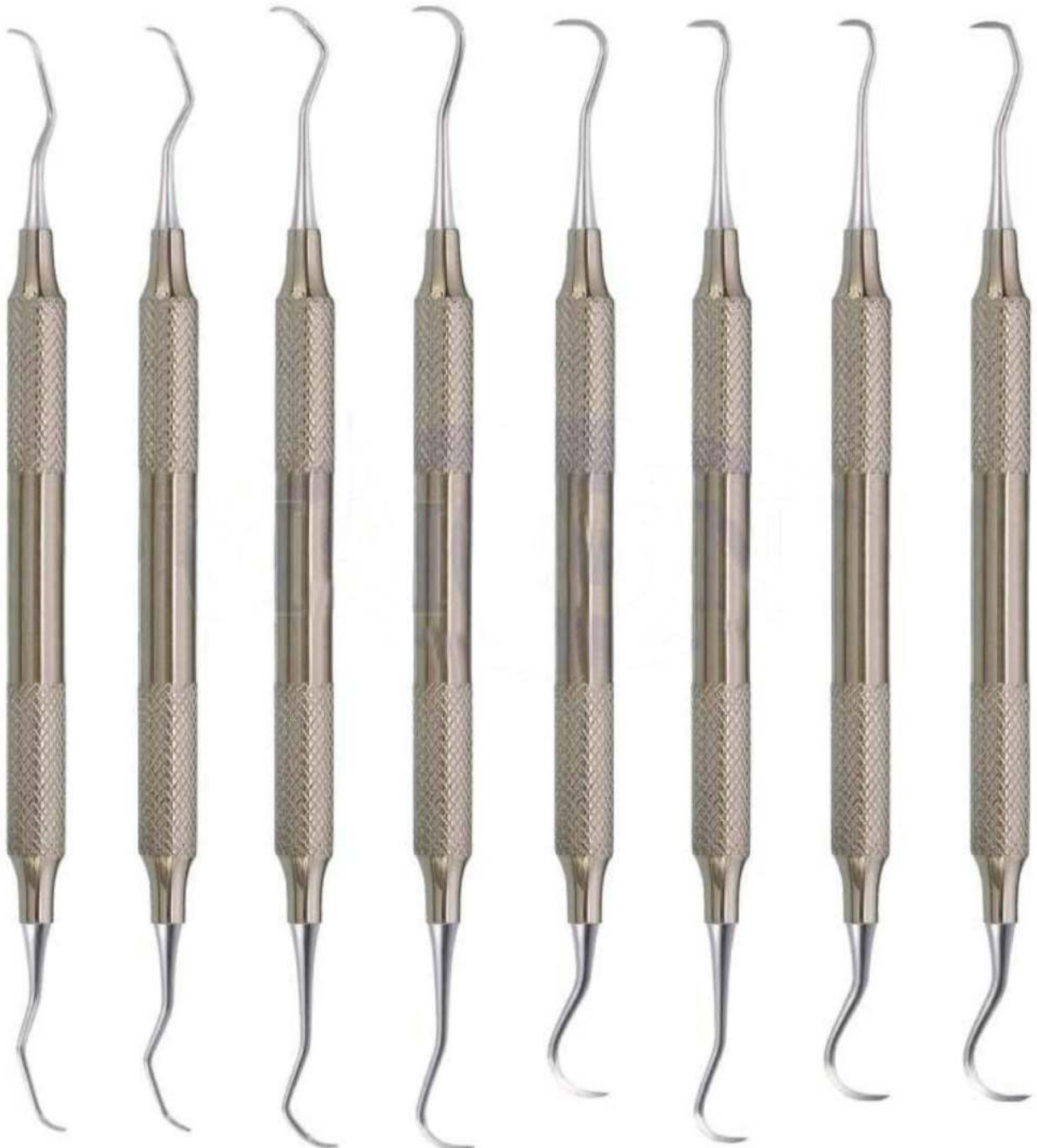

ZI-543
Curette
Columbia
2L-2R

ZI-544
Curette
Columbia
4L-4R

ZI-545
Curette
McCall
13S-14S

ZI-546
H6-H7
Scaler
Sickle

ZI-547
H5-U15
Scaler
Sickle

ZI-548
H5-13
Scaler
Sickle

ZI-549
U15-30
Scaler
Sickle

ZI-550
U15-33
Scaler
Sickle

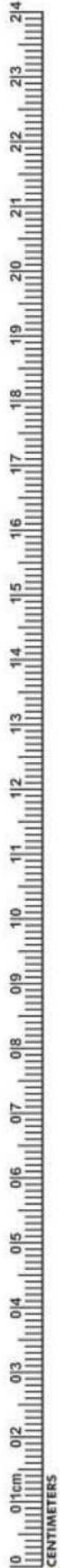

FILLING INSTRUMENTS

- Инструменты для реставрации
- Instruments pour plombage
- Füllungsinstrumente (mit Kontrawinkel)
- Инструменти для реставрації
- Instrumentos para obturaciones
- ملء الصكوك

FILLING INSTRUMENTS (Gold Pointed)
SOLID HANDLE 6MM, LENGTH 170MM



Solid Handle Size 4.25"

Tip Size: 1/1

ZI-551 1.5mm / 1.5mm
ZI-552 2.0mm / 2.0mm
ZI-553 2.0mm / 2.0mm

ZI-554 2.5mm / 2.5mm

ZI-555 1.3mm / 0.9mm
ZI-556 1.6mm / 1.3mm
ZI-557 2.4mm / 1.8mm

ZI-558 2.4mm / 2.0mm
ZI-559 1.3mm / 1.5mm
ZI-560 1.8mm / 1.2mm

Filling instrument, spatula 6 mm solid handle, length 170 mm,

Filling instrument 6 mm length 175 mm,

Filling instrument, ball 6 mm length 170 mm,

Filling instrument, ball / spatula 6 mm length 175 mm,

Filling instrument, plan / plan 6 mm length 165 mm,



EXPLORERS

EXPLORERS INSTRUMENTS SOLID HANDLE 6MM, LENGTH 170MM

- Зонды
- Sondes
- Zahnsonden
- Зонди
- Sondas
- المستكشفين

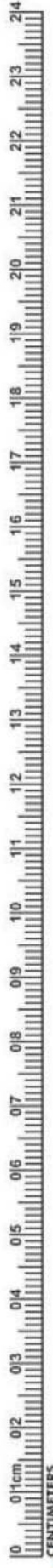

PLUGGERS

.50	1.00	.50	.80
.75	1.15	.60	1.10
ZI-562 5/7 21mm	ZI-563 9/11 21mm	ZI-564 1/2 Root Canal Plugger	ZI-565 3/4 Root Canal Plugger
		.20	.25
		ZI-566 MA57 27mm	ZI-567 GP3 30mm
.30	.40	.50	.60
ZI-568 ISO Size 30 24mm	ZI-569 ISO Size 40 24mm	ZI-570 ISO Size 50 24mm	ZI-571 ISO Size 60 24mm

PERIODONTAL PROBES

- Зонды пародонтологические
- Sondes paradontales
- sonde paradontali
- зонди пародонтологічні
- Sondas paradontales
- المسابر اللثة

SPREADERS

HEAT CARRIERS

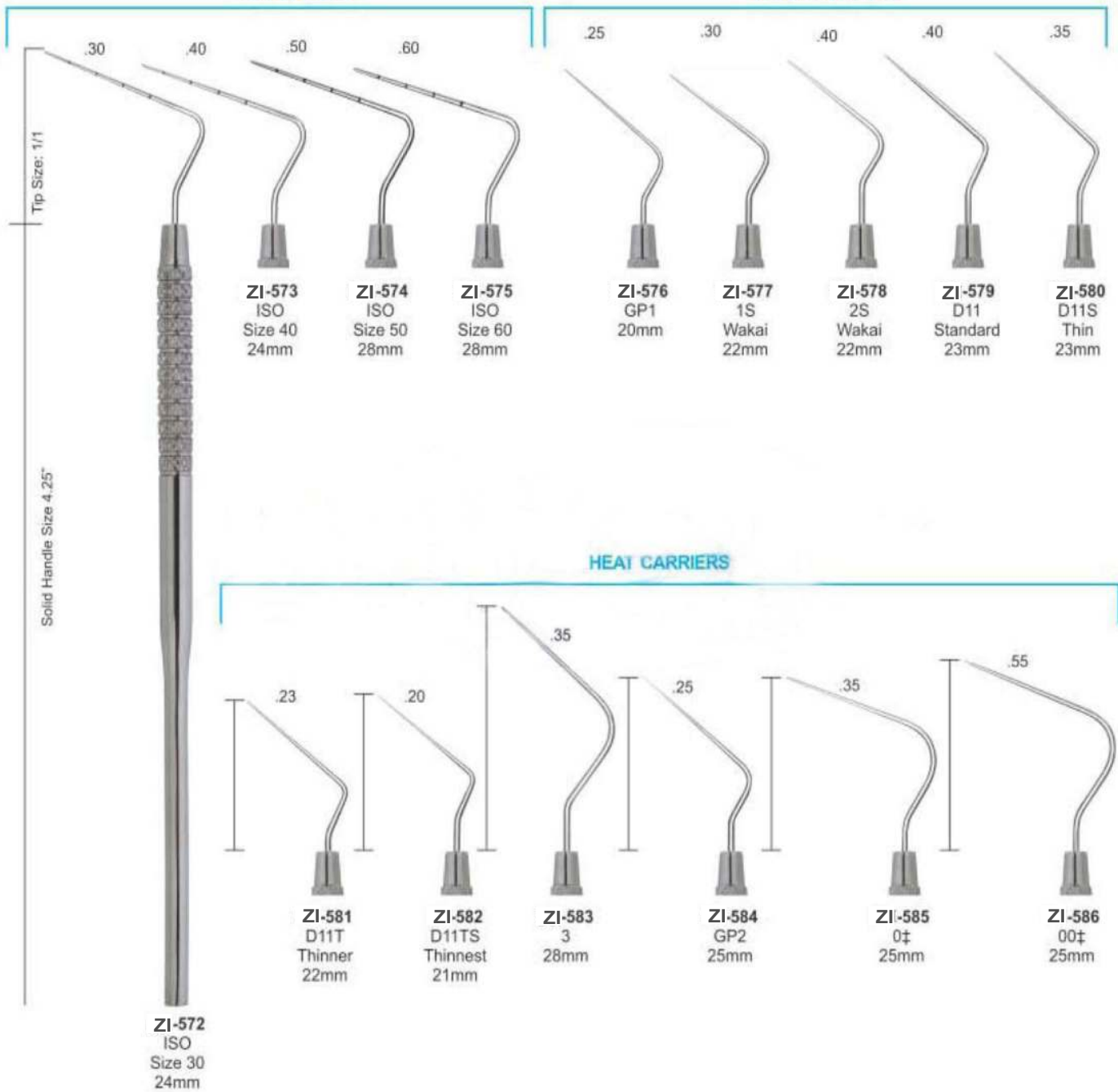

INCHES

PERIODONTAL PROBES

- Зонды пародонтологические
- Sondes paradontales
- sonda parodontali
- зонди пародонтологічні
- Sondas paradontales
- المقاسر اللثة

ENDODONTICS INSTRUMENTS

ANTERIOR

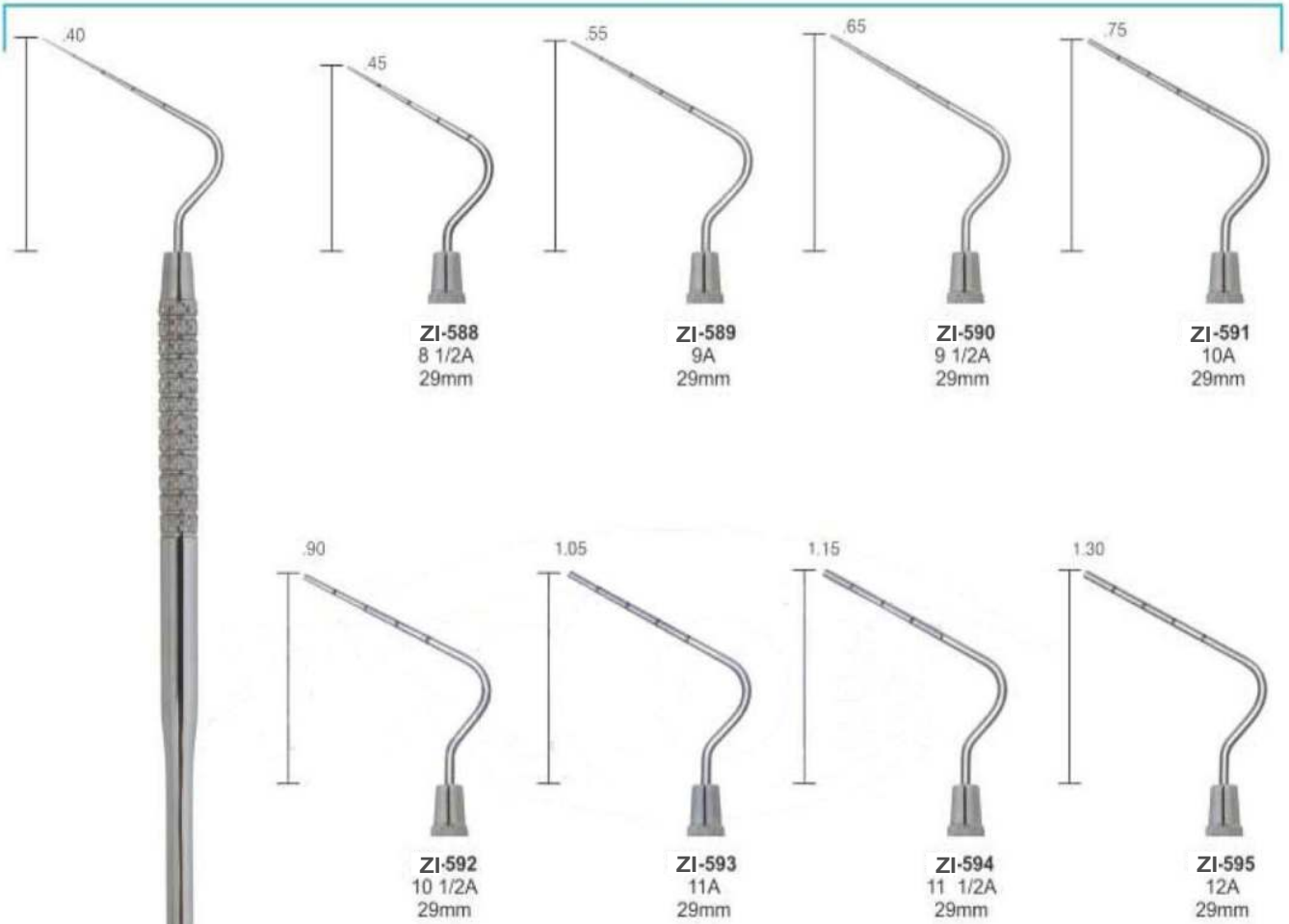

LUKS



0 0.1cm 0.2 0.3 0.4 0.5 0.6 0.7 0.8 0.9 1.0 1.1 1.2 1.3 1.4 1.5 1.6 1.7 1.8 1.9 2.0 2.1 2.2 2.3 2.4
CENTIMETERS

PERIODONTAL PROBES

- Зонды пародонтологические
- Sondes parodontales
- sonda parodontali
- зонди пародонтологічні
- Sondas parodontales
- المسابر اللثة

ENDODONTICS INSTRUMENTS SOLID HANDLE 6MM, LENGTH 170MM POSTERIOR

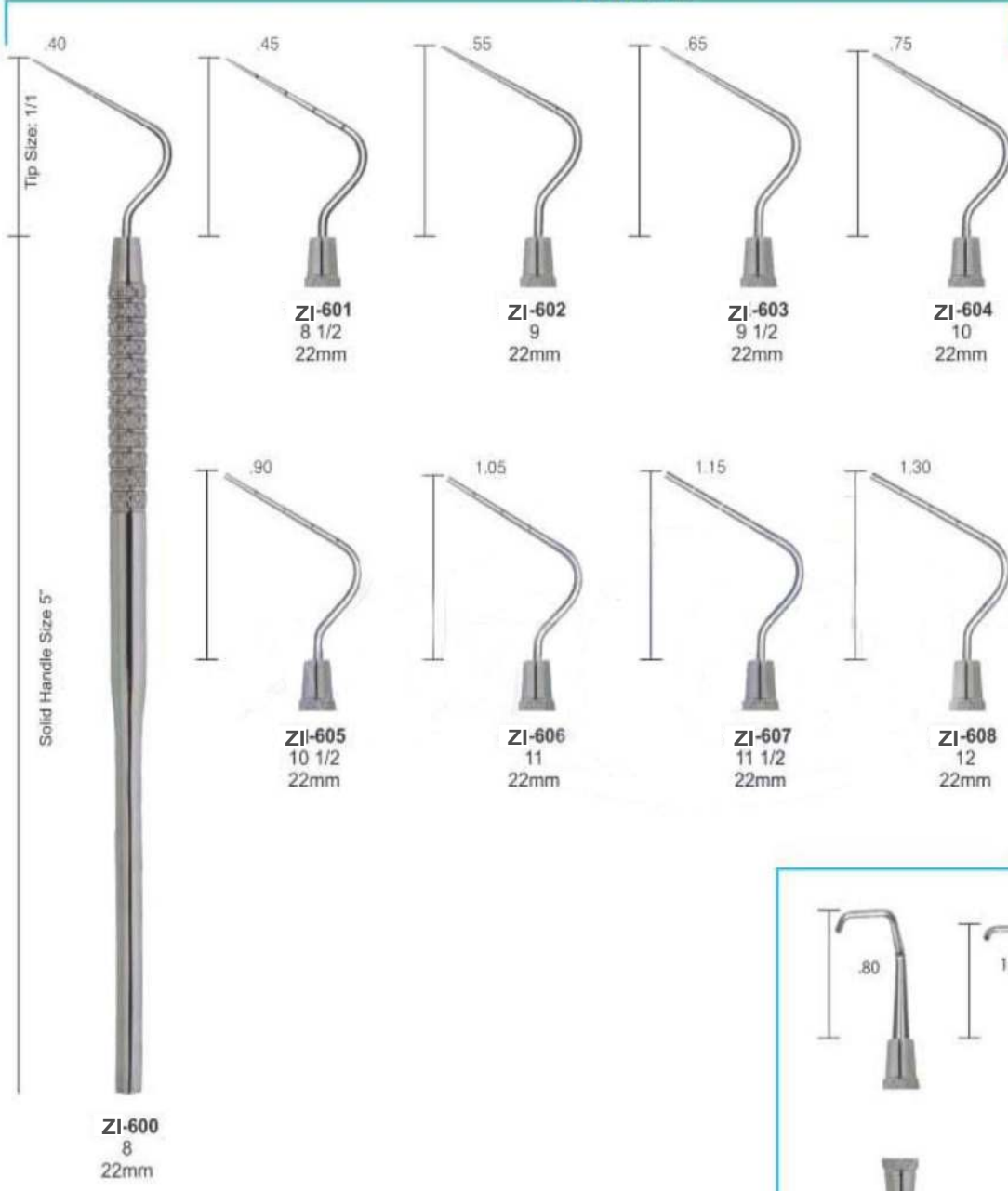

RETRO FILLING PLUGGERS



FILLING INSTRUMENTS

- Инструменты для реставрации
- Instruments pour plombage
- Füllungsinstrumente (mit Kontrawinkel)

- Инструменти для реставрації
- Instrumentos para obturaciones
- ملء الصكوك

COMPOSITE/PLASTIC FILLING INSTRUMENTS SOLID HANDLE 6MM, LENGTH 170MM

POSTERIOR

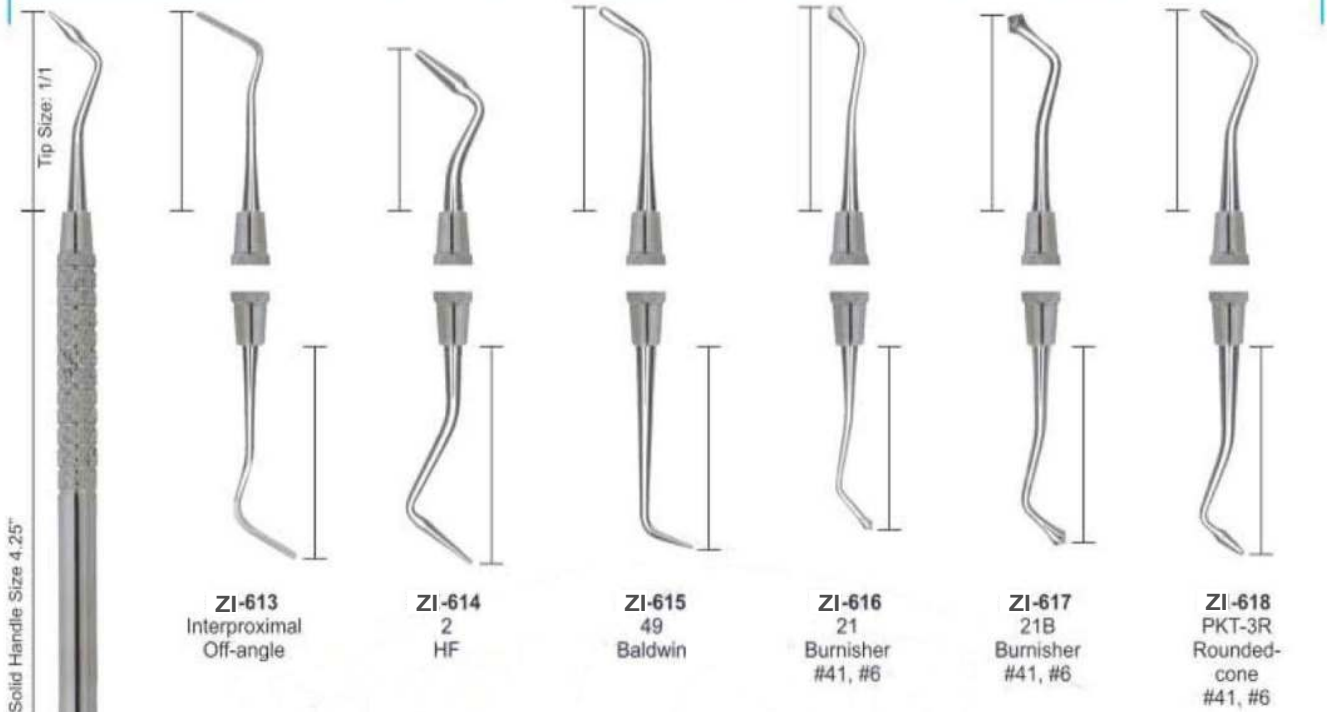

UNIVERSAL FILLING INSTRUMENTS

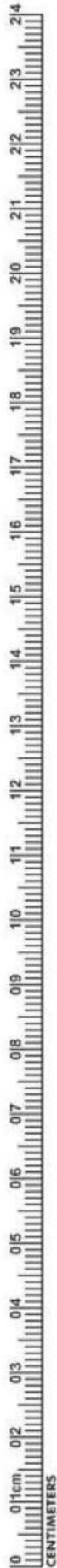
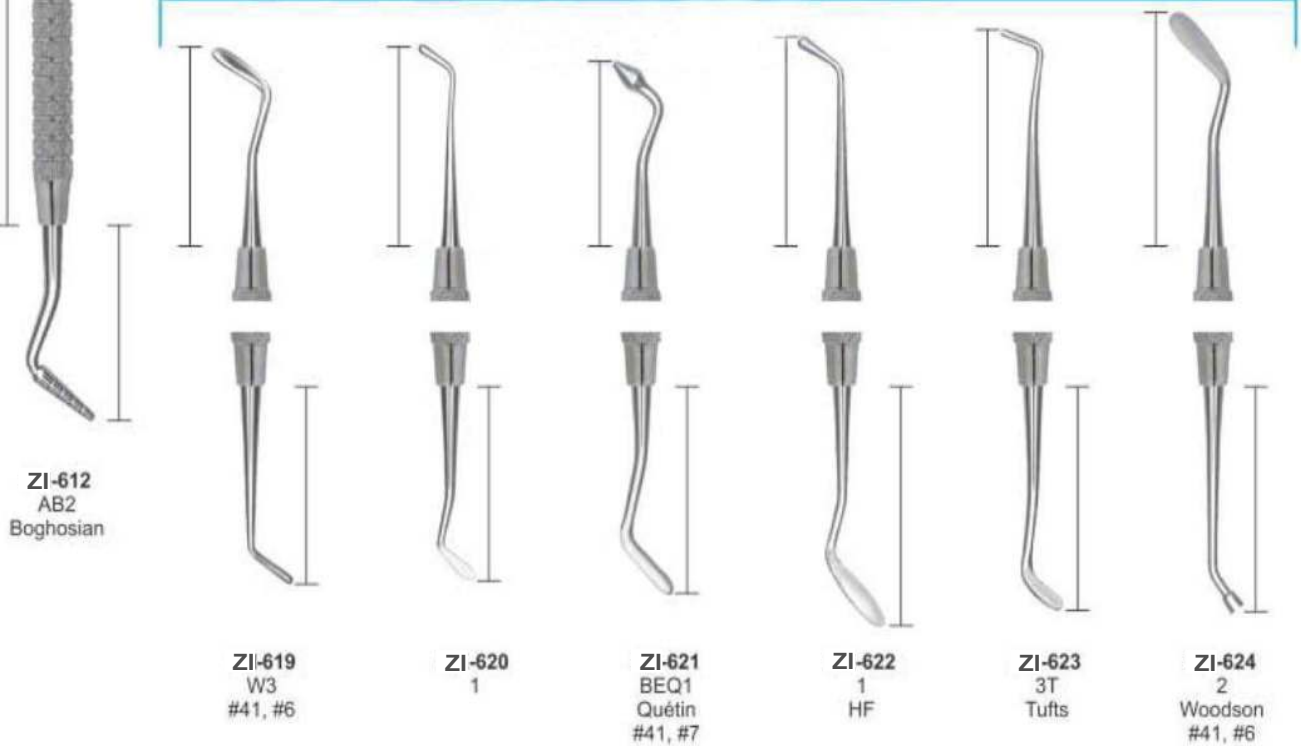

FILLING INSTRUMENTS

- Инструменты для реставрации
- Instruments pour plombage
- Füllungsinstrumente (mit Kontrawinkel)
- Инструменти для реставрації
- Instrumentos para obturaciones
- ملء الصكوك

COMPOSITE/PLASTIC FILLING INSTRUMENTS SOLID HANDLE 6MM, LENGTH 170MM

BLACK

PLUGGERS/CONDENSERS

Hollenback

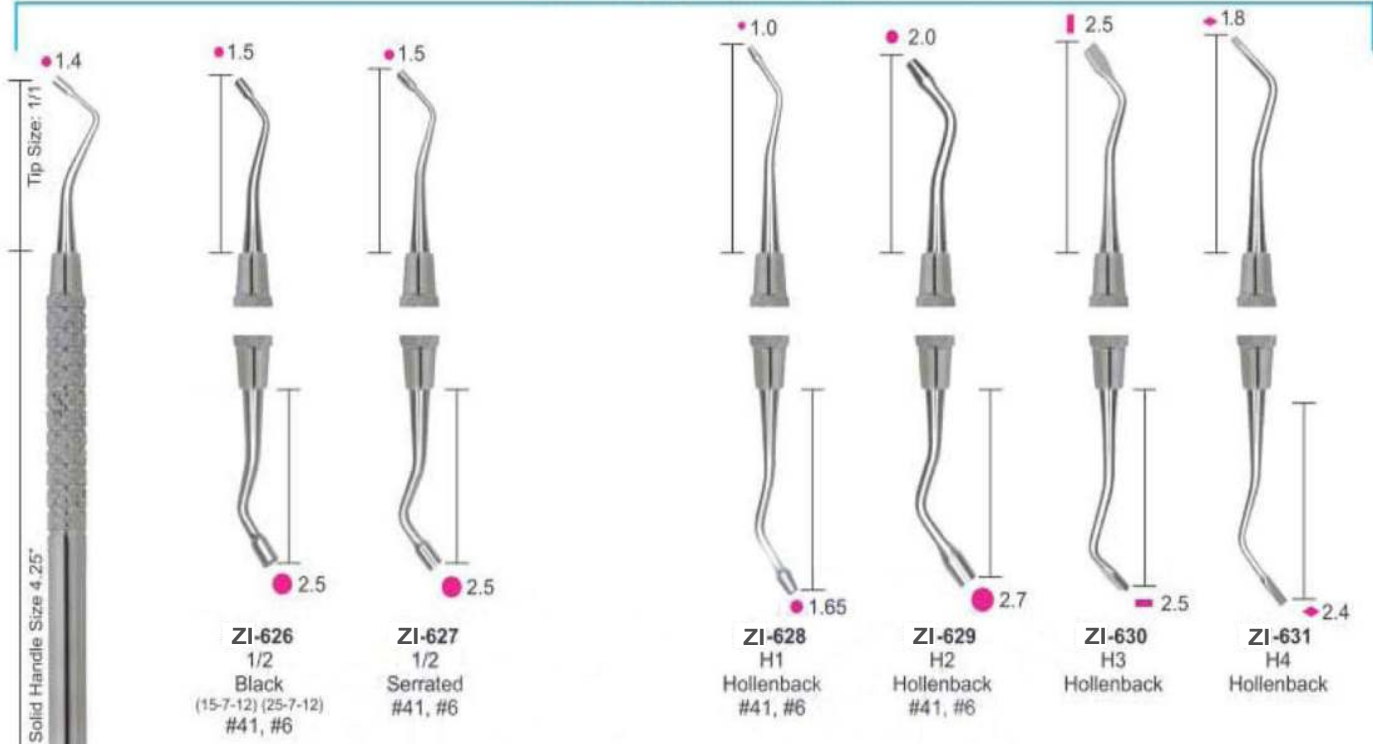

MARQUETTE CONDENSER

MORTONSON

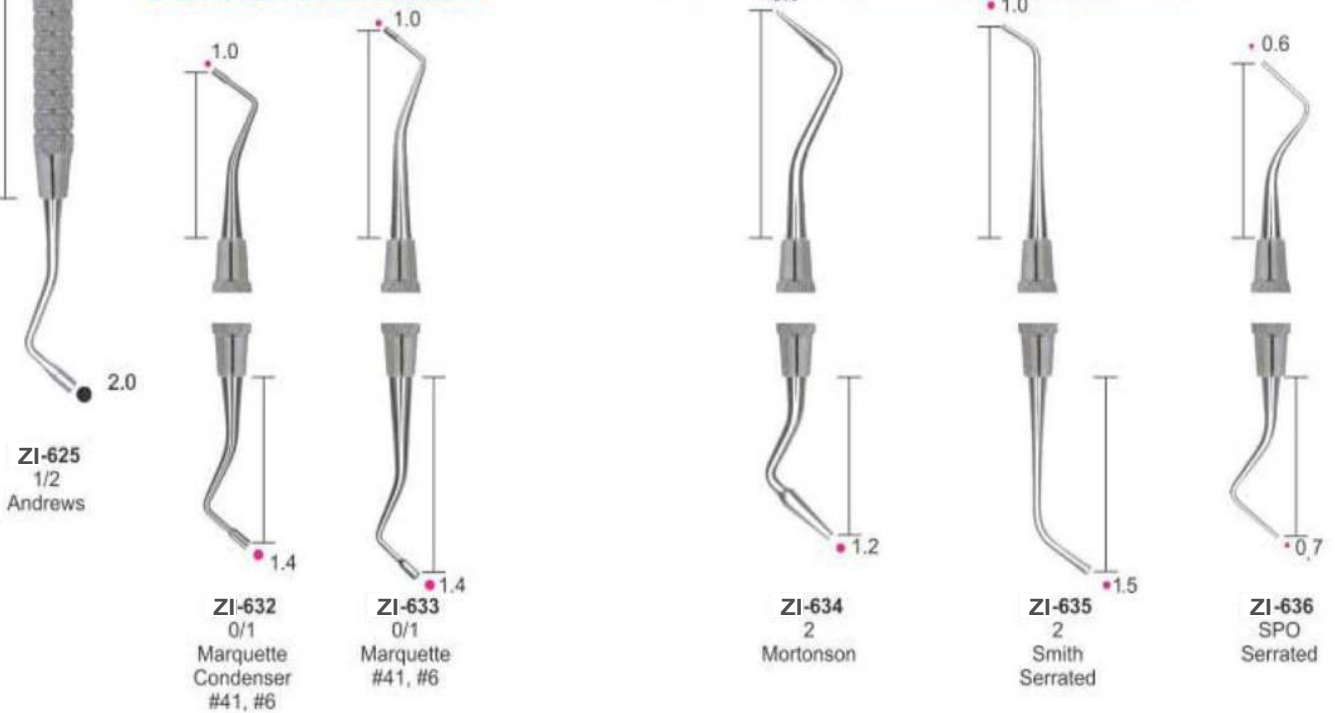

FILLING INSTRUMENTS

- Инструменты для реставрации
- Instruments pour plombage
- Füllungsinstrumente (mit Kontrawinkel)

- Инструменти для реставрації
- Instrumentos para obturaciones
- ملء الصكوك

PLUGGERS/CONDENSERS

RESTORATIVE INSTRUMENTS SOLID HANDLE 6MM, LENGTH 170MM

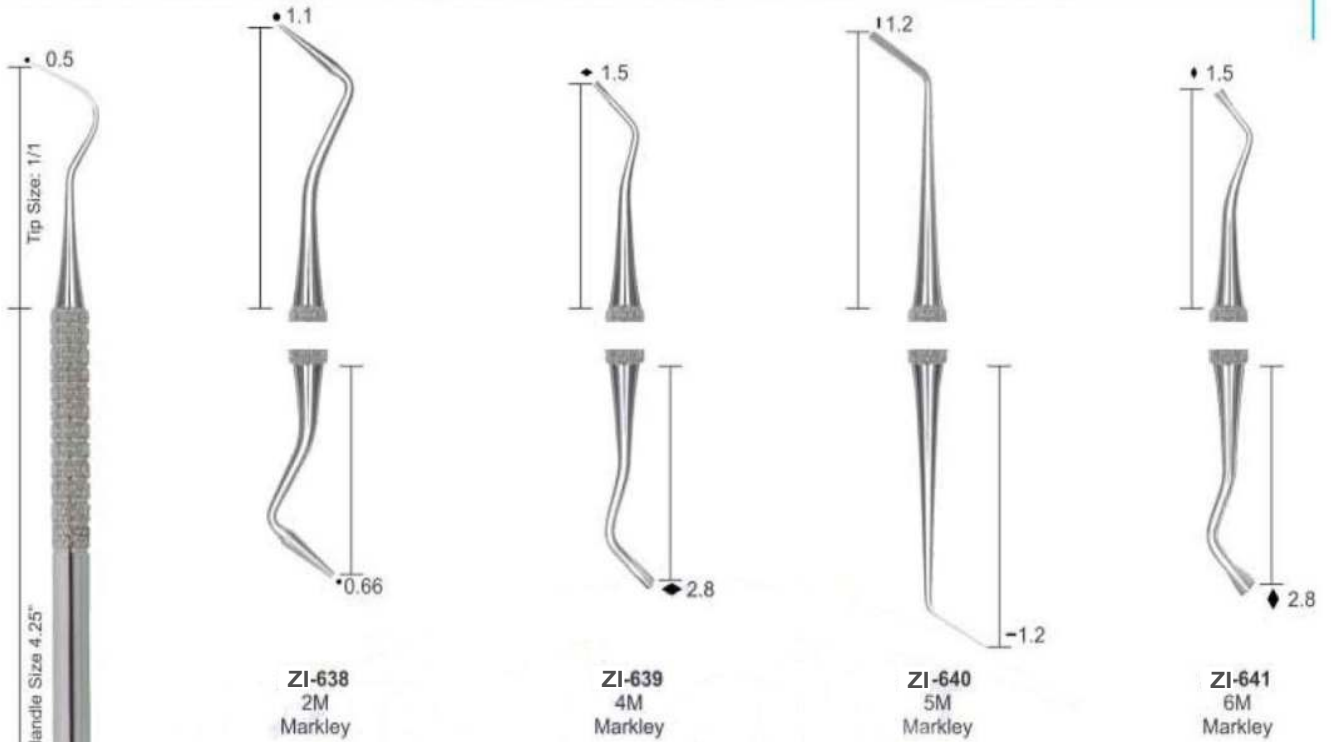

PLUGGERS/CONDENSERS

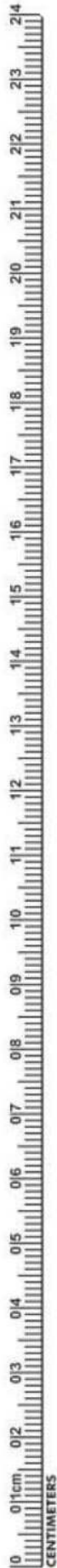
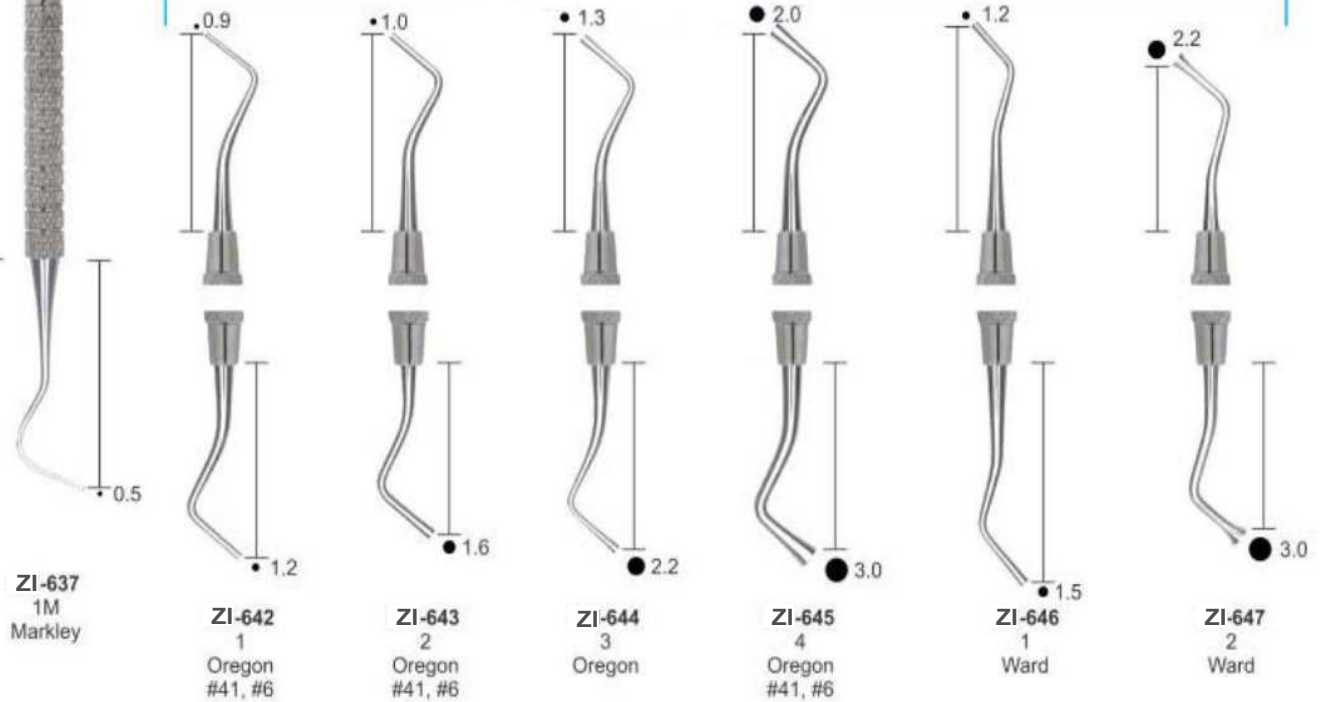

FILLING INSTRUMENTS

- Инструменты для реставрации
- Instruments pour plombage
- Füllungsinstrumente (mit Kontrawinkel)
- Инструменти для реставрації
- Instrumentos para obturaciones
- ملء الصكوك

RESTORATIVE INSTRUMENTS SOLID HANDLE 6MM, LENGTH 170MM

Tanner Filling Instruments

Back Action Filling Instruments

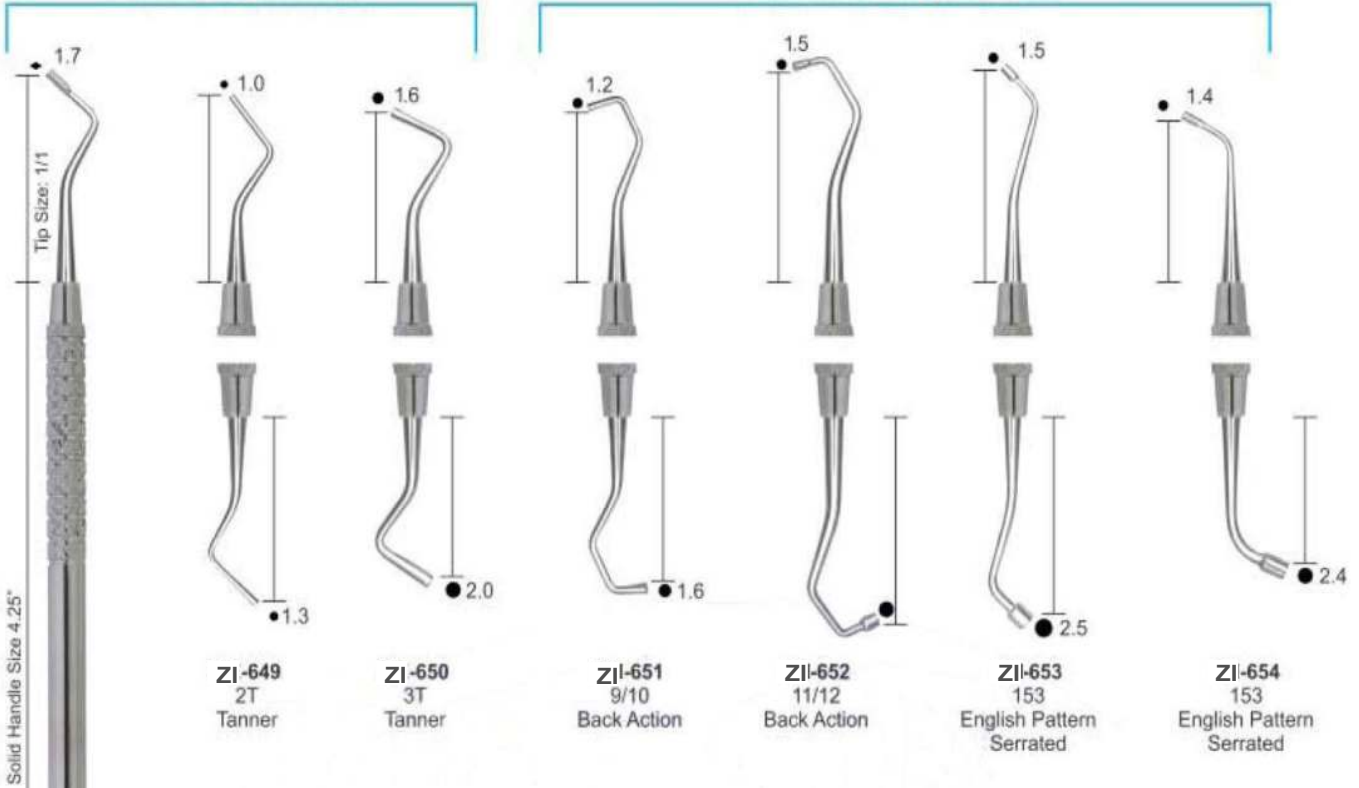

BALL

BURNISHERS

BEAVERTAIL

ACORN

LADMORE

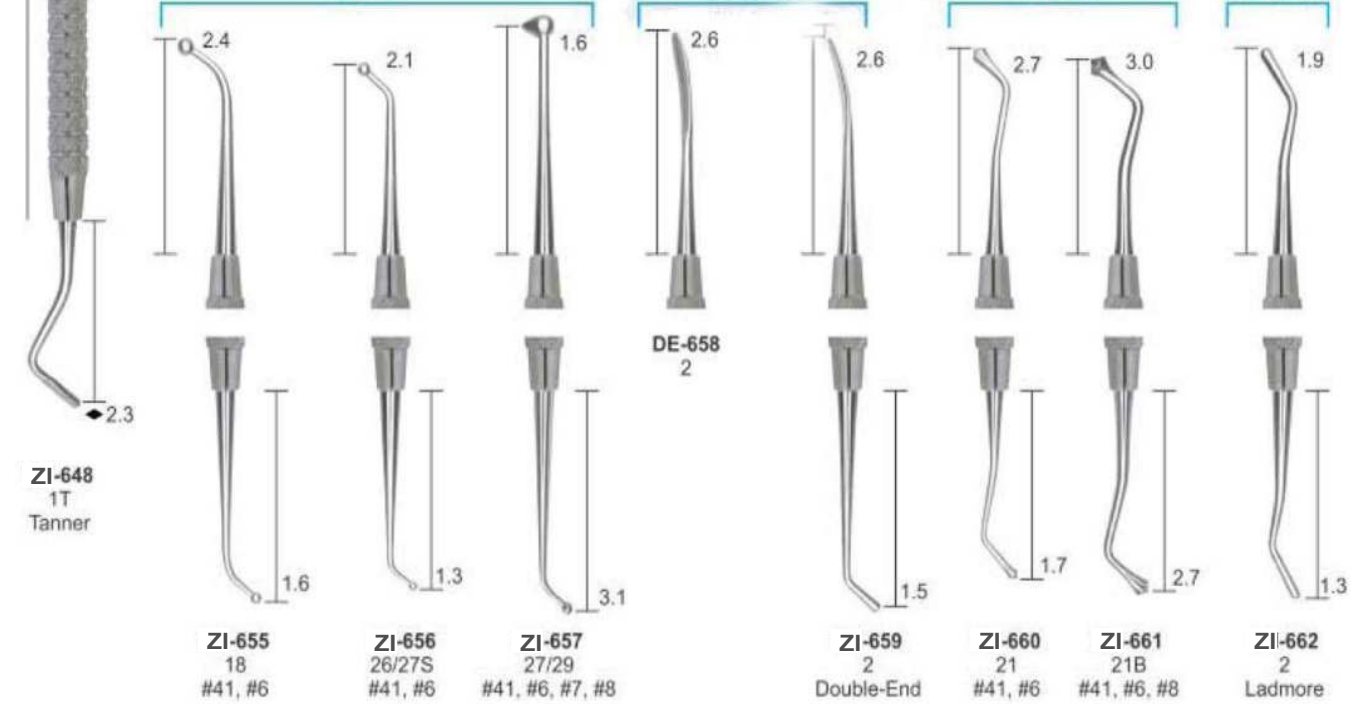

FILLING INSTRUMENTS

- Инструменты для реставрации
- Instruments pour plombage
- Füllungsinstrumente (mit Kontrawinkel)

- Инструменти для реставрації
- Instrumentos para obturaciones
- ملء الصكوك

RESTORATIVE INSTRUMENTS SOLID HANDLE 6MM, LENGTH 170MM

BURNISHERS

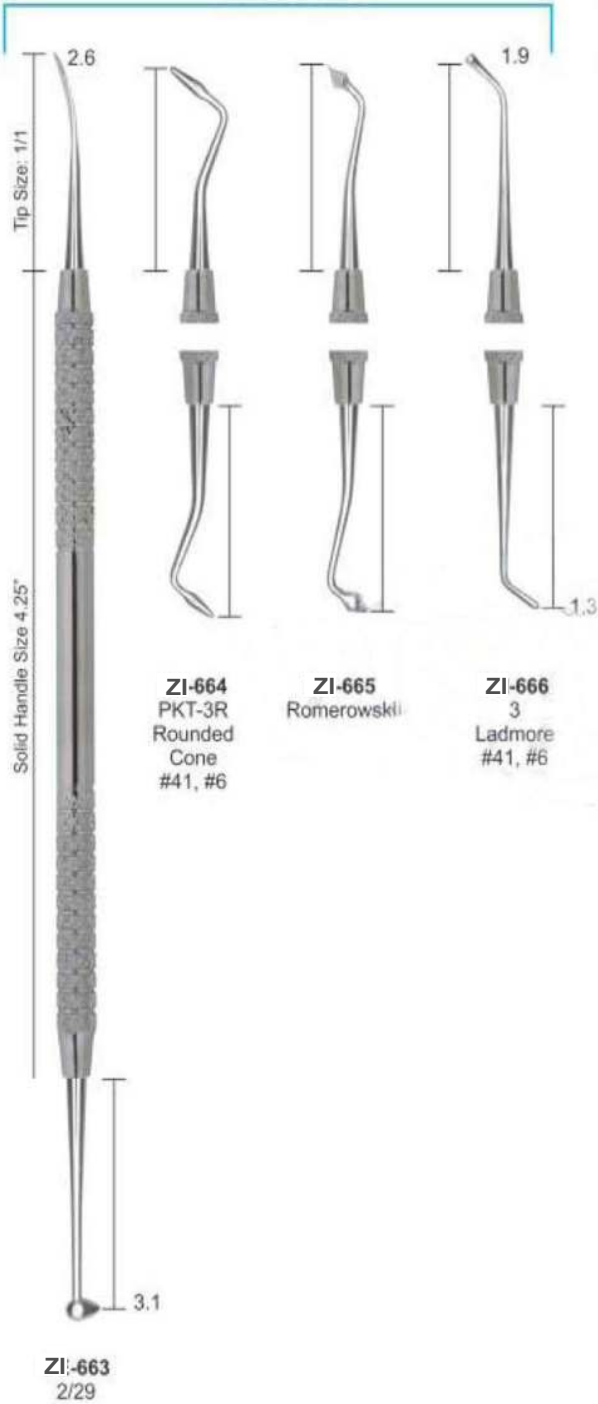

PERIODONTAL FILES

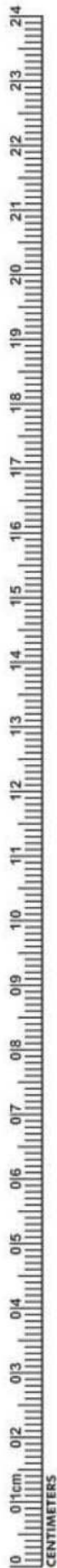

FILLING INSTRUMENTS

- Инструменты для реставрации
- Instruments pour plombage
- Füllungsinstrumente (mit Kontrawinkel)
- Инструменти для реставрації
- Instrumentos para obturaciones
- ملء الصكوك

COMPOSITE/PLASTIC FILLING INSTRUMENTS
SOLID HANDLE 6MM, LENGTH 170MM

BURNISHER FILLING INSTRUMENTS

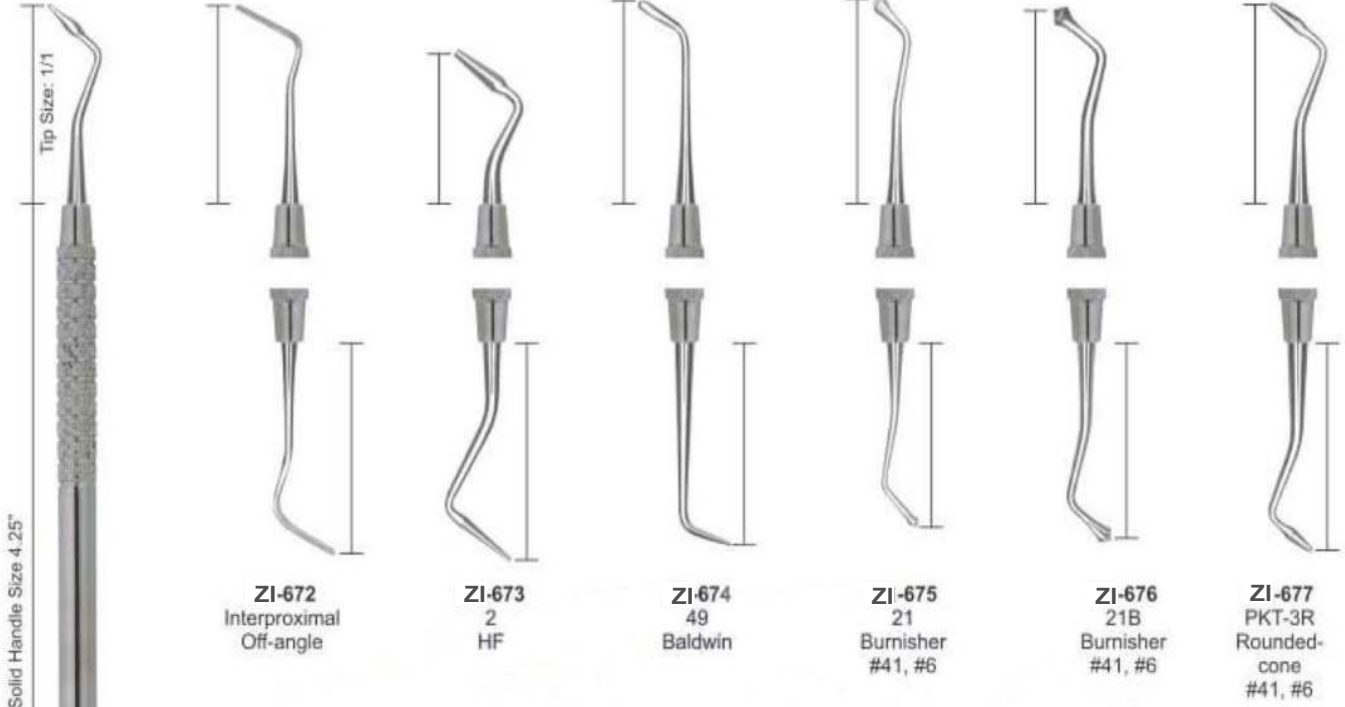

UNIVERSAL FILLING INSTRUMENTS

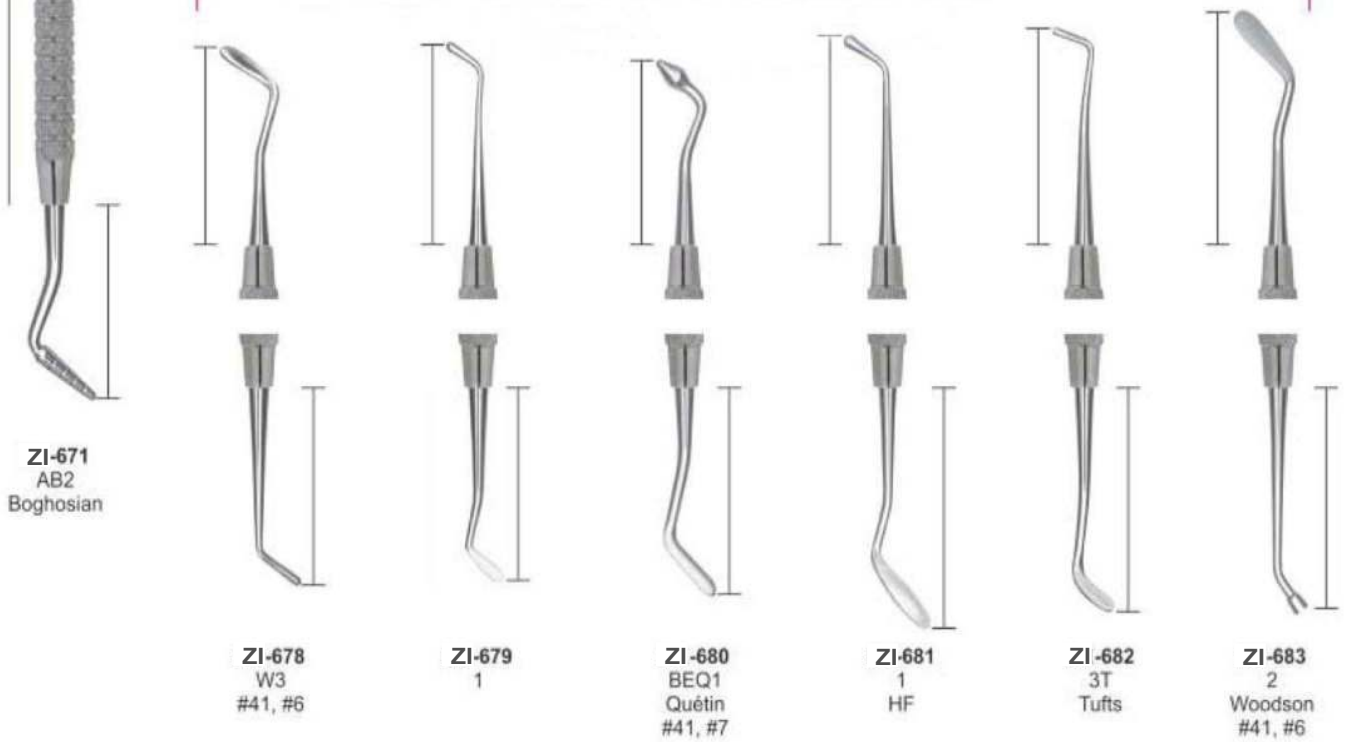

INCHES

FILLING INSTRUMENTS

- Инструменты для реставрации
- Instruments pour plombage
- Füllungsinstrumente (mit Kontrawinkel)

- Інструменти для реставрації
- Instrumentos para obturaciones
- ملء الصنوك

FILLING INSTRUMENTS SOLID HANDLE 6MM, LENGTH 170MM

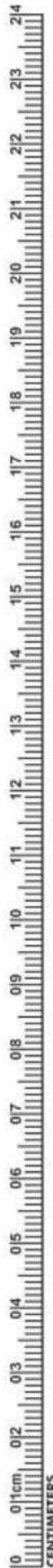

AMALGAM CARVERS

- Инструменты для реставрации
- Instruments pour amalgame
- Amalgampistolen

- Інструменти для реставрації
- instrumentos para amalgama
- تقطیع الملعق

AMALGAM INSTRUMENTS SOLID HANDLE 6MM, LENGTH 170MM

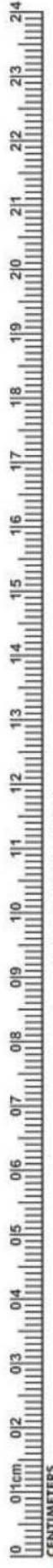

Excavators Instruments Set of 11 Pieces

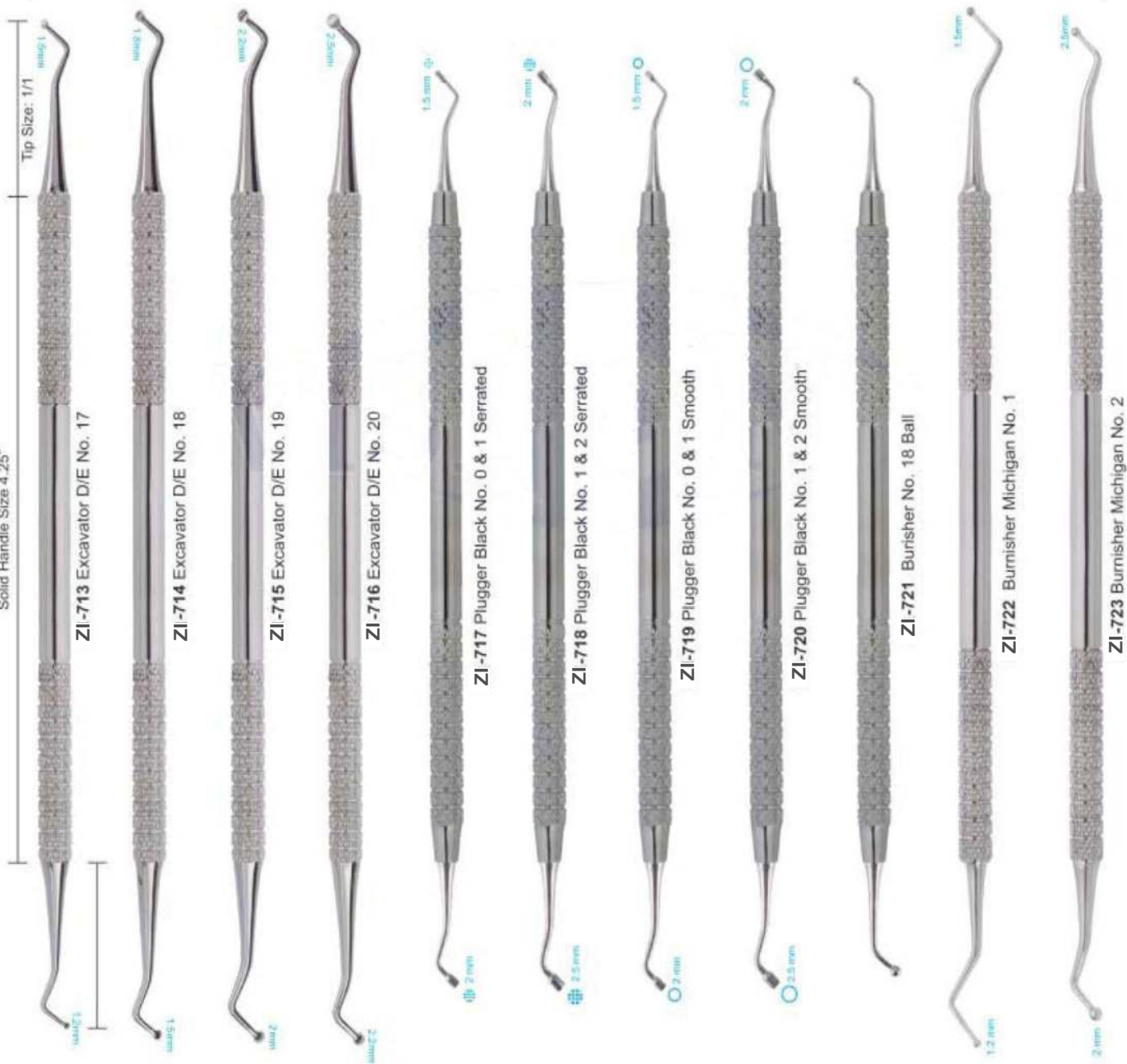

PERIODONTAL INSTRUMENTS

- Инструменты пародонтологические
- Instruments pour la parodontologie
- Instrumente für die Parodontologie
- Інструменти пародонтологічні
- instrumentos para periodoncia
- الصلوك اللثة

SICKLE SCALERS INSTRUMENTS SOLID HANDLE 6MM, LENGTH 170MM

SICKLE SCALERS



- | | | | | | | |
|--|---|---|--|---|---|---|
| <p>ZI-724
H6/H7†
Hygienist
#2, #4, #6,
#7, #8, #9</p> | <p>ZI-725
6/7
Goldman
#2, #4, #6,
#7, #8</p> | <p>ZI-726
U15
Towner
#24, #6,
#7, #8</p> | <p>ZI-727
H5/U15
Hygienist-
Towner
#2, #4, #6</p> | <p>ZI-728
U15/30
Towner-
Jacquette
#2, #4, #6
#7, #8, #9</p> | <p>ZI-729
H15/33†
Hygienist-
Jacquette
#2, #4, #6
#7, #8, #9</p> | <p>ZI-730
U15/33
Towner-
Jacquette
#2, #4, #6
#7, #8, #9</p> |
|--|---|---|--|---|---|---|



PERIODONTAL INSTRUMENTS

- Инструменты пародонтологические
- Instruments pour la parodontologie
- Instrumente für die Parodontologie

- Інструменти пародонтологічні
- instrumentos para periodoncia
- الصكوك اللثة

PERIODONTAL INSTRUMENTS SOLID HANDLE 6MM, LENGTH 170MM

JACQUETTE SCALERS

CRANE-KAPLAN

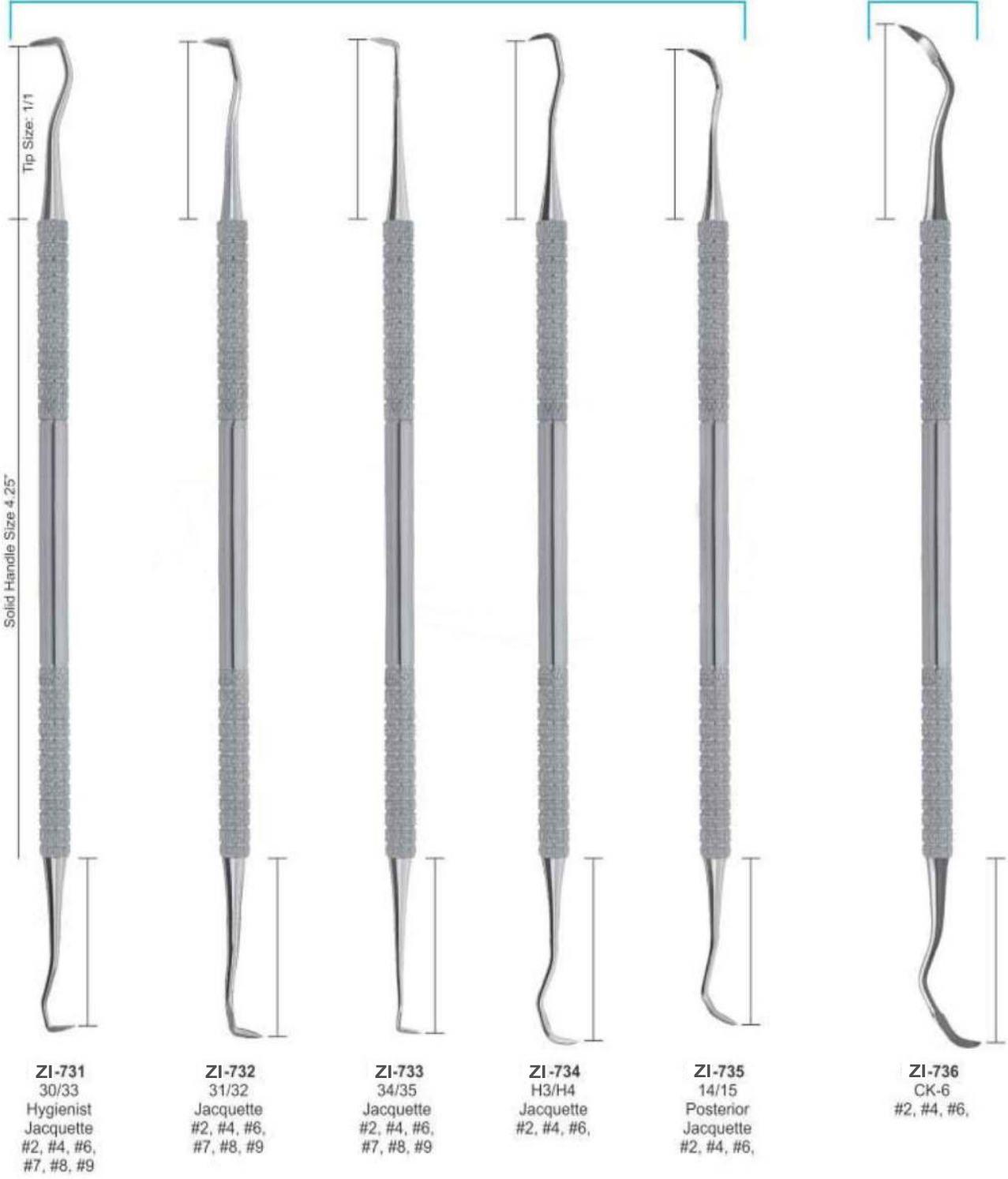
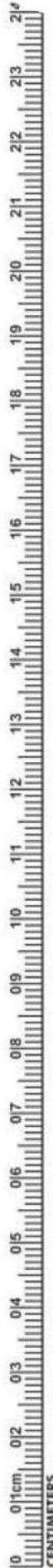

ZI-731
30/33
Hygienist
Jacquette
#2, #4, #6,
#7, #8, #9

ZI-732
31/32
Jacquette
#2, #4, #6,
#7, #8, #9

ZI-733
34/35
Jacquette
#2, #4, #6,
#7, #8, #9

ZI-734
H3/H4
Jacquette
#2, #4, #6,

ZI-735
14/15
Posterior
Jacquette
#2, #4, #6,

ZI-736
CK-6
#2, #4, #6,

PERIODONTAL INSTRUMENTS

- Инструменты пародонтологические
- Instruments pour la parodontologie
- Instrumente für die Parodontologie
- Инструменти пародонтологічні
- instrumentos para periodoncia
- المسكوك اللثة

PERIODONTAL INSTRUMENTS SOLID HANDLE 6MM, LENGTH 170MM SCALER/CURETTE SETS

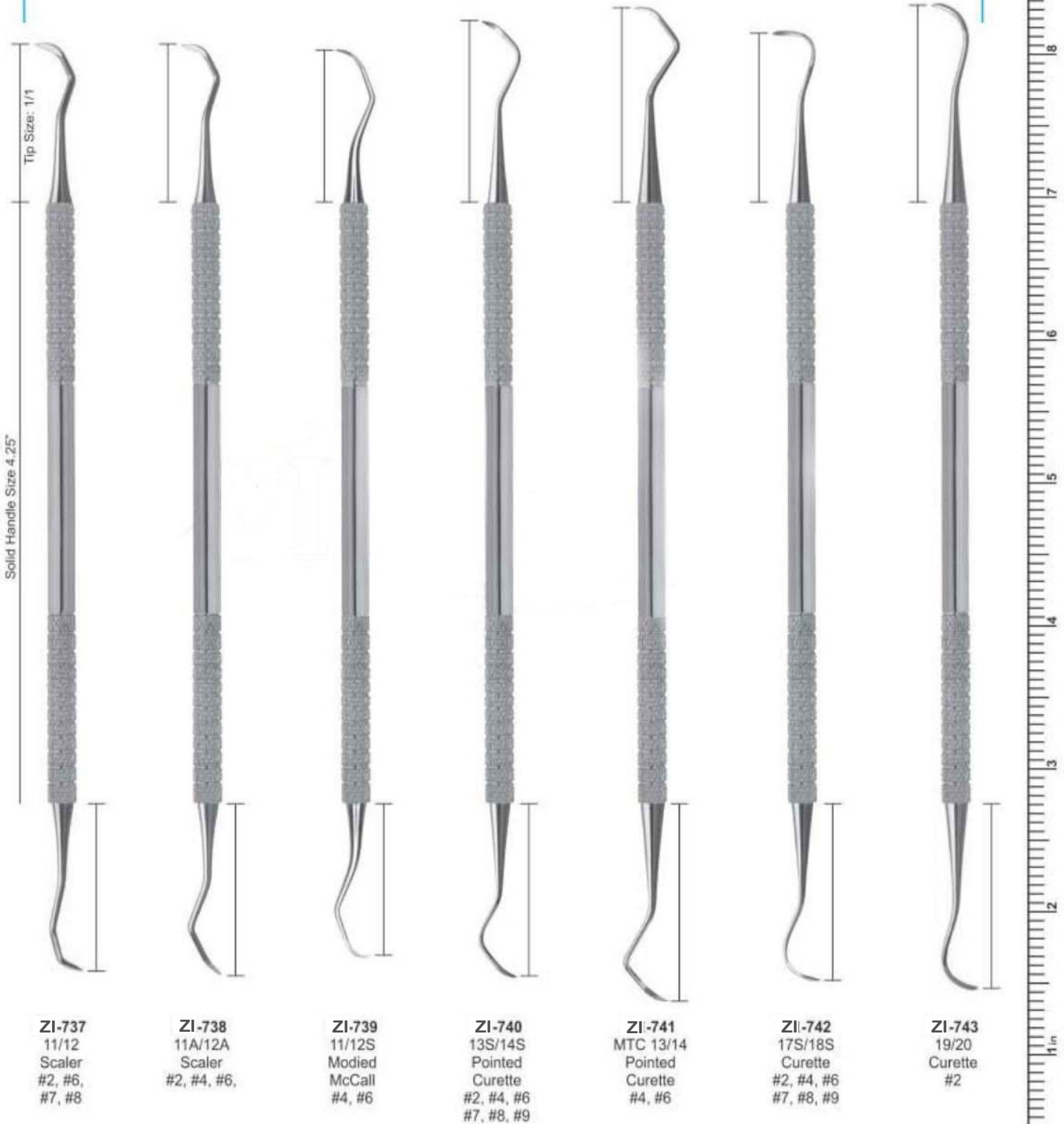

CURETTES

- Кюрети
- Curetas
- Küretten
- Кюрети
- Curette
- کرتس

SCALER/CURETTE SETS

GOLDMAN-FOX SET

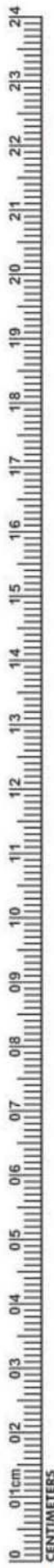

- | | | | | | | | | | |
|---|---|---|--|--|---|---|---|--|--|
| <p>ZI-744
103/106
#4, #6</p> | <p>ZI-744A
104/105
Hoe/Chisel
#4, #6</p> | <p>ZII-745
107/108
#2, #4, #6
#7, #8</p> | <p>ZI-746
107/108S
Modifed
#2, #4</p> | <p>ZI-747
1/2
(shown)
#2, #4, #6
#7, #8, #9</p> | <p>ZI-749
3/4†
(shown)
#2, #4, #6
#7, #8, #9</p> | <p>ZI-751
5/6†
(shown)
#2, #4, #6
#7, #8, #9</p> | <p>ZI-754
7/8†
(shown)
#2, #4, #6
#7, #8, #9</p> | | |
| | | | | <p>ZI-748
1/2
Rigid
#2, #4, #6
#7, #8, #9</p> | <p>ZI-750
3/4
Rigid
#2, #4, #6
#7, #8, #9</p> | <p>ZI-752
5/6
Rigid
#2, #4, #6
#7, #8, #9</p> | <p>ZI-753
5/6
Extra Rigid
#4, #6 #7,
#8</p> | <p>ZI-755
7/8
Rigid
#2, #4, #6
#7, #8, #9</p> | <p>ZI-756
7/8
Extra Rigid
#2, #4, #6
#7, #8, #9</p> |

**SCALER/CURETTE SETS INSTRUMENTS
SOLID HANDLE 6MM, LENGTH 170MM**

CURETTES

- Кюрети
- Curetas
- Küretten
- Кюрети
- Curette
- كرتس

GRACEY CURETTE INSTRUMENTS SOLID HANDLE 6MM, LENGTH 170MM

GRACEY CURETTES

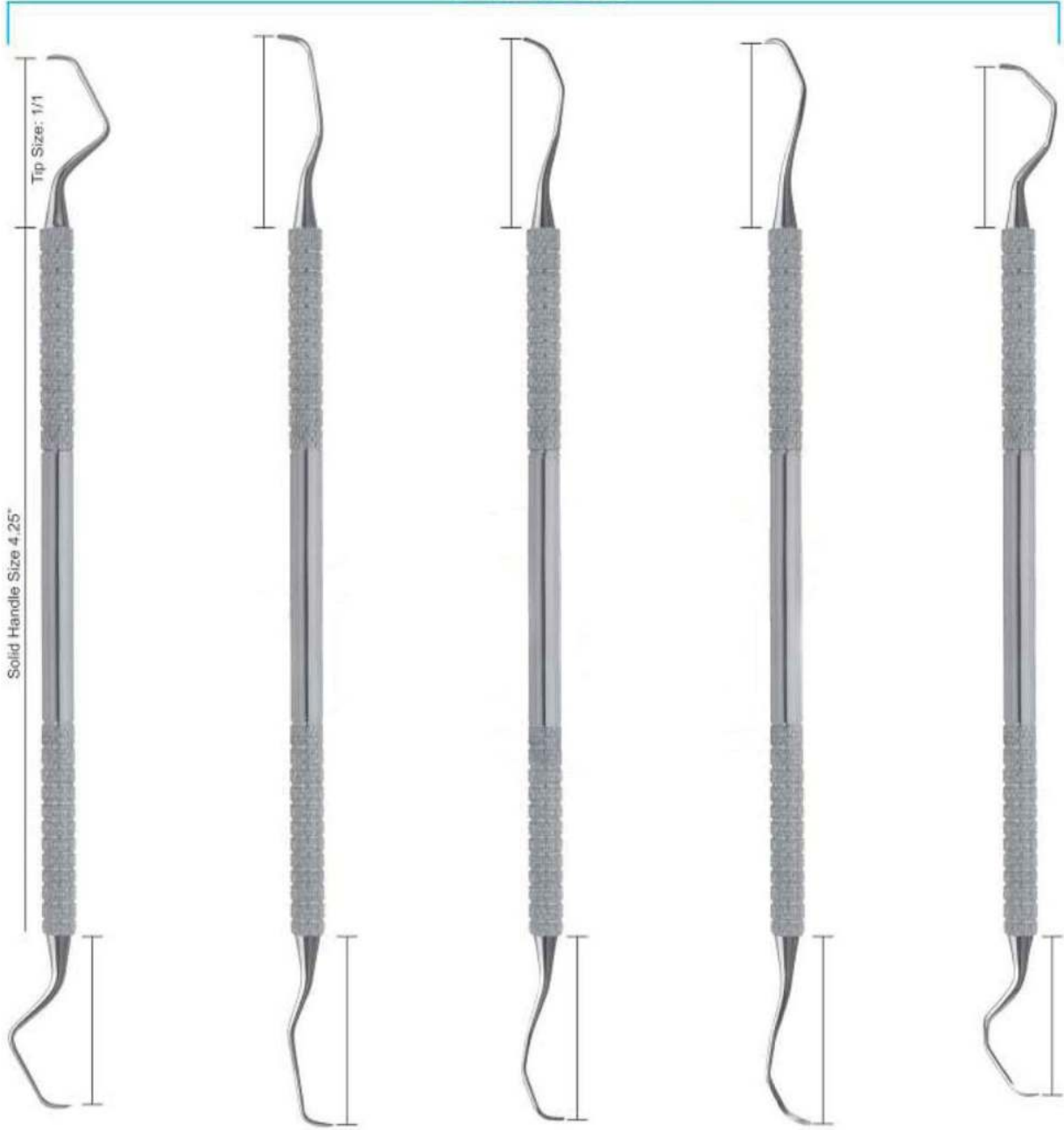

ZI-757
9/10†
(shown)
#2, #4, #6
#7, #8, #9

ZI-759
11/12†
(shown)
#2, #4, #6
#7, #8, #9

ZI-792
13/14†
(shown)
#2, #4, #6
#7, #8, #9

ZI-765
15/16†
(shown)
#2, #4, #6
#7, #8, #9

ZI-767
17/18
#2, #4, #6
#7, #8, #9

ZI-758
9/10
Rigid
#2, #4, #6
#7, #8

ZI-760 **ZI-761**
11/12 11/12
Rigid Extra Rigid
#2, #4, #6 #4, #6 #7,
#7, #8, #9 #8

ZI-793 **BSI-764**
13/14 13/14
Rigid Extra Rigid
#2, #4, #6 #4, #6 #7,
#7, #8, #9 #8

ZI-766
15/16
Rigid
#2, #4, #6
#7, #8, #9

ZI-768
17/18
Rigid
#2, #4, #6
#7, #8, #9



CURETTES

- Кюрети
 - Curetas
 - Küretten
- Кюрети
 - Curette
 - کرتس

CURETTE INSTRUMENTS HOLLOW HANDLE 8.5MM, LENGTH 170MM



ZI-769
Hemingway
2mm, 2mm

ZI-770
Hemingway
3mm, 3mm

ZI-771
Hemingway
4mm, 4mm

CURETTE INSTRUMENTS SOLID HANDLE 6MM, LENGTH 170MM



ZI-772
Hemingway
2mm, 2mm

ZI-773
Hemingway
3mm, 3mm

ZI-774
Hemingway
4mm, 4mm

CURETTE INSTRUMENTS SOLID HANDLE 6MM, LENGTH 170MM



ZI-775
Hemingway
2mm, 2mm

ZI-776
Hemingway
3mm, 3mm

ZI-777
Hemingway
4mm, 4mm

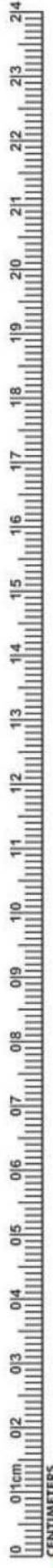

EXCAVATORS

- Экскаваторы
- Excavateurs
- Excavatoren
- عسكافطوري
- Excavadores
- حفارات

EXCAVATORS INSTRUMENTS SOLID HANDLE 6MM, LENGTH 170MM SPOONS

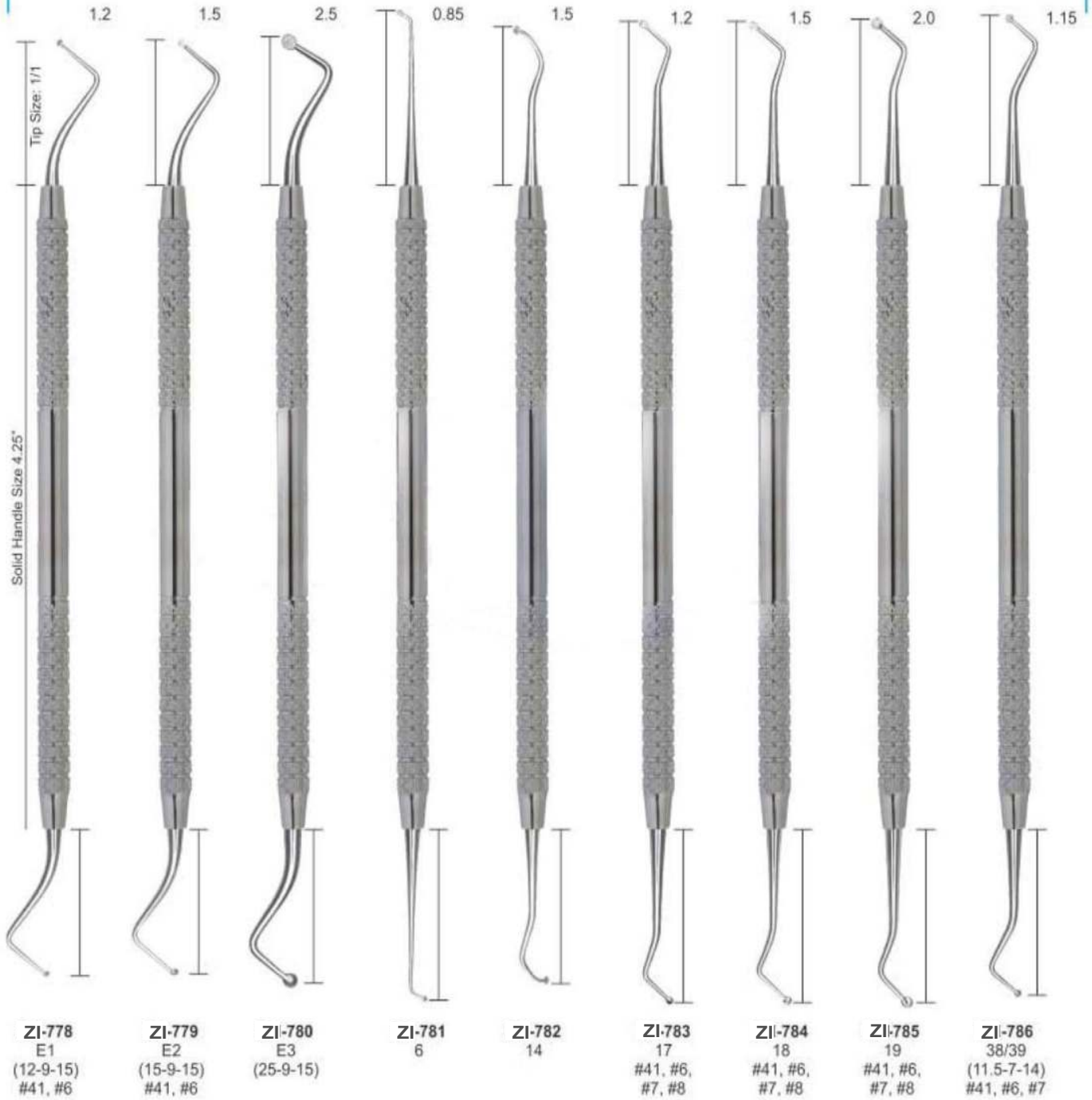

EXCAVATORS

- Экскаваторы
- Excavateurs
- Excavatoren

- Бкскаватори
- Excavadores
- حفارات

OVAL SPOONS/DARBY-PERRY

EXCAVATORS INSTRUMENTS SOLID HANDLE 6MM, LENGTH 170MM

EXCAVATORS

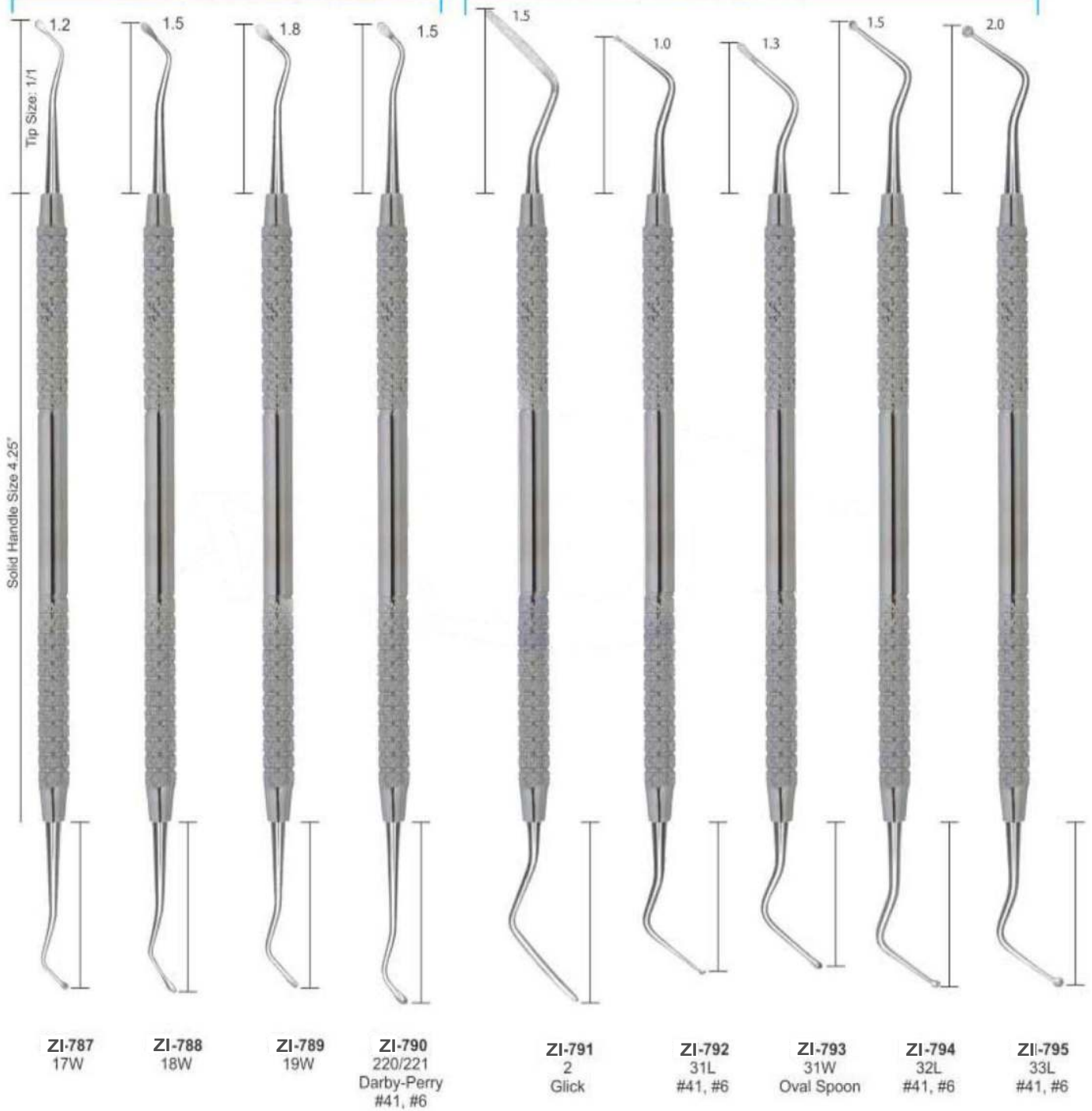

10 011cm, 012 013 014 015 016 017 018 019 020 021 022 023 024
CENTIMETERS

EXCAVATORS

- Экскаваторы
- Excavateurs
- Excavatoren
- Excavatori
- Excavadores
- حفارات

EXCAVATORS INSTRUMENTS SOLID HANDLE 6MM, LENGTH 170MM

BLADES

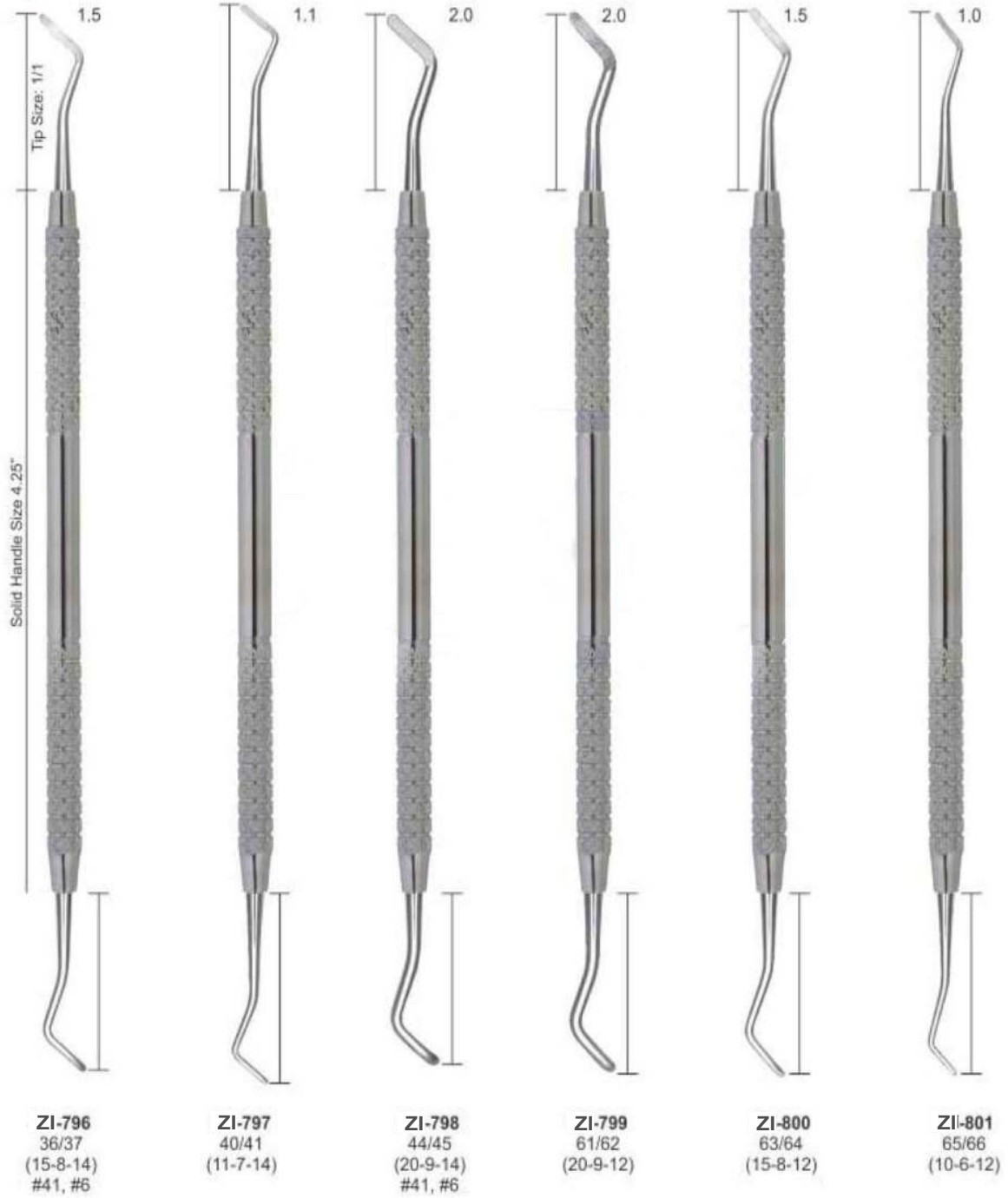

EXCAVATORS

- Экскаваторы
- Excavateurs
- Excavatoren
- Бкскаватори
- Excavadores
- حفارات

EXCAVATORS INSTRUMENTS SOLID HANDLE 6MM, LENGTH 170MM

ENGLISH PATTERNS

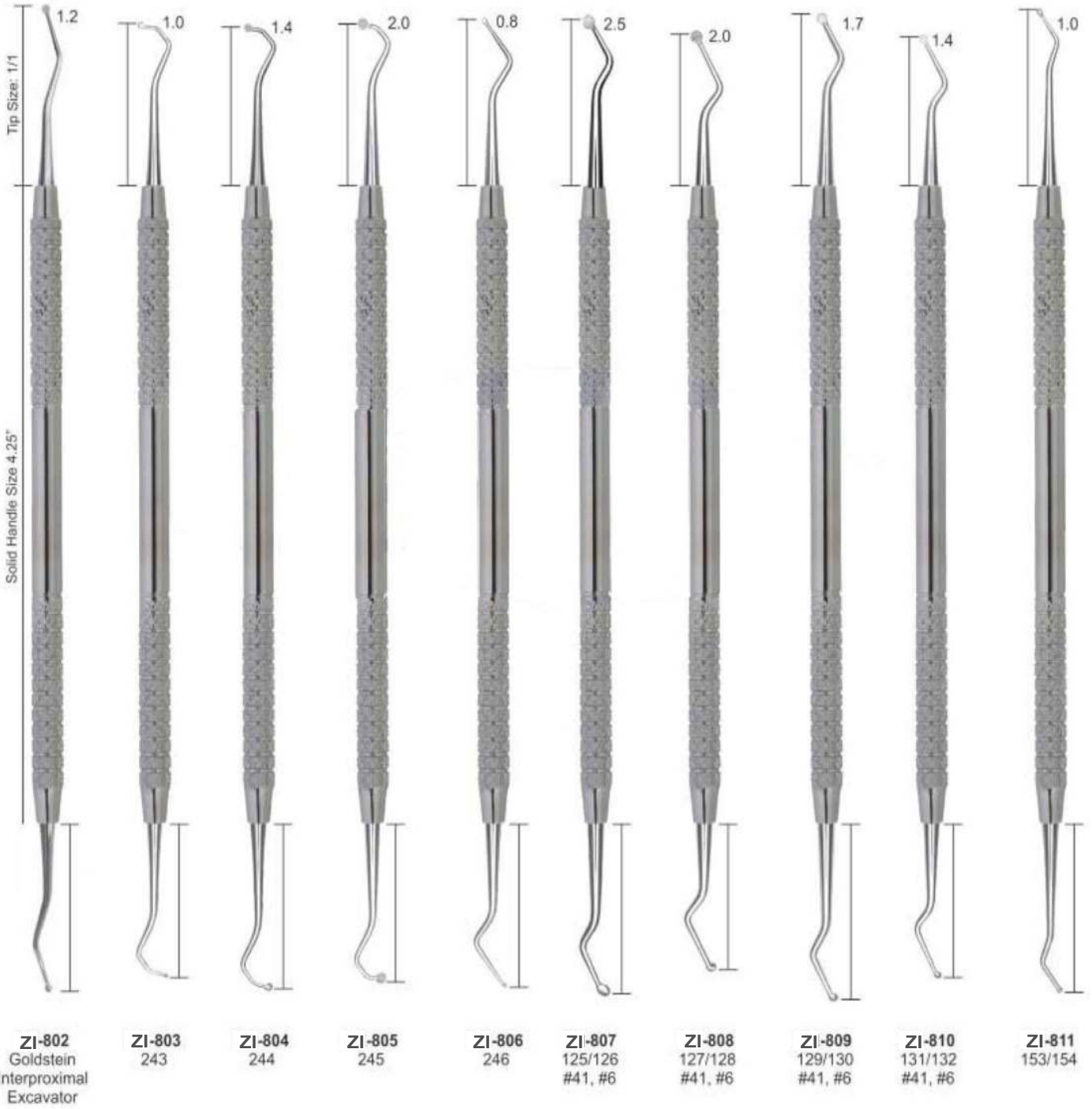
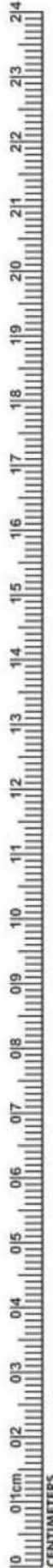

ZI-802
Goldstein
Interproximal
Excavator

ZI-803
243

ZI-804
244

ZI-805
245

ZI-806
246

ZI-807
125/126
#41, #6

ZI-808
127/128
#41, #6

ZI-809
129/130
#41, #6

ZI-810
131/132
#41, #6

ZI-811
153/154

FILLING INSTRUMENTS

- Инструменты для реставрации
- Instruments pour plombage
- Füllungsinstrumente (mit Kontrawinkel)
- Инструменти для реставрації
- Instrumentos para obturaciones
- ملء الصكوك

HATCHETS

RESTORATIVE INSTRUMENTS SOLID HANDLE 6MM, LENGTH 170MM

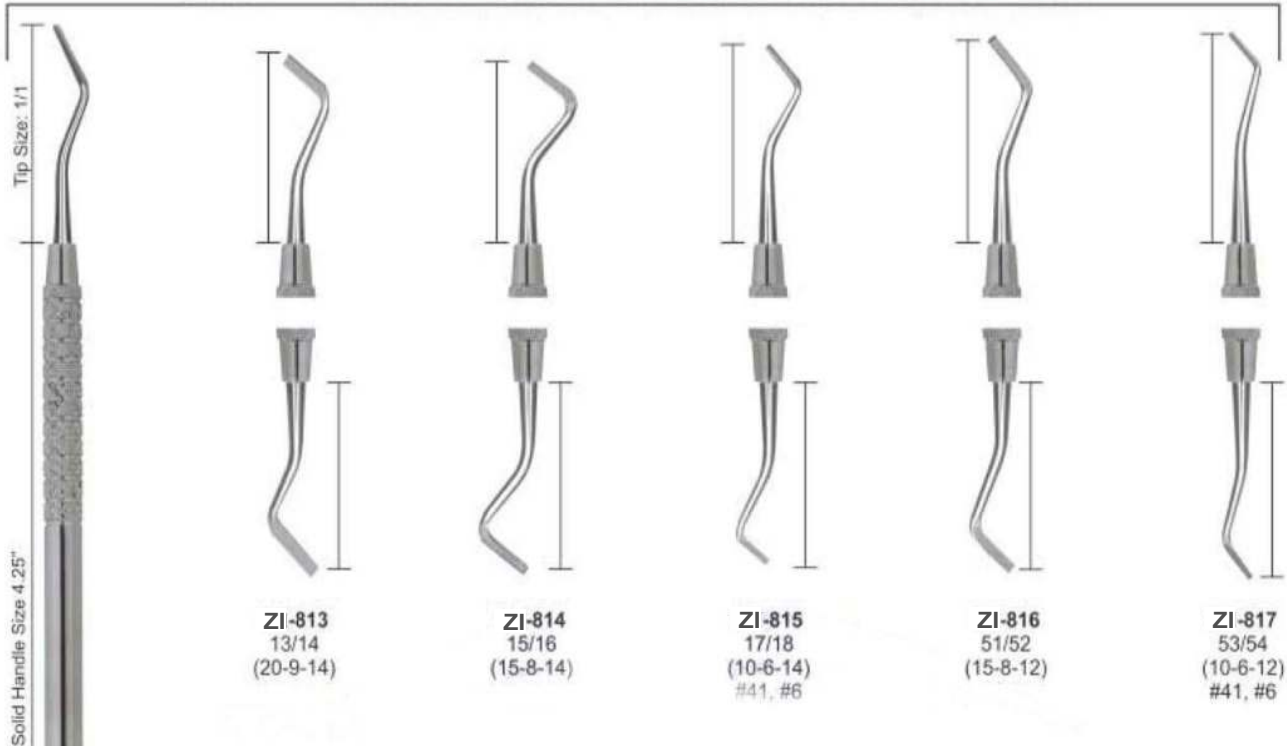

ANTERIOR



INCHES

FILLING INSTRUMENTS

- Инструменты для реставрации
- Instruments pour plombage
- Füllungsinstrumente (mit Kontrawinkel)
- Инструменти для реставрації
- Instrumentos para obturaciones
- ملء المسكوك

CARVERS

RESTORATIVE INSTRUMENTS SOLID HANDLE 6MM, LENGTH 170MM

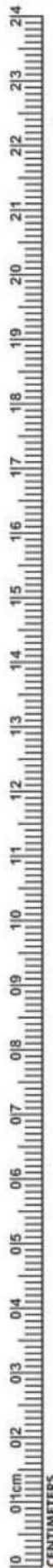

Tip Size: 1/1

Solid Handle Size 4.25"

ZI-826
Inter-proximal
#41, #6, #7

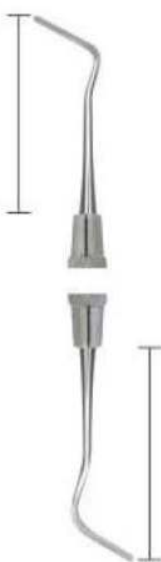

ZI-827
Inter-proximal
Off-Angle



ZI-828
1/2-3
Hollenback
#41, #6,
#7, #8



ZI-829
3S
Hollenback
#41, #6, #7



ZI-830
3
Hollenback



ZI-831
8
Wiland
Minn.IPC1
#41, #6, #7

TANNER

WALL

WARD



ZI-832
3
Tanner



ZI-833
4
Tanner



ZI-834
5
Tanner



ZI-835
6
Tanner



ZI-836
1
Wall



ZI-837
3
Wall



ZI-838
1
Ward



ZI-839
2
Ward

AMALGAM CARVERS

- Инструменты для реставрации
- Instruments pour amalgame
- Amalgampistolen
- Инструменти для реставрації
- instrumentos para amalgama
- تقطیع الملقم

RESTORATIVE INSTRUMENTS

ANDREW SOLID HANDLE 6MM, LENGTH 170MM CLAPPISON/FRAHAM

HOLLENBACK

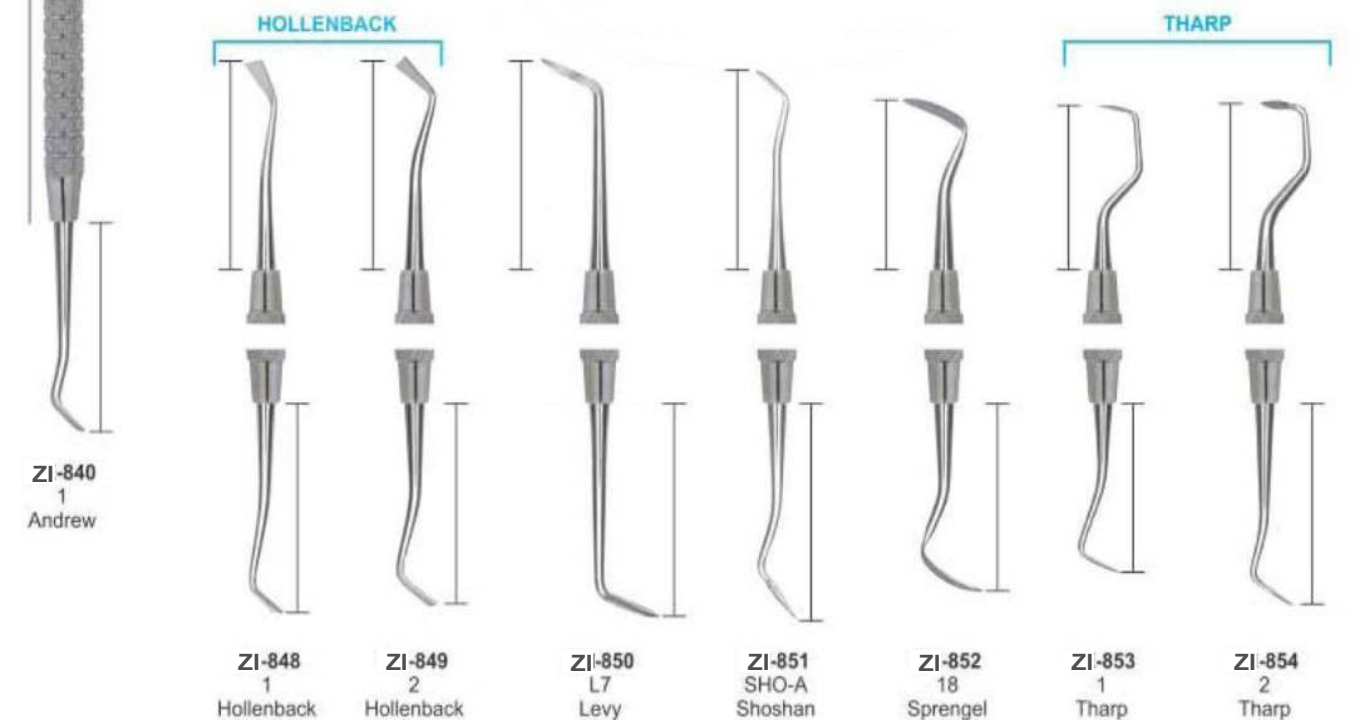
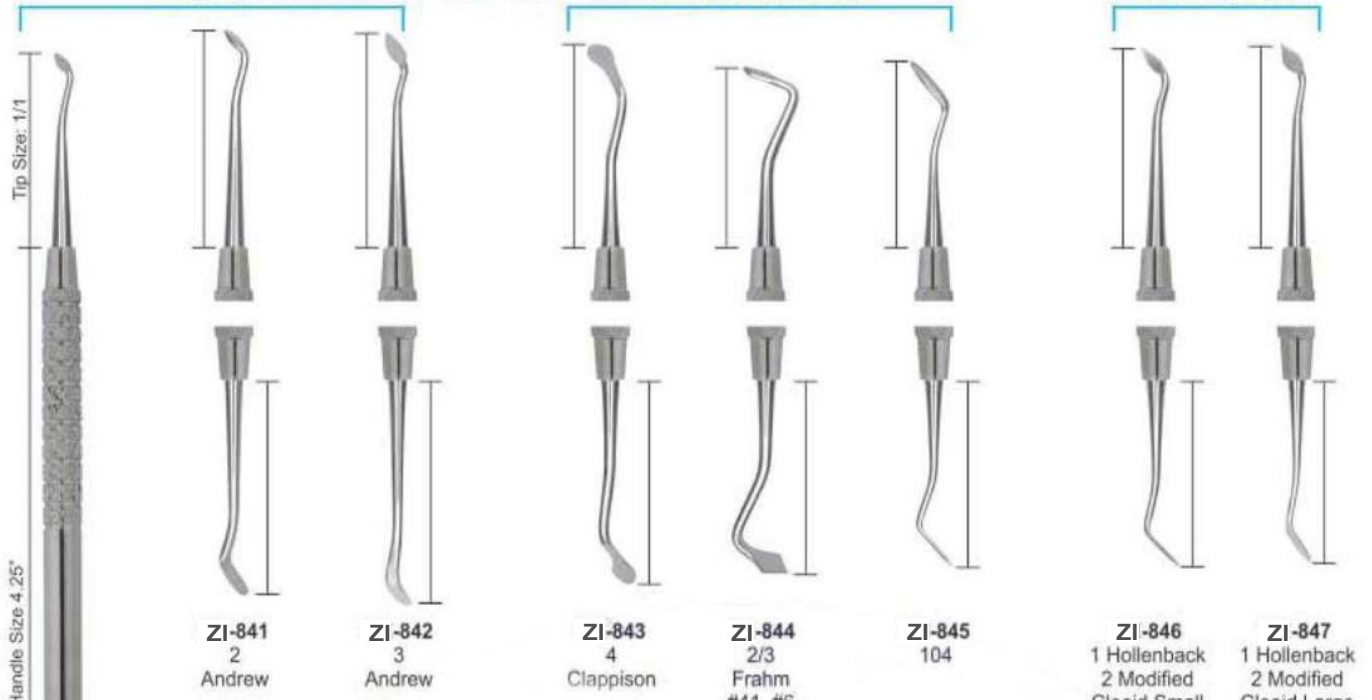

INCHES

AMALGAM CARVERS

- Инструменты для реставрации
- Instruments pour amalgame
- Amalgampistolen

- Інструменти для реставрації
- instrumentos para amalgama
- تقطیع الملقم

RESTORATIVE INSTRUMENTS SOLID HANDLE 6MM, LENGTH 170MM

CARVERS

AMALGAM FILES

HOES

Forming Line Angles on Anterior Preparations.



ZI-856
Discoid-Cleoid Carver



ZI-857
31/32 Rhein



ZI-858
1/4 Wedelstaedt

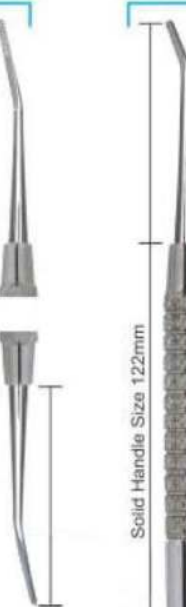

ZI-859
2/5 Wedelstaedt



ZI-863
20 (14-6-8)



ZI-864
21 (10-4-8)



ZI-865
22 (10-4-14)



ZI-866
23 (6.5-2.5-9)

DISCOID-CLEOIDS

DISCOID-CLEOIDS



ZI-860
1/2



ZI-861
4/5 #41, #6, #7



ZI-862
3/6 #41, #6, #7



ZI-867
89/92 #41, #6, #7



ZI-868
90B



ZI-869
W-A-C-D

ZI-855
Anatomical Carver

FILLING INSTRUMENTS

- Инструменты для реставрации
- Instruments pour plombage
- Füllungsinstrumente (mit Kontrawinkel)
- Инструменти для реставрації
- Instrumentos para obturaciones
- ملء الصكوك

RESTORATIVE INSTRUMENTS
SOLID HANDLE 6MM, LENGTH 170MM

MARGIN TRIMMERS



ZI-870
26
(13-95-8-14)
Distal



ZI-871
27
(13-80-8-14)
Mesial



ZI-872
28
(10-95-7-14)
Distal
#41, #6



ZI-873
29
(10-80-7-14)
Mesial
#41, #6



ZI-874
77/78
(15-95-8-12)
Distal



ZI-875
79/80
(15-80-8-12)
Mesial

ANGLE FORMERS



ZI-876
30/31
(12-80-5-8)



ZI-877
32/33
(9-80-4-8)



ZI-878
34/35
(7-80-2.5-9)



CARVERS INSTRUMENTS

- Инструменты для реставрации
- Instruments a modeler
- Modellerinstrumente

- Инструменти для реставрації
- Instrumentos para modelar
- أدوات تنطبع

P.K. THOMS WAXING INSTRUMENTS SOLID HANDLE 6MM, LENGTH 170MM

P.K. THOMAS WAXING INSTRUMENTS

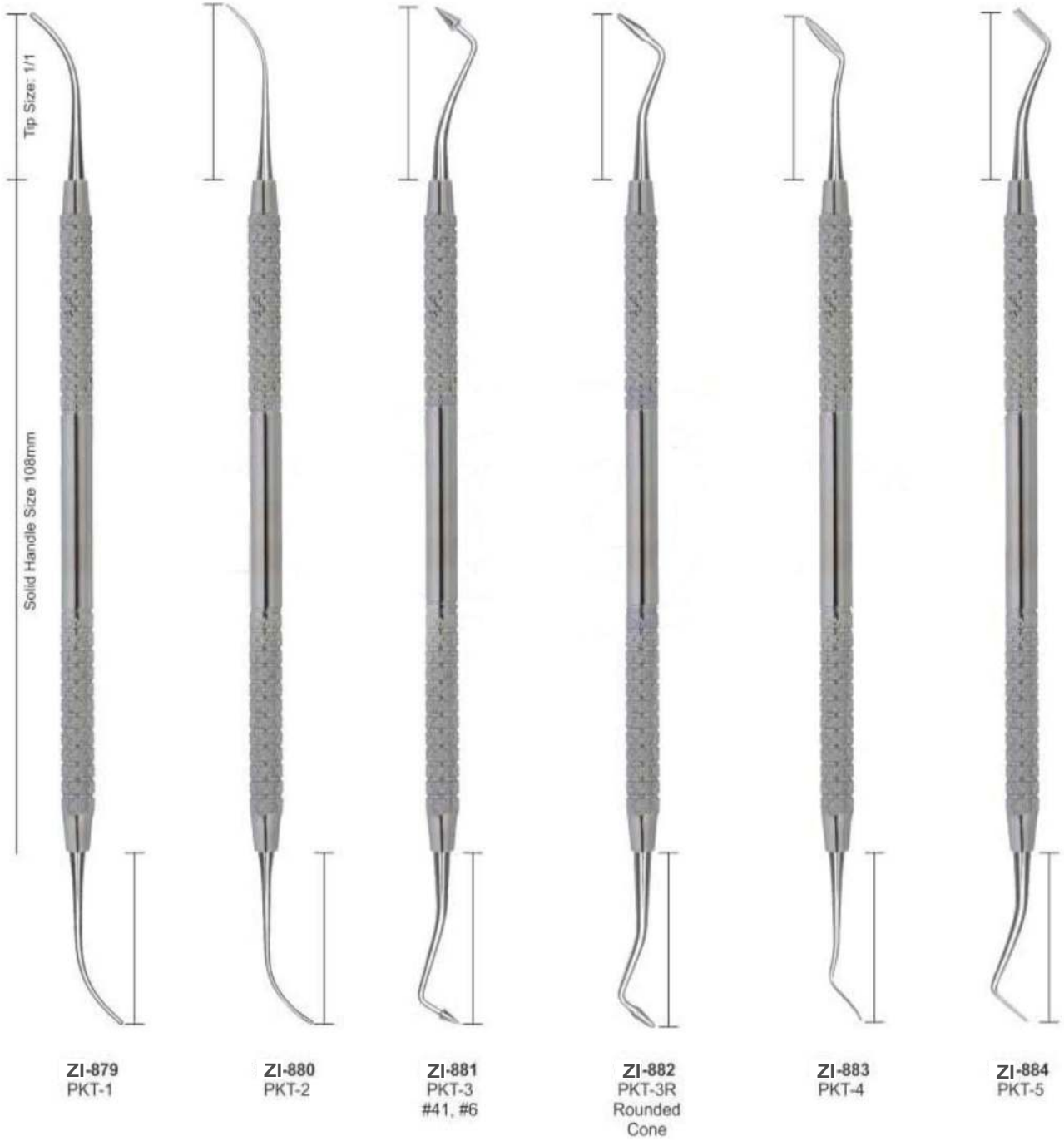
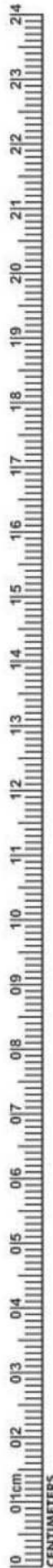

FILLING INSTRUMENTS

- Инструменты для реставрации
- Instruments pour plombage
- Füllungsinstrumente (mit Kontrawinkel)
- Инструменти для реставрації
- Instrumentos para obturaciones
- ملء الصكوك

CHISELS

HOES



INCHES

CEMENT SPATULAS

- Шпатели для цемента
- Spatules à ciment
- Zementspatel

- Шпателі для цементу
- Espátulas para cemento
- ملاعق الأسمنت



ZI-893
00



ZI-894
0



ZI-895
1



ZI-896
2



ZI-897
3



ZI-898
4



ZI-899
3
Weston



ZI-900
1
medium cement



ZI-901
1



ZI-902
Le Cron



ZI-903
Le Cron



ZI-904
Le Cron



ZI-905
MSY



ZI-906
MSY



ZI-907
Le Cron



ZI-908
Hylin



ZI-909
Hylin



ZI-910
Hylin



ZI-911
Zahle



ZI-912
Zahle



ZI-913
Zahle



ZI-914
Gritman

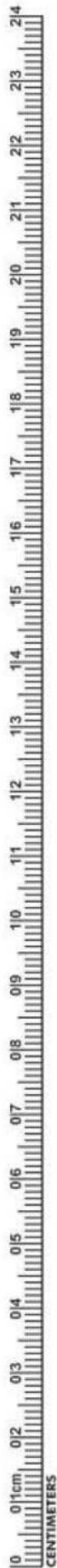

WAX KNIVES

- Ножи для воска
- Couteaux a cire
- Wachsmesser
- Ножи для воску
- Cuchillos para cera
- السكاكين الشمع

ALGINATE, PLASTER SPATULAS, WAX KNIVES PLASTER FOR KNIVES & PLASTER SHEAR



ZI-915
Wooden Handle
Fig. 5
21.5 cm



ZI-916
Wooden Handle
Fig. 7
19.5 cm curved



ZI-917
Wooden Handle
Fig. 8
20 cm curved



ZI-918
Wooden Handle
Fig. 9
22.5 cm curved



ZI-919
Hook Knives



ZI-920
Fig. 1
Lessmann
12.5 cm



ZI-921
Fig. 2
Lessmann
17 cm



ZI-922
Fig. 1
with small spoon
12.5 cm



ZI-923
Fig. 2
with large spoon
17 cm



ZI-924
Bacolite Handle
Wax Knives,
Small



ZI-925
Bacolite Handle
Wax Knives,
Large



ZI-926
Wooden Handle
Wax Knives,
Small



ZI-927
Wooden Handle
Wax Knives,
Large



ZI-928
Plaster Knife



ZI-929
Fig. 1
17 cm



ZI-930
Fig. 3
16 cm



ZI-931
Fig. 4
16 cm



ZI-932
Special Inox
19.5 cm



INCHES

ARTICULATORS

- Артикуляторы
- Artocilar
- Artikulations

- Артикулятори
- Articular
- ارتیکولاتورس



ZI-933

Technical Datas:

Intercondylar distance 120 mm.
 condylar inclination fixed at 30°
 Bennet angle fixed at 7°
 Incisal table inclination 10°
 Distance between mounting plates 85 mm.
 Weight 400 gr.
 Opening (item 5000) 125°
 Opening (item 5010) 180°



ZI-934

Technical Datas:

Intercondylar distance 110 mm.
 condylar inclination fixed at 30°
 Bennet angle fixed at 7°
 Incisal table inclination flat
 Distance between mounting plates 85 mm.
 Weight 450 gr.
 Opening 180°



ZI-935

Stainless Steel Finishing
ZI-936
 Royal Blue



ZI-937



ZI-938



ZI-939



ZI-940



ZI-941



ZI-942



ZI-943



ZI-944



ZI-945



ZI-946
 Nakawalni
 Dental Laboratory
 Instrument

MAXILLOFACIAL SURGERY INSTRUMENTS

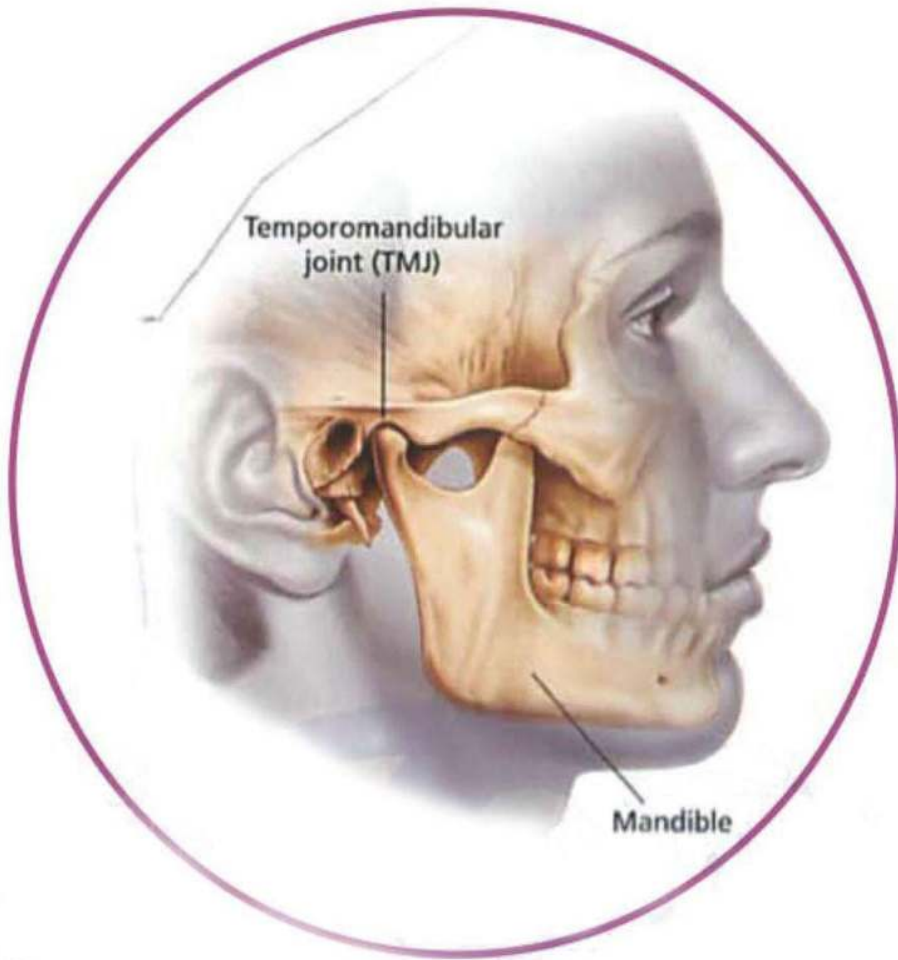

RETRACTORS - MOUTH GAGS

- Роторасширители
- Ecarteurs - Ouvre-bouches
- Vestibulumabhalter / Mundspanner
- Роторозширювачі
- Separadores - Abre-bocas
- الكاشحات - الكمامات الفم



ZI-947
Mouth Gag Molt
11 cm for (Children)



ZI-948
Mouth Gag Molt
14 cm for (Adults)



Cheek Retractor
ZI-949 140 mm
ZI-950 180 mm



Cheek Retractor
ZI-951 140 mm



ZI-952
Wangen Holder,
vestibule
15 cm, with or without
lip protection,



ZI-953
Wangen Holder,
vestibule 15 cm, with
or without lip protection,



ZI-954
Wangen Holder
Wangen holder with dual
function, 17 cm,



ZI-955
140 mm

ZI-956
150 mm

Cheek Retractor



CENTIMETERS

RETRACTORS - MOUTH GAGS

- Роторасширители
- Ecarteurs - Ouvre-bouches
- Vestibulumabhalter / Mundspanner
- Роторозширювачі
- Separadores - Abre-bocas
- الكاشطات - الكمامات الفم



Zl-957
Fig. 1
weitlaner
10.5cm
13.5cm



Zl-958
Fig. 2
weitlaner
10.5cm
13.5cm



Zl-959
Stainless Steel
Double
Ended Cheek
Retractors



Zl-960
Stainless Steel
Single
Ended Cheek
Retractors



Zl-961 Weitlander 11cm
Zl-962 13cm
Zl-963 15cm



Zl-967
Denhard
12 cm



Zl-968
Roser-König
16 cm



Zl-969
Roser-König
19 cm



Zl-964 Jennings 11cm
Zl-965 13cm
Zl-966 15cm



RETRACTORS

Wound, Bendable
Retractor, individually or as saving kit!

- Ранорасширители
- Ecarteurs
- Wundhaken

- Ранорозширювачі
- Separadores
- الكاشحات



Z1-970
Cheek Retractor
Long



Z1-971
Cheek Retractor
Long



Z1-972
Cheek Retractor
Long



**Retractor with
Ergo Grip
Z1-973** 24 cm,
ergonomic handle



Z1-974
Cheek Retractors,
Retractor Ivory
Width adjustable
& fixable, 20 cm,



**Cheek Retractors,
tongue depressors
Z1-975** 19 cm



**Cheek Retractors,
Minnesota
Z1-976** 16 cm



**Cheek Retractors,
Z1-977** 20 cm
easy to bend
by hand,



**Cheek Retractors,
retractor and tongue
pushers BISHOP with
comfortable margin,
Z1-978** 16 cm,



**Retractors Cheek
retractor combination
Combination,
Z1-979** 25 cm,

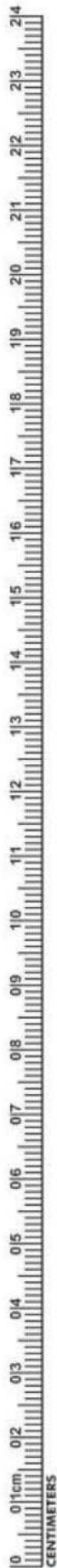

RETRACTORS

- Ранорасширители
- Ecarteurs
- Wundhaken
- Ранорозширювачі
- Separadores
- الكاشطات



ZI-982
Retractors, Unique
Length 175 mm,
angled 45°



ZI-983
Retractors, Unique
Length 175 mm,
angled 90°



ZI-984
Retractors
16cm



ZI-985
Retractors
19cm



ZI-986
Retractors, Mini-Langenbeck
16 cm, hooks 22 mm,



ZI-987
Retractors, Cheek
retractors combination
21 cm, 2



ZI-988
Mini Retractor
about 8 cm,



ZI-989
Retractors
17 cm, hooks 22 mm



INCHES

RETRACTORS

- Ранорасширители
- Ecarteurs
- Wundhaken
- Ранорозширювачі
- Separadores
- الكاشحات



ZI-990
Retractors, surgical-flat
surgically-flat, 21 cm, hook
30x16 mm,



ZI-991
Retractors, surgical-flat
surgically-flat, 21 cm, hook
42x11 mm



ZI-992
Retractors, surgical-flat
surgically-flat, 21 cm, hook
63x12 mm,



Retractors, surgical-flat
surgically-flat, 21 cm, hook
ZI-993 30x16 mm,
ZI-994 42x11 mm,
ZI-995 63x12 mm,



Retractors, Langenbeck
21 cm, hook
ZI-996 30x11 mm
ZI-997 30x16 mm,



ZI-998
Retractors
21 cm,



ZI-999
Farabeuf
(120 X 12mm
Set of 2 pices)



ZI-1000
Retractor Seldin



ZI-1001
FELDMAN
RETRACTOR
5-1/2", 14cm



GUM SCISSORS

- Ножницы десневые
- Ciseaux a gengivas
- Zahnfleischscheren
- Ножиці для ясен
- Tijeras para encias
- مقص صمغ



ZI-1002
Iris
115mm
Straight



ZI-1003
Iris
115mm
Curved



ZI-1004
Goldman-Fox
130mm
Saw edge, straight



ZI-1005
Goldman-Fox
130mm
Saw edge, Curved



ZI-1006
La Grange
115mm
Saw edge, double Curved



Mayo
ZI-1007 140mm
ZI-1008 170mm
ZI-1009 230mm
Straight



Mayo
ZI-1010 140mm
ZI-1011 170mm
ZI-1012 230mm
Curved



Metzenbaum
ZI-1013 145mm
ZI-1014 180mm
ZI-1015 200mm
Straight



Metzenbaum
ZI-1016 145mm
ZI-1017 180mm
ZI-1018 200mm
Curved



ZI-1019
Kelly
160mm
Straight



ZI-1020
Kelly
160mm
Curved



ZI-1021
Iris
115mm
Straight



ZI-1022
Iris
115mm
Curved



ZI-1023
La Grange
115mm
Double Curved



ZI-1024
Goldman-Fox
130mm, Straight



ZI-1025
Goldman-Fox
130mm, Curved



ZI-1026
Kelly
160mm, Curved



ZI-1027
Iris
115mm, Straight



ZI-1028
Iris
115mm, Curved



ZI-1029
Micro Iris
90mm, Curved



INCHES

GUM SCISSORS

- Ножницы десневые
- Ciseaux a gencives
- Zahnfleischscheren

- Ножницы для ясен
- Tijeras para encias
- مقص صمغ



ZI-1030
Iris
115mm
Angled



ZI-1031
Iris
115mm
Curved



ZI-1032
Goldman-Fox
130mm
Saw edge,
straight



ZI-1033
Goldman-Fox
130mm
Saw edge,
curved



ZI-1034
Goldman-Fox
130mm
Saw edge,
double curved



ZI-1035
La Grange
115mm
Saw edge,
double curved



ZI-1036
Neumann
120mm
Saw edge,
double curved



ZI-1037
Kilner (Ragnell)
120mm
Straight



ZI-1038
Kilner (Ragnell)
120mm
Curved



ZI-1039
Joseph
140mm
Straight



ZI-1040
Joseph
140mm
Curved



ZI-1041
Kelly
160mm
Straight



ZI-1042
Kelly
160mm
Curved



ZI-1043
Locklin
160mm
Saw edge,
angular



ZI-1044
Locklin
120mm
160mm
Saw edge,
angular



ZI-1045
Dean
170mm
Saw edge,
angular



ZI-1046
Spencer
90mm



ZI-1047
Spencer
130mm



ZI-1048
Spencer
115mm



ZI-1049
Noyes
110mm, Straight



ZI-1050
Noyes
110mm
Curved



ZI-1051
Noyes
110mm
Angular



ZI-1052
Castroviejo
150mm
Curved

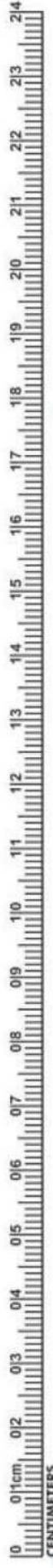

CENTIMETERS

NEEDLE HOLDERS

- Иглодержатели
- Porte-aiguilles
- Nadelhalter

- Голкотримачи
- Porta-agujas
- اصحاب ابرة



ZI-1053
130mm
Straight



ZI-1054
ZI-1055
ZI-1056

Mayo Mayo
130mm 130mm
160mm 160mm
180mm 180mm
Straight Curved



ZI-1057
ZI-1058

Mayo Mayo
140mm 140mm
200mm 200mm
Straight Curved



ZI-1059
ZI-1060

Metzenbaum
145mm 145mm
200mm 200mm
Straight Curved



ZI-1061
Beebee
110mm
Saw edge,
straight



ZI-1062
Beebee
110mm
Saw edge,
curved



ZI-1063
Beebee
110mm
Saw edge, straight



ZI-1064
Beebee
110mm
Saw edge, curved

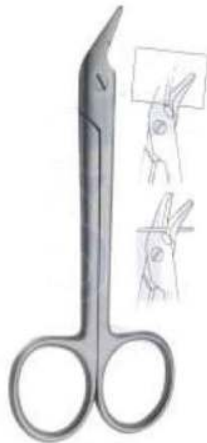

ZI-1065
Universal
120mm
Saw edge



ZI-1066
Universal
120mm



Crile
ZI-1067 130mm
ZI-1068 150mm
ZI-1069 180mm



ZI-1070
Halsey
130mm



ZI-1071
Baumgartner
130mm



ZI-1072
Derf
120mm



ZI-1073
Delicate
150mm



Mayo-Hegar
ZI-1074 130mm
ZI-1075 160mm
ZI-1076 180mm
ZI-1077 200mm



ZI-1078
Crile-Wood
150mm
straight



ZI-1079
Crile-Wood
150mm
curved



INCHES

NEEDLE HOLDERS

- Иглодержатели
- Porte-aiguilles
- Nadelhalter

- Голкотримачи
- Porta-agujas
- اصحاب ابرة

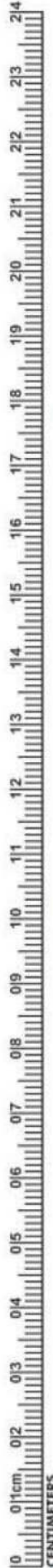

Castroviejo
ZI-1080 130mm
ZI-1081 150mm
ZI-1082 180mm



ZI-1083
 Halsey
 130mm



ZI-1084
 Baumgartner
 130mm



ZI-1085
 Derf
 120mm



ZI-1086
 Delicate
 150mm



ZI-1087
 Adson
 170mm



Mayo-Hegar
ZI-1088 130mm
ZI-1089 160mm
ZI-1090 180mm
ZI-1091 200mm



ZI-1092
 Crile-Wood
 150mm



Castroviejo
ZI-1093 str 140mm cvd
ZI-1094 str 180mm cvd



Olsen-Hegar Needle
 Holder With Scissors
ZI-1095 140mm



Gillies Needle
 Holder With Scissors
ZI-1096 160mm



Mathieu
ZI-1097 140mm
ZI-1098 170mm



Castroviejo
ZI-1099 str 140mm cvd
ZI-1100 str 180mm cvd



Olsen-Hegar Needle
 Holder With Scissors
ZI-1101 140mm



Gillies Needle
 Holder With Scissors
ZI-1102 160mm

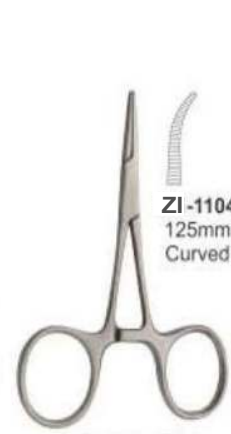

Hartmann (Baby
 Mosquito)
ZI-1103 90mm straight
ZI-1104 125mm
 Curved



Halstead Mosquito
ZI-1105 125mm
 Straight
ZI-1106
 Curved

HAEMOSTATIC FORCEPS & TOWEL CLAMPS

- Зажимы артериальные, зажимы для салфеток
- Pincers hemostaticques, Pincers a compresses
- Arterienklemmen, Tuyschklemmen
- Затискачі артеріальні, затискачі для серветок
- Pinzas hemostaticas, Pincers para compressas
- الملقط هيموستاتيک المشابك مشقة

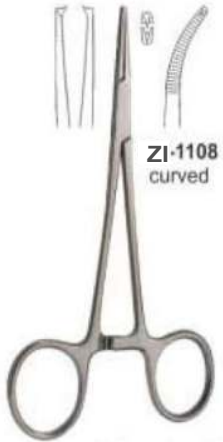

Halstead Mosquito 1x2
ZI-1107 125mm
straight



Kelly
ZI-1109 140mm
straight

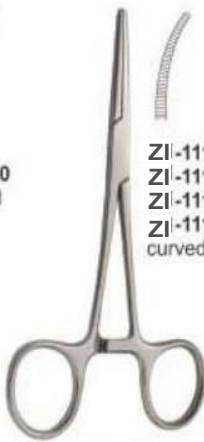

Rochester-Pean
ZI-1111 140mm
ZI-1112 160mm
ZI-1113 180mm
ZI-1114 200mm
straight



Rochester-Kocher 1x2
ZI-1119 140mm
ZI-1120 160mm
ZI-1121 180mm
ZI-1122 200mm
straight



ZI-1127
Kelly-Rankin
160mm
straight



Lorna
ZI-1129 100mm
ZI-1130 130mm



ZI-1131
Allis-Baby 3:4
150mm



ZI-1132
Allis 4:5
200mm



ZI-1133
Allis 6:7
200mm



Backhaus
ZI-1134 140mm
Not-perforating and
not-damaging



ZI-1135
Backhaus
130mm



ZI-1136
Backhaus
85mm



ZI-1137
Jones
90mm



BSI-1139
curved

Gross Maier
Dressing Forceps
ZI-1138 200mm straight



Foerster
Dressing Forceps
ZI-1140 200mm



Spare rubber

Young
Tongue Forceps
ZI-1141 170mm



Collins
Tongue Forceps
ZI-1142 170mm



RUBBER DAM CLAMPS FORCEPS

- Инструменты для системы коффердам
- Pincas porte-crampons a dique
- Kofferdam Klammerzangen
- Инструменти для системи коффердам
- Pinzas de engrapar para dique de caucho
- السد المطاط الملقط المشابك



ZI-1143

On request the Content of the rubber dam kit can be changed with other instruments.

Content:

- | | |
|------------------------------|------------------------------|
| 01 Anisworth | 08 Rubber Dam Clamp Fig. 212 |
| 02 Brewer | 09 Rubber Dam Clamp Fig. 211 |
| 03 Clamps Stand | 10 Rubber Dam Clamp Fig. 8 |
| 04 Denture Plate | 11 Rubber Dam Clamp Fig. 8A |
| 05 Rubber Dam Frame | 12 Rubber Dam Clamp Fig. 14 |
| 06 Rubber Dam Box Lower Case | 13 Rubber Dam Clamp Fig. 14A |
| 07 Rubber Dam Box Upper Case | 14 Rubber Dam Clamp Fig. 0 |
| | 15 Rubber Dam Clamp Fig. 00 |
| | 16 Rubber Dam Clamp Fig. 2 |
| | 17 Rubber Dam Clamp Fig. 2A |
| | 18 Rubber Dam Clamp Fig. 7 |



ZI-1144
Anisworth



ZI-1145
Brewer



ZI-1146
Ivory light weight



ZI-1147
Palmer



ZI-1148
Separating
Elastic
Plier

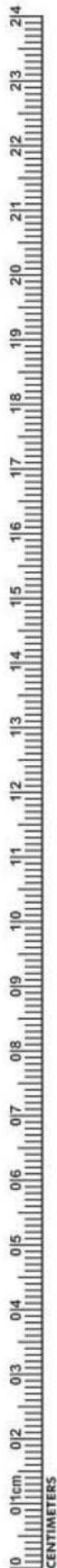

RUBBER DAM CLAMPS

- Кляммер для коффердама
- Crampons pour digue
- Kofferdam Klammern
- Кляммер для коффердама
- Grapas para dique de caucho
- المشبك السد المطاط



ZI-1149
Fig. 15



ZI-1150
Fig. 18



ZI-1151
Fig. 24



ZI-1152
Fig. 25



ZI-1153
Fig. 26



ZI-1154
Fig. 28



ZI-1155
Fig. 30



ZI-1156
Fig. 31



ZI-1157
Fig. 51



ZI-1158
Fig. 138



ZI-1159
Fig. 139



ZI-1160
Fig. 200



ZI-1161
Fig. 201



ZI-1162
Fig. 202



ZI-1163
Fig. 203



ZI-1164
Fig. 204



ZI-1165
Fig. 205



ZI-1166
Fig. 3



ZI-1167
Fig. W3



ZI-1168
Fig. 4



ZI-1169
Fig. 56A



ZI-1170
Fig. 7



ZI-1171
Fig. 7A



ZI-1172
Fig. 8



ZI-1173
Fig. 8A



ZI-1174
Fig. W8A



ZI-1175
Fig. 10



ZI-1176
Fig. 11



ZI-1177
Fig. 12A



ZI-1178
Fig. 13A



ZI-1179
Fig. 14



ZI-1180
Fig. 14A



ZI-1181
Fig. 14AN



ZI-1182
Fig. 22



ZI-1183
Fig. 27



ZI-1184
Fig. 207



ZI-1185
Fig. 29



ZI-1186
Fig. 206



ZI-1187
Fig. 208



ZI-1188
Fig. 209



ZI-1189
Fig. 1



ZI-1190
Fig. 1A



ZI-1191
Fig. 2



ZI-1192
Fig. 2A



ZI-1193
Fig. W2A



ZI-1194
Fig. 0



ZI-1195
Fig. 00



ZI-1196
Fig. 210



ZI-1197
Fig. 211



ZI-1198
Fig. 212



ZI-1199
Fig. 6



ZI-1199
Fig. 6



ZI-1200
Fig. 9



ZI-1200
Fig. 9



ZI-1201
Fig. N06



ZI-1202
Fig. U67



ZI-1203
Fig. 214



ZI-1204
Fig. P1



ZI-1205
Fig. P2



ZI-1206
Fig. G-1



ZI-1207
Fig. G-2



CROWN REMOVER

- Инструменты для удаления коронок
- Arrache-couronnes
- Teleskopkronenzangen
- Инструменти для видалення коронок
- Arranca-corona
- مزيلات التاج



ZI-1210
Crown Spreaders



ZI-1211
Mershon
14 cm
Band Pusher



ZI-1212
Fig. 0



ZI-1213
Manual Crown Remover



ZI-1214
Complete with 3 tips
and tightening keys

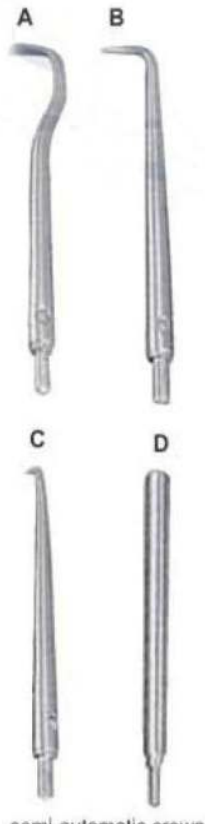

semi-automatic crown
& bridge remover



ZI-1215



ZI-1216
Manual Crown Remover

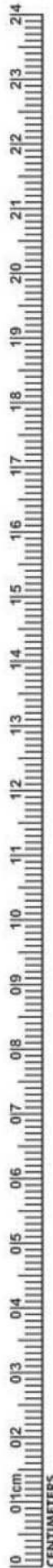

MATRIX RETAINERS

- Матрицедержатели
- Porte Matrices
- Matrizenspanner

- Матрицеутримувачи
- Porta Matrices
- مصفوفة الخدم



ZI-1217
Fig. 5
Ivory 8
5 cm



ZI-1218
Fig. 6
Ivory 8
6 cm



ZI-1219
Fig. 7
Ivory 8
7 cm



ZI-1220
Fig. 1
Tofflemire-Universal

Siqveland Retainers



ZI-1221
Fig. 2
Tofflemire-Junior



ZI-1222
Fig. 3
Tofflemire-Senior



ZI-1223
Narrow



ZI-1224
Wide

Amalgam Well



ZI-1225
Stainless Steel
Amalgam Well



ZI-1226
Ivory 12



ZI-1227
Ivory 1



ZI-1228
Ivory



ZI-1229
Elliot



AMALGAM INSTRUMENTS & SCALPEL HANDLES

Инструменты для амальгамы
 • Instruments pour amalgame
 • Amalgamis/strumente

• Инструменты для амальгами
 • Instrumentos para amalgama
 • الصكوك المنقح

• Ручки для скальпелей
 • Manches de bistouris
 • Skalpellgriffe

• Ручки для скальпелей
 • Mangos de bisturi
 • مشط مغنايش



ZI-1230

Fig. 10

165mm

English pattern



ZI-1231

Fig. 1

185mm

German pattern



ZI-1232

Fig. 1

150mm

Swiss pattern



ZI-1233

Fig. 1

150mm



ZI-1234

Fig. 2

150mm, 45°



ZI-1235

Fig. 3

140mm, 90°



ZI-1236

Fig.3

5" (12.7cm)



ZI-1237

Fig.3G

5" (12.7cm)



ZI-1238

Fig.4

5 1/2" (13.7cm)



ZI-1239

6 Way Adjustable Angled Scalpel Handle



Locks At 90°, 60°, 30°,
 Straight, 120°, 150°, 180°,
 Angles

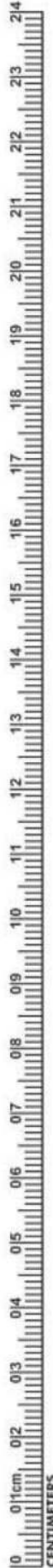

AMALGAM INSTRUMENTS

- Инструменты для амальгамы
- Instruments pour amalgame
- Amalgamisinstrumente
- Инструменти для амальгами
- Instrumentos para amalgama
- الصكوك الملقم

AMALGAM CARRIERS



ZI-1240
Distal
Improves visibility
and access to
posterior regions.

ZI-1241
Single-End

ZI-1242
Double-End



ZI-1251
Amalgam
Well



ROOT PLANNING FILES & BONE FILES

ROOT PLANNING FILES



ZI-1252
Kramer-Nevins
Bone Chisel



ZI-1253
Kramer-Nevins
Bone Chisel



ZI-1254
Molt 18.5cm
Auto Clavable
Plastic Tips.



ZI-1255
Mead 18.5cm
Non Auto Clavable
Plastic Tips.



ZI-1256
Miller



ZI-1257
Miller

BONE FILES



ZI-1258
Miller 21



ZI-1259
Miller 1X
cross cut



ZI-1260
Miller 2X
cross cut



ZI-1261
Miller 52



ZI-1262
Wahl 1

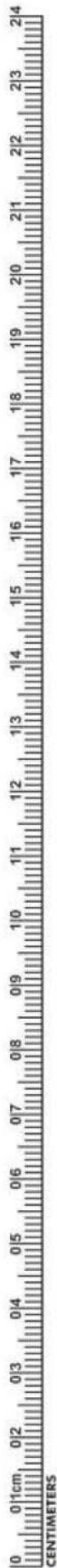

PERIODONTAL INSTRUMENTS

- Инструменты пародонтологические
- Instruments pour la parodontologie
- Instrumente für die Parodontologie
- Инструменти пародонтологічні
- Instrumentos para periodoncía
- الصوك اللثة

PERIOSTEEL ELEVATORS



ZI-1263 BUSER
ZI-1264 Ohl 10
ZI-1265 Howard 9H
ZI-1266 Freer
ZI-1267 Freer 15
ZI-1268 Freer 16
ZI-1269 Molt 9
ZI-1270 Allen 9A
ZI-1271 Prichard 3



ZI-1272 Seldin 23
ZI-1273 Goldman-Fox 14
ZI-1274 P 24G
ZI-1275
ZI-127A
ZI-127B
Raspator, Raspatory
 Length 175 mm,
ZI-1276
ZI-1276A
ZI-1276B
Raspator, Williger
 Length 170 mm, different widths
 (4 mm, 5 mm or 7 mm),



ORTHODONTIC INSTRUMENTS



Behind Every Smile is a Story

• QUALITY - ЯКІСТЬ • PRECISION - ТОЧНІСТЬ • ACCURACY - ПРАВИЛЬНІСТЬ • DURABILITY - ЗНОСОСТІЙКІСТЬ



- Super-sharp diamond bevel cutter
- smooth ultra-polished and contoured edges
- brilliant corrosion resistant stainless steel finish
- superior 1-12 stainless steel and carbon
- sliding lock joint for balance & precise alignment
- Super-sharp diamond bevel cutter
- smooth ultra-polished and contoured edges
- brilliant corrosion resistant stainless steel finish
- superior T10 stainless steel and carbon
- sliding lock joint for balance & precise alignment

STYLE
A

STYLE
B

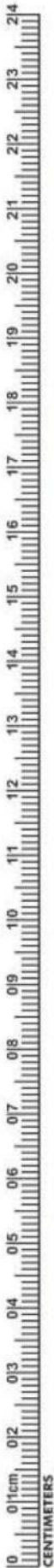

CENTIMETERS

ORTHODONTIC INSTRUMENTS

- Инструменты ортодонтические
- Instrumentos Ortodonticos
- Orthodontische Instrumente
- Інструменти ортодонтичні
- Instruments Orthodontiques
- أدوات تلويح الأسنان



ZI-1277
Aluminum Height
Gauge 0.22



ZI-1278
Aluminum Height
Gauge 0.18



ZI-1279
Bone Bracket Gauge



ZI-1280
Bone Thickness Gauge
40mm, 180mm



ZI-1281 OSTEOMETER
Measuring Forceps For Jaw
Ridge Width measurement, scale
on both sides, rustfree, autoclavable



ZI-1282
Direct bonding
bracket holders,
135mm



ZI-1283
Deluxe Bracket
Holder Tweezers



ZI-1284
Direct bonding
bracket holders,
136mm



ZI-1285
Direct Bond
Bracket Holder
Tweezers,
Small Tip



ZI-1286
Direct bonding
bracket holders,
140mm



ZI-1287
Direct bonding
bracket holders,
135mm



ZI-1288
Direct Bonding
Bracket Holders,
140mm



INCHES

ORTHODONTIC INSTRUMENTS

- Инструменты ортодонтические
- Instrumentos Ortodonticos
- Orthodontische Instrumente

- Инструменти ортодонтични
- Instruments Orthodontiques
- أدوات تلويم الأسنان



ZI-1289
Band seater auto cleavable



ZI-1290
Ortho light scaler double ended



ZI-1291
Ortho light scaler double ended



ZI-1292
Ortho light scaler double ended



ZI-1293
Twiel-on elastic module instrument



ZI-1294
Twiel-on elastic module instrument



ZI-1295
Schure Band Seater



ZI-1296
Ortho light scaler



ZI-1297
Ortho light scaler



ZI-1298
Ortho light scaler heavy



ZI-1299
Ortho instrument



ZI-1300
Ortho instrument



ZI-1301
Ortho Light Band Pusher Scaler

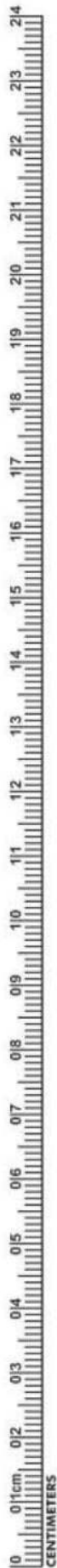

ORTHODONTIC INSTRUMENTS

- Инструменты ортодонтические
- Instrumentos Ortodonticos
- Orthodontische Instrumente
- Інструменти ортодонтичні
- Instruments Orthodontiques
- أدوات تلويم الأسنان



ZI-1302
Ortho Light double ended
ligature director



ZI-1303
Ortho Light double ended
ligature director scaler



ZI-1304
Ortho Light double ended ligature scaler director tivate coil spring
are remove modules with one instruments



ZI-1305
Ortho band pusher scaler



ZI-1306
Ortho Light Band Pusher Scaler



ZI-1307
Ortho ligature director single ended



ZI-1308
Ortho Light double ended ligature
director scaler



ZI-1309
Ortho Light double ended ligature scaler/director
tivate coil spring are remove modules with one instruments



ZI-1310
Ortho Light double ended ligature director



ZI-1311
Ortholite Ligature Director Scaler



ZI-1312
Ortho light ligature director double ended



ZI-1313
Double ended cement spatula



ZI-1314
Ortho light scaler single ended



PLIERS FOR ORTHODONTICS & PROSTHETICS

- Щипцы для ортодонтии и протезирования
- Pinces pour l'orthodontie et la prothèse
- Zangen für Kieferorthopädie und Prothetik

- Щипці для ортодонті та протезування
- Alicates para ortodoncia y prótesis
- كمشة لتكوين الأسنان بروماتيس

BOX JOINT PLIERS

ZI-1315
Universal Dolphin Style
Wire Bending & cutting pliers



ZI-1316 Band Removing Plier
The curved blade of the band removing plier can strip easily and gently remove directly to the tooth. Length 130mm



ZI-1317
Tweed Loop forming Pliers



ZI-1318
How Plier curved
Universally usable tool for the multiband technology for wires up to .028". Length 130mm



ZI-1319 How Plier
Universally usable tool for the multiband technology for wires up to .028". Length 135mm



ZI-1320
Nance Loop forming Pliers



ZI-1321
Bracket Removing Plier curved
Bracket Removing Plier curved for easy removal of brackets in the posterior region. Length 130mm



ZI-1322
Young Wire Bending & Loop Forming Pliers



ZI-1323
Wire Bending & Loop Forming Pliers



ZI-1324
Adams, small wire bending and loop forming Pliers



ZI-1325
Bracket Removing Plier Round Box
Bracket removing plier for comfortable and quick removal of the brackets. Length 135mm



ZI-1326
Weingart Plier medium
Weingart plier that are ideal due to their curved tip for setting sheets and is capable of bending the ends. Length 145mm

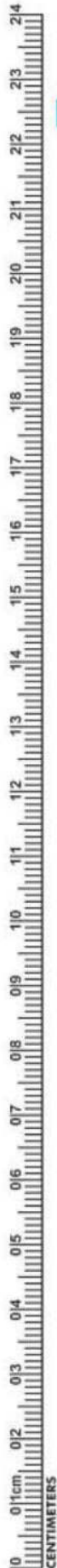
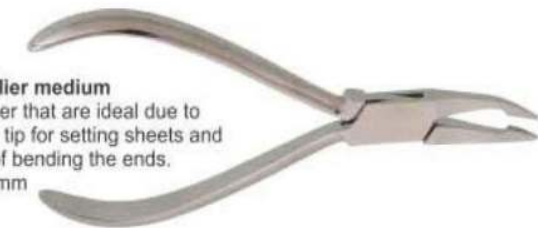

PLIERS FOR ORTHODONTICS & PROSTHETICS

- Щипцы для ортодонтии и протезирования
- Pincers pour l'orthodontie et la prothèse
- Zangen für Kieferorthopädie und Prothetik
- Щипці для ортодонції та протезування
- Alicates para ortodoncia y prótesis
- كمانشة لتقويم الأسنان بروستيتيس

BOX JOINT PLIERS

ZI-1327 Adams Plier Round Box

Adams pliers for bending wire arches and bends right angles for wires up to .022", .025 tip to beak. Length 125mm

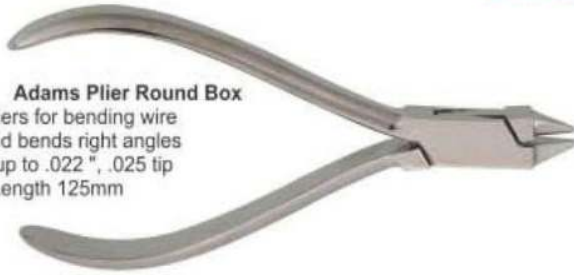

ZI-1328 Falcon Beak Contouring Pliers.



ZI-1329 wires up to 0.020" / 0.7mm.



ZI-1330 Johnson Contouring Pliers



ZI-1331 Aderer Large wire bending and loop forming pliers



ZI-1332 Tweed / angle rectangular arch forming & Torquing pliers



ZI-1333 Adams Plier

Adams pliers for bending wire arches and bends right angles for wires up to .022", .025 tip to beak. Length 125mm



ZI-1334 Tweed Loop Formin Pliers



ZI-1335 Bird Beak Plier Standard Bird Beak Wire bending plier without notches, which is suitable as a universal utility tool. Length 125mm



ZI-1336 Mini Ligature cutters



ZI-1337 Small Fluch-cut distal and cutting Pliers with safety hold fitted with un-breakable, corrosion resistant and durable stainless steel tips



ZI-1338 Large Fluch-cut distal and cutting Pliers with safety hold fitted with un-breakable, corrosion resistant and durable stainless steel tips



PLIERS FOR ORTHODONTICS & PROSTHETICS

- Щипцы для ортодонтии и протезирования
- Pincers pour l'orthodontie et la prothèse
- Zangen für Kieferorthopädie und Prothetik

- Щипці для ортодонті та протезування
- Alicates para ortodoncia y prótesis
- كمشة لتكوين الأسنان بروماتیس

BOX JOINT PLIERS

ZI-1339

Tweed / Angel
1.78mm (.070") wide tips arch forming and torquing pliers



ZI-1345

Contouring Plier



ZI-1340

Tweed / Angel
1.78mm (.070") wide tips arch forming and torquing pliers

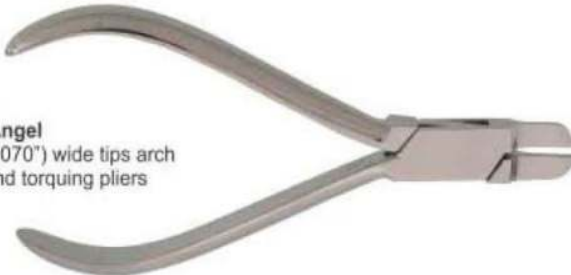

ZI-1346

Bands & Crowns Plier
in order to skirt



ZI-1341

Lingual / Palatal arch forming pliers



ZI-1347

Ligature Forming Pliers



ZI-1342

Aderer
Facebow loop forming Pliers



ZI-1348

for double back and triple back bands in 0.30" / 0.76mm & 0.36" / 0.91mm lingual arch wires



ZI-1343

Waldsahvs wire bending and cutting pliers



ZI-1349

Bird Beak Wire Bending & cutting pliers



ZI-1344 **Aderer Plier**

For the manufacturing of appliances and activation of wires for wires up to .030" .fine tip and up to .036" mean tip. Length 130mm



ZI-1350

Weingart Plier medium
Weingart plier that are ideal due to their curved tip for setting sheets and is capable of bending the ends. Length 145mm

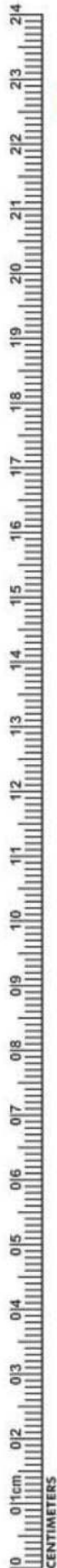

PLIERS FOR ORTHODONTICS & PROSTHETICS

- Щипцы для ортодонтии и протезирования
- Pincers pour l'orthodontie et la prothèse
- Zangen für Kieferorthopädie und Prothetik
- Щипці для ортодонції та протезування
- Alicates para ortodoncia y prótesis
- كمانة لتقويم الأسنان بروستیس

LAP JOINT PLIERS



ZI-1351
Distal End Cutter
Regular with T.C

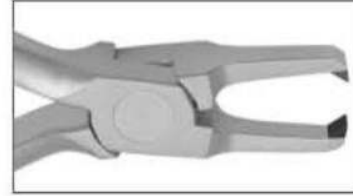

ZI-1358
Bracket Remover Pliers
Straight With T.C



ZI-1352
Hard Wire Cutter With T.C



ZI-1359
Bird Beak Plier With TC



ZI-1353
Ligature Cutter Angled
15° With T.C

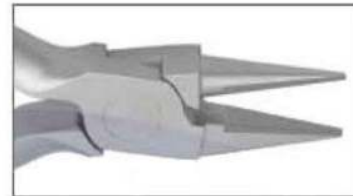

ZI-1360
Light Wire Bird Beak
Long Plier With TC



ZI-1354
Light Wire Cutter Micro
With T.C



ZI-1361
Adam Plier With TC



ZI-1355
Reversed Ligature
Cutter Angled
40° With T.C



ZI-1362
Tweed Arch Forming Plier
1.78mm With TC

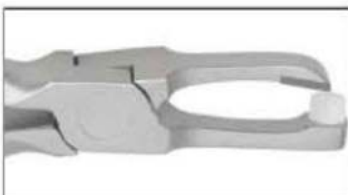

ZI-1356
Posterior Band Remover Pliers
Long With T.C



ZI-1363
Weingart Plier Slim
With TC



ZI-1357
Posterior Band Remover Pliers
Medium With T.C

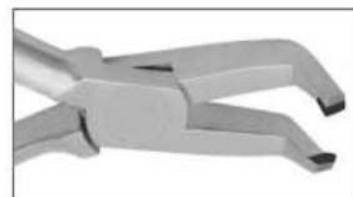

ZI-1364
Bracket Remover Pliers
Angled With T.C



INCHES

PLIERS FOR ORTHODONTICS & PROSTHETICS

- Щипцы для ортодонтии и протезирования
- Pincers pour l'orthodontie et la prothèse
- Zangen für Kieferorthopädie und Prothetik

- Щипці для ортодонції та протезування
- Alicates para ortodoncia y prótesis
- كمشة لتكوين الأسنان برومبیتس

LAP JOINT PLIERS

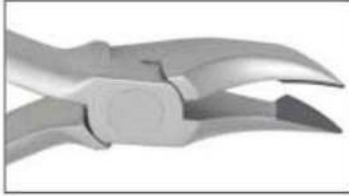

ZI-1365
Weingart Plier Regular
With TC

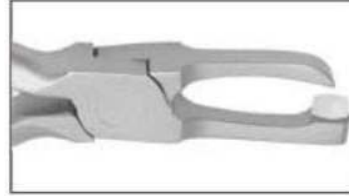

ZI-1372
Posterior Bend Remover
Plier Long

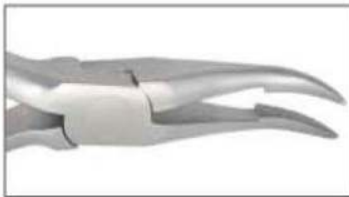

ZI-1366
Weingart General Utility Plier
Long Mouth With TC

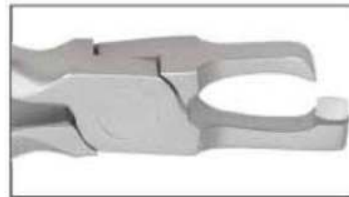

ZI-1373
Posterior Bend Remover
Plier Short

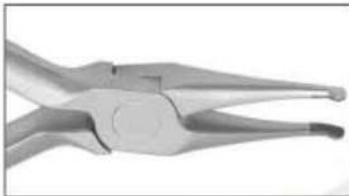

ZI-1367
How Plier Straight
With TC



ZI-1374
Posterior Bend Remover
Plier Medium

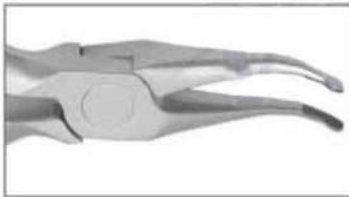

ZI-1368
How Plier Curved
With TC

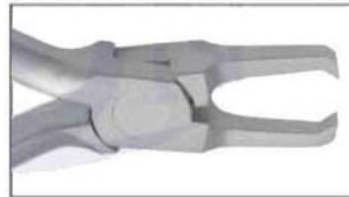

ZI-1375
Bracket Remover Plier
Straight



ZI-1369
Step Pliers with T.C
0.5mm

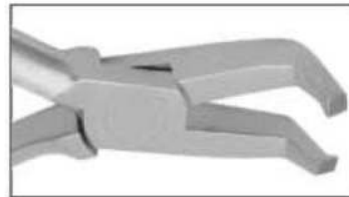

ZI-1376
Bracket Remover
Angulated
Plier



ZI-1370
Weingart Plier Utility
With TC

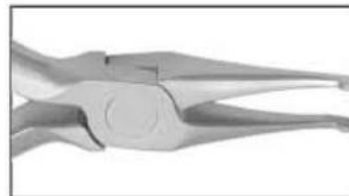

ZI-1377
How Plier Straight

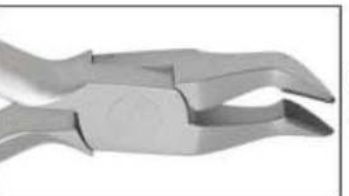

ZI-1371
Weingart Plier Universal
With TC 45°



ZI-1378
Bird Beak Angled
Bending Plier

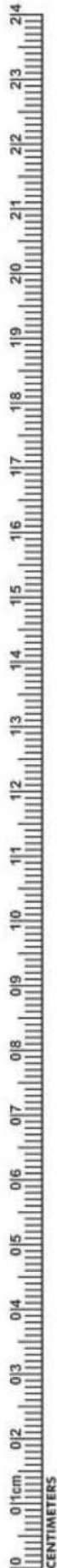

PLIERS FOR ORTHODONTICS & PROSTHETICS

- Щипцы для ортодонтии и протезирования
- Pincers pour l'orthodontie et la prothèse
- Zangen für Kieferorthopädie und Prothetik
- Щипці для ортодонції та протезування
- Alicates para ortodoncia y prótesis
- كمامة لتقويم الأسنان بروستيثيس

LAP JOINT PLIERS

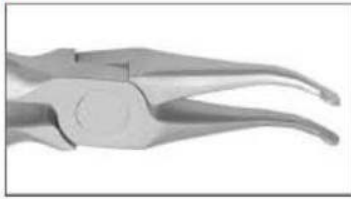

ZI-1379
How Plier Curved

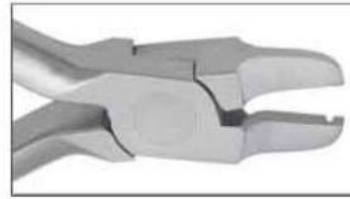

ZI-1386
Tweed Cutter Plier With Groove



ZI-1380
Hammer Head Tie Back Plier



ZI-1387
Round Nose Plier

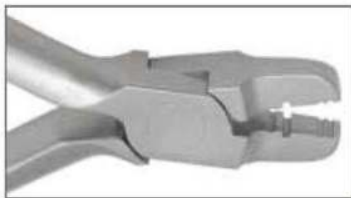

ZI-1381
Arch Forming Pliers



ZI-1388
Adam Plier

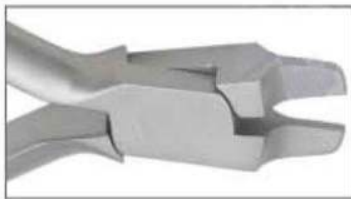

ZI-1382
Regular Tweed Arch Forming Pliers 1.78mm

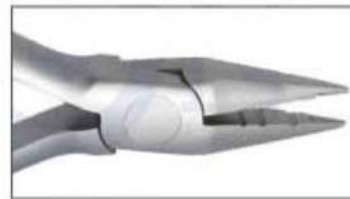

ZI-1389
Jara Beak Plier



ZI-1383
Bird Beak with Cutter Pliers 3 Groove

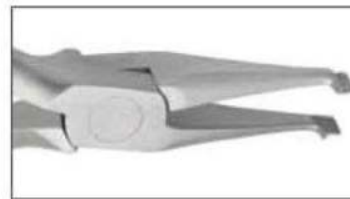

ZI-1390
Band Seating Plier

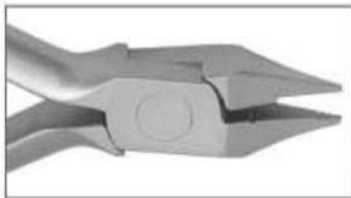

ZI-1384
Light Wire Bird Beak Pliers With Groove

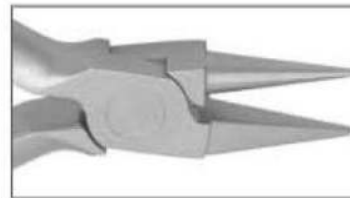

ZI-1391
Light Wire Bird Beak Long Plier

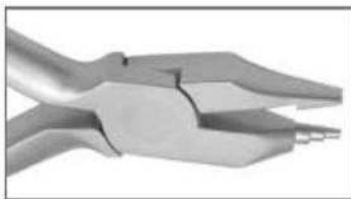

ZI-1385
Tweed Loop Plier



ZI-1392
Light Wire plier two step groove 0.51mm/.020"



INCHES

PLIERS FOR ORTHODONTICS & PROSTHETICS

- Щипцы для ортодонтии и протезирования
- Pincers pour l'orthodontie et la prothèse
- Zangen für Kieferorthopädie und Prothetik

- Щипці для ортодонції та протезування
- Alicates para ortodoncia y prótesis
- كمشة لتقويم الأسنان بروستتیس

LAP JOINT PLIERS

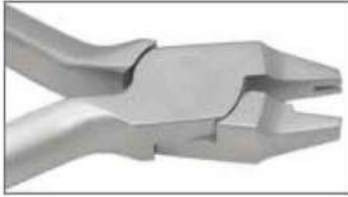

ZI-1393
Ball Hook Crimping Plier



ZI-1394
Marcotte Looping Plier



ZI-1395
Tweed Loop Plier

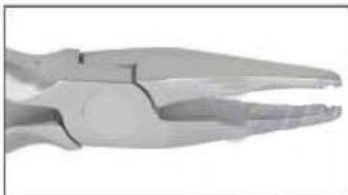

ZI-1396
Palatal Arch Plier

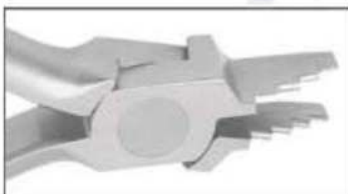

ZI-1397
Nance Plier



ZI-1398
Young Plier with Grooved



ZI-1399
Wingurt Plier Slim



ZI-1400
Tweed loop Forming
Plier TC.

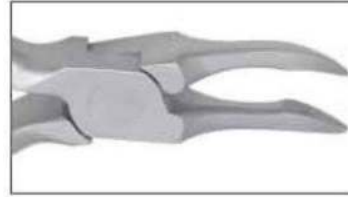

ZI-1401
Wingurt Utility Plier



ZI-1402
De La Rosa Pliers
with Grooved



ZI-1403
De La Rosa Pliers

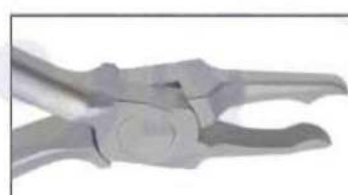

ZI-1404
Crown and Band
Contouring Pliers



ZI-1405
Flat Nose Plier with Serration



ZI-1406
Flat Nose Plier Smooth

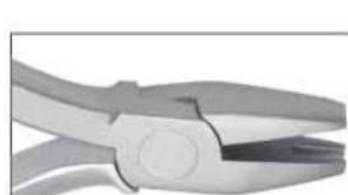

ZI-1407
Stop V Bending Plier

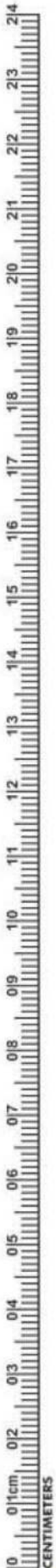

PLIERS FOR ORTHODONTICS & PROSTHETICS

- Щипцы для ортодонтии и протезирования
- Pincers pour l'orthodontie et la prothèse
- Zangen für Kieferorthopädie und Prothetik
- Щипці для ортодонції та протезування
- Alicates para ortodoncia y prótesis
- كمانشة لتقويم الأسنان بروستتیس

LAP & L-KEY JOINT PLIERS

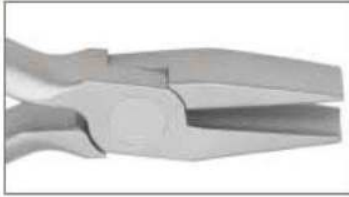

ZI-1408
Hollowchop Contouring
Pliers



ZI-1409
Lap-Joint Three Prong Plier



ZI-1410
Three Prong Pliers Regular

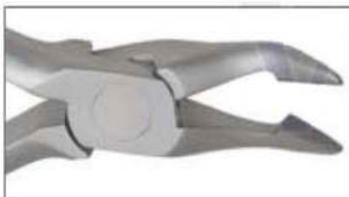

ZI-1411
Lingual Plier Weingart
Regular Long Handle 35°



ZI-1412
Lingual Plier Long Handle
90° Angled

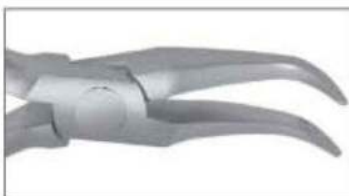

ZI-1413
Lingual Weingart Plier Fine
Long Handle 60° Angled



ZI-1414
Direct Bonding Bracket
Remover Plier TC.



ZI-1415
Pin & Ligature Cutters
TC.



ZI-1416
Mini Pin & Ligature
Cutter TC.



ZI-1417
Standard Ligature
Cutter TC.



ZI-1418
V Bend Stop Plier
TC.



ZI-1419
Angled Direct Bond Bracket
Remover TC.



INCHES

DISTAL END, WIRE CUTTERS & BRACKET REMOVER PLIERS

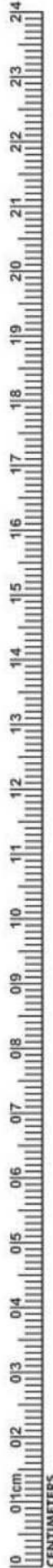

ZI-1420
Distal end Cutter, Safety Hold Plier
(Ideal for Cutting Wire) TC.



ZI-1421
Hook Crimping Plier Angled
Straight TC.



ZI-1422
3 Prong Clasp Adjustable
Plier TC.



ZI-1423
Utility Plier Weingart TC.



ZI-1424
Direct Bracket Remover
TC.



ZI-1425
Straight Direct Bond Bracket
Remover TC.



ZI-1426
Pin Holding Plier TC.



ZI-1427
Hard wire cutters



ZI-1428
Elastic Separating Plier
Round Handle



ZI-1429
Elastic
Separating Plier



ZI-1430
ZI-1431
Smaha
Elastomeric
ligature
placing forceps
140 mm



ZI-1432
Elastomeric
ligature placing
forceps with
groove
Falcon 140 mm



ZI-1433
Elastomeric
ligature placing
forceps with
groove
Falcon 140 mm

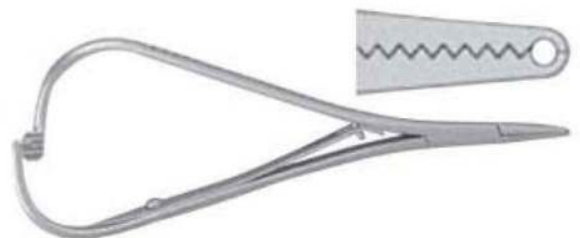

Normal Anatomy – Dental Implants

Bone Level Normal
(No Bone Loss)

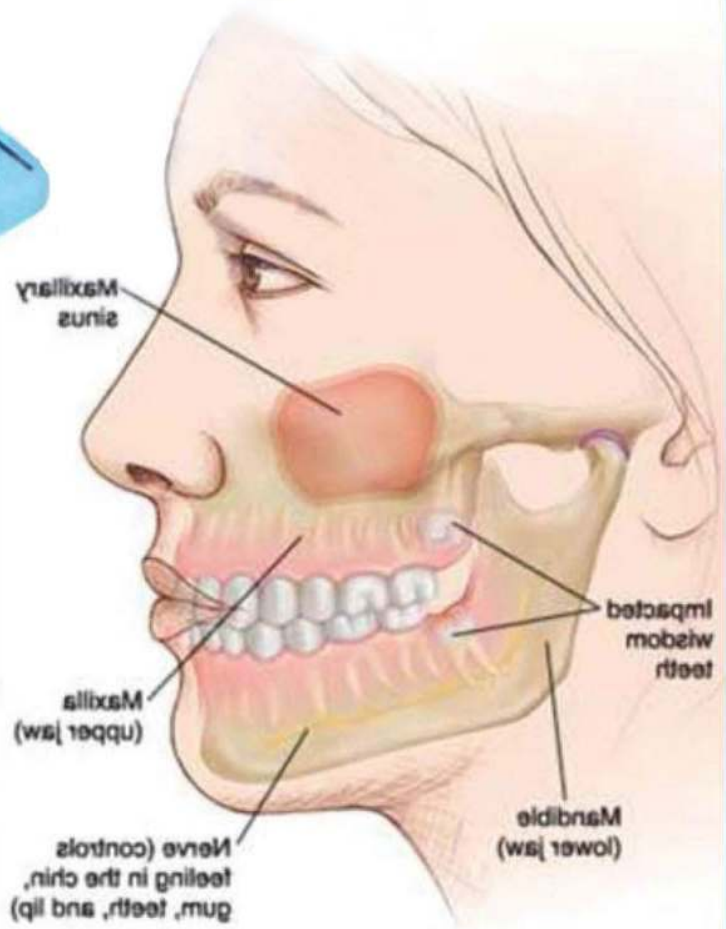
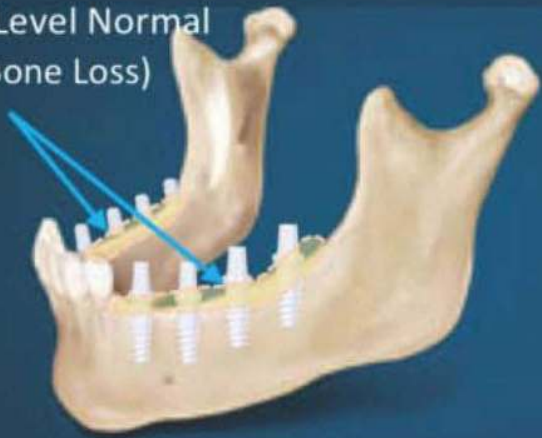

- Инструменты для имплантологии
- Implantologie
- Implantologie

- Інструменти для імплантології
- Implantologia
- زراعة الأسنان

IMPLANT GAGES



ZI-1434
Multifunctional Meter
 Length 90 mm,
 different sizes,
 8-10-11mm,
 corrosion-resistant

ZI-1435
Multifunctional Meter
 Length 90 mm,
 different sizes,
 5-13-15-17 mm,
 corrosion-resistant

ZI-1436
Measuring Probe
 Length 170 mm,
 hand shape or flexible
 (6-8-10-14-16 mm),
 corrosion-resistant

ZI-1437

ZI-1438

ZI-1439

ZI-1440

IMPLANT GAGES



ZI-1441

ZI-1442

ZI-1443

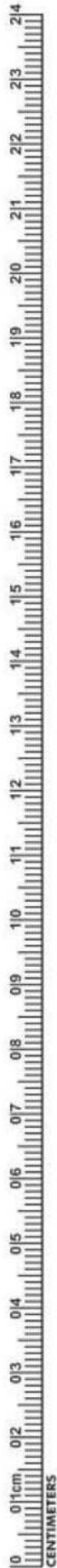

IMPLANTOLOGY

- Инструменты для имплантологии
- Implantologie
- Implantologie

- Инструменти для имплантології
- Implantoloia
- زراعة الأسنان



ZI-1444
Clamp, Osteometer
Length about 155 mm,
ridge width measurement,
two-sided scale,
measuring
range 0 - 25 mm



ZI-1445
Measuring Loop
straight length 90 mm,
measuring range
0 - 40 mm,



ZI-1446
Measuring Loop
angled, length 90 mm,
measuring range
0 - 40 mm,



ZI-1447
Measuring loop, Castroviejo
angled, length 175 mm,
measuring range 0 - 40 mm,
with window



ZI-1448
Boley Gauge
Stainless Steel



ZI-1449
Measuring Loop
angled, length
175 mm,
measuring range
0 - 40 mm,



ZI-1450
Measuring Loop
straight length
175 mm,
measuring range
0 - 40 mm,



ZI-1451
Fig. 1
Iwanson
spring caliper
For metal and
porcelain.



ZI-1452
Fig. 2
Iwanson
spring caliper
For wax.



ZI-1453
Bone Thickness Gauge
40mm, 180mm



ZI-1454
Gauge
for measuring
distances
(0 - 90 mm),



- Инструменты для имплантологии
- Implantologie
- Implantologie

- Інструменти для імплантології
- Implantologia
- زراعة الأسنان

BLACK TITANIUM COLOUR COATED INSTRUMENTS

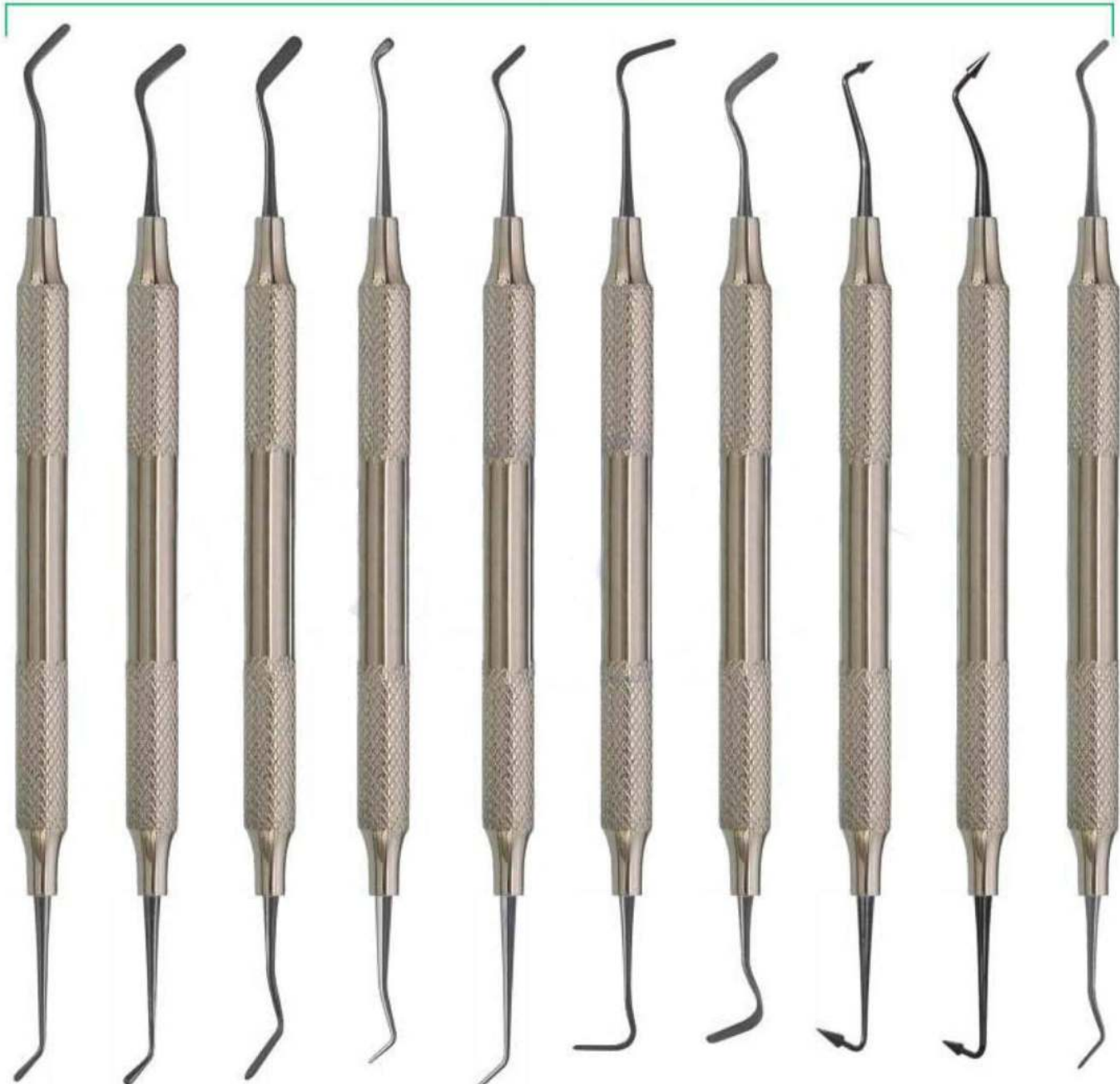

ZI-1455 #1	ZI-1456 #2	ZI-1457 #3 Extra-Flex	ZI-1458 Micro-Mini	ZI-1459 Mini 1	ZI-1460 Mini 4 Extra-Flex	ZI-1461 #4 Extra-Flex	ZI-1462 #5 Flexi-Thin	ZI-1463 #6 Flexi-Thin	ZI-1464 Mini 3 Extra-Flex
---------------	---------------	-----------------------------	-----------------------	-------------------	---------------------------------	-----------------------------	-----------------------------	-----------------------------	---------------------------------

IMPLANTOLOGY

- Инструменты для имплантологии
- Implantologie
- Implantologie
- Инструменти для імплантології
- Implantoloia
- زراعة الأسنان

BLACK TITANIUM COLOUR COATED INSTRUMENTS

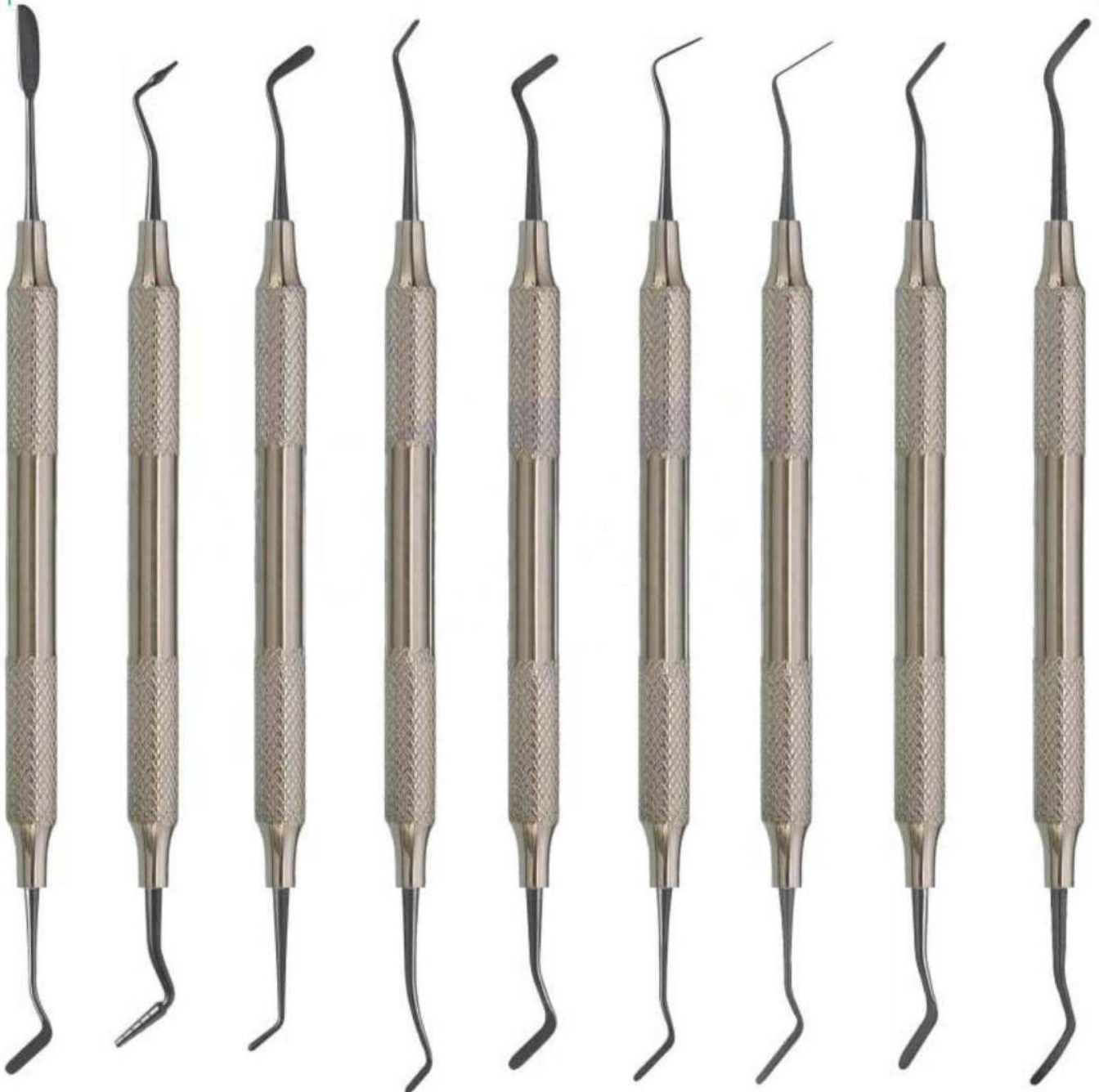

ZI-1465
AB1
Boghosian

ZI-1466
AB2
Boghosian

ZI-1467
W3

ZI-1468
8A

ZI-1469
4/5
Gregg

ZI-1470
Interproximal
Carver

ZI-1471
Interproximal
Carver, Long

ZI-1472
A6

ZI-1473
Contouring
instrument



INCHES

- Инструменты для имплантологии
- Implantologie
- Implantologie

- Инструменти для імплантології
- Implantologia
- زراعة الأسنان

BLACK TITANIUM COLOUR COATED INSTRUMENTS

BURNISHERS

FREEDMAN BURNISHERS

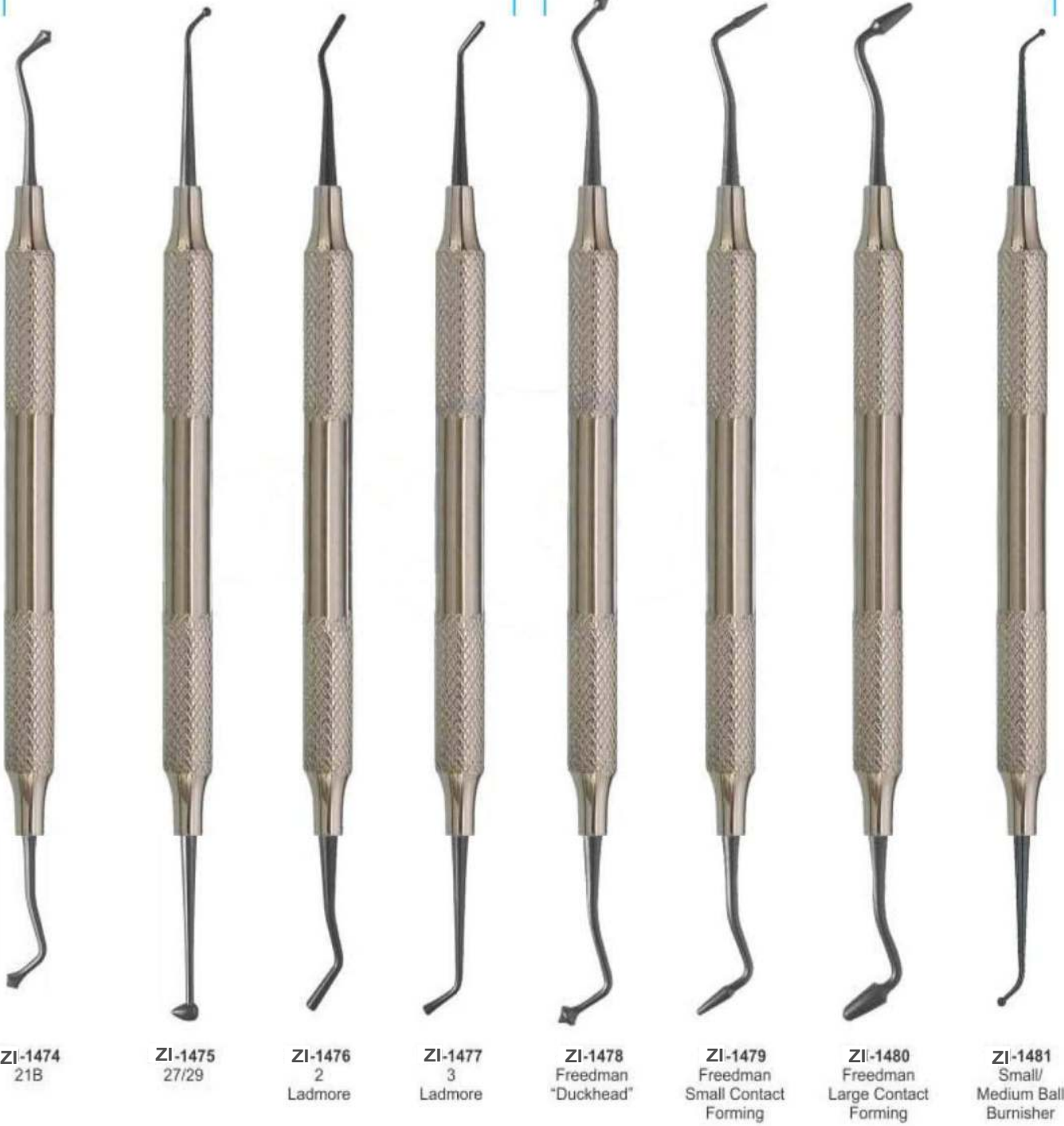

ZI-1474
21B

ZI-1475
27/29

ZI-1476
2
Ladmore

ZI-1477
3
Ladmore

ZI-1478
Freedman
"Duckhead"

ZI-1479
Freedman
Small Contact
Forming

ZI-1480
Freedman
Large Contact
Forming

ZI-1481
Small/
Medium Ball
Burnisher

IMPLANTOLOGY

- Инструменты для имплантологии
- Implantologie
- Implantologie
- Инструменти для имплантології
- Implantoloia
- زراعة الأسنان

BLACK TITANIUM COLOUR COATED INSTRUMENTS

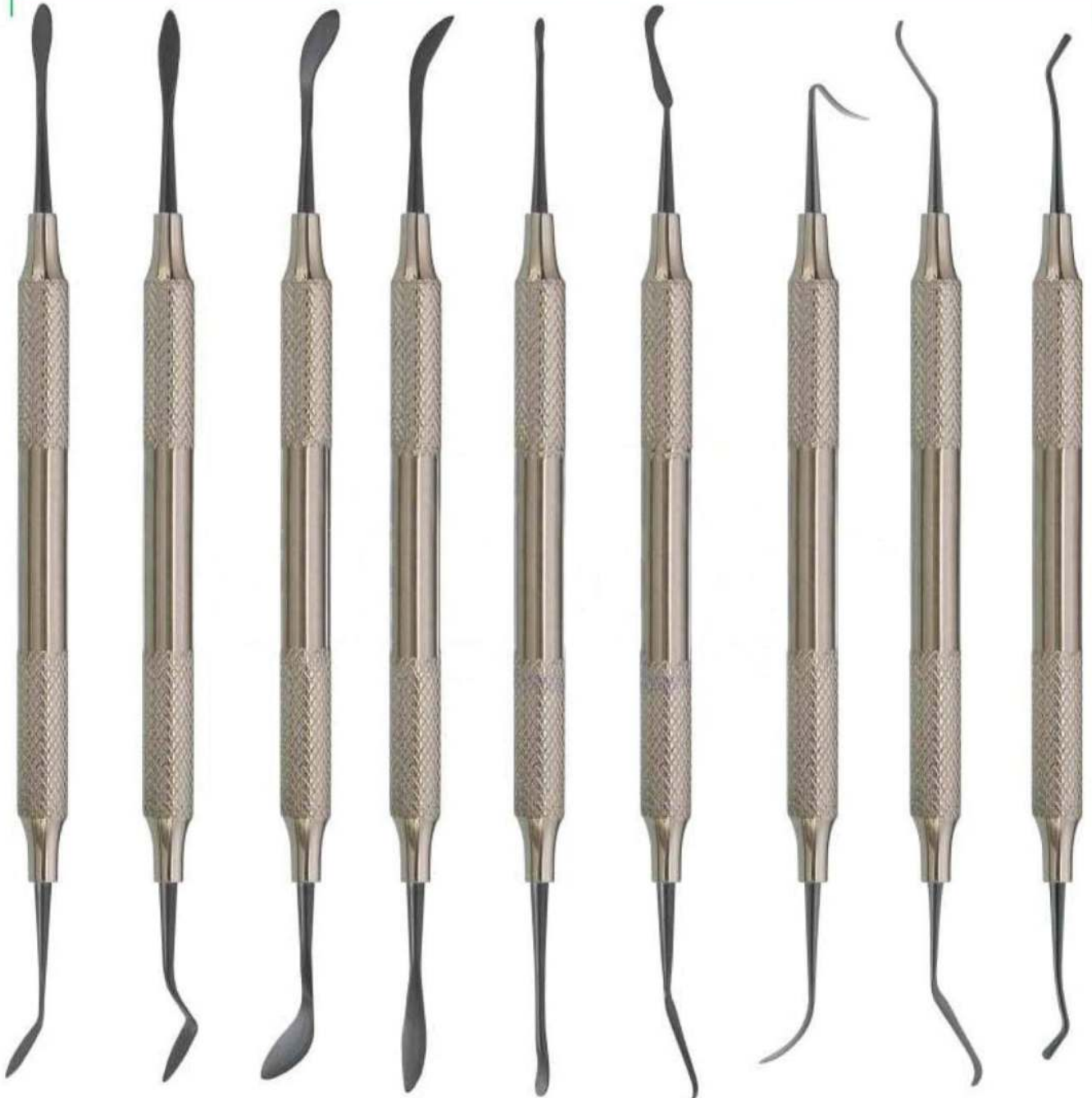

ZI-1482
A
Cosmetic
Contouring

ZI-1483
B
Cosmetic
Contouring

ZI-1484
C
Cosmetic
Contouring

ZI-1485
D
Cosmetic
Contouring

ZI-1486
E
Cosmetic
Contouring

ZI-1487
F
Cosmetic
Contouring

ZI-1488
Marginal Ridge
& Embrasure
Shaping Instrument

ZI-1489
Occlusal
Anatomy
Instrument

ZI-1490
Composite
Packing
Instrument



- Инструменты для имплантологии
- Implantologie
- Implantologie

- Інструменти для імплантології
- Implantologia
- زراعة الأسنان

BLACK TITANIUM COLOUR COATED INSTRUMENTS

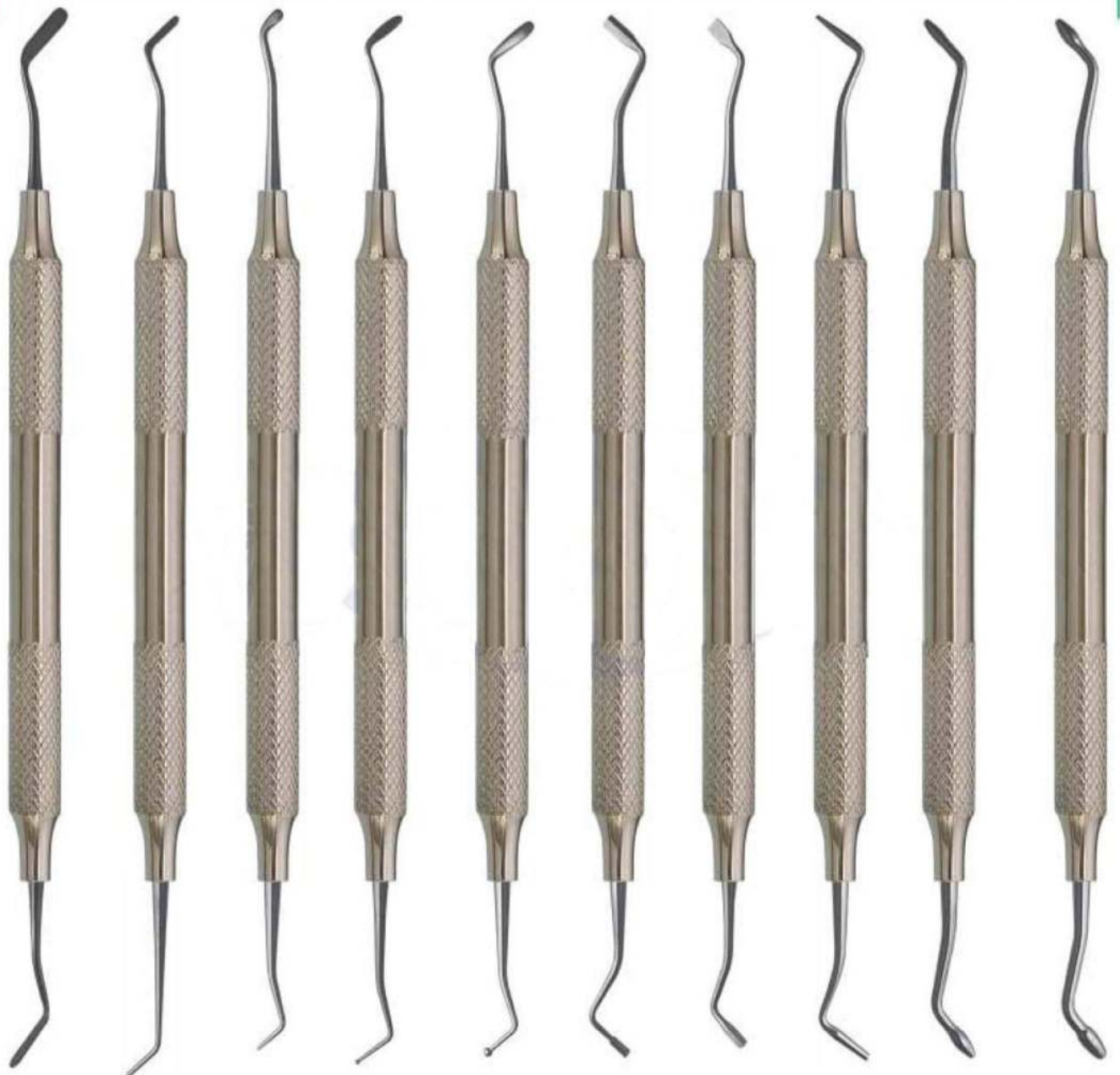
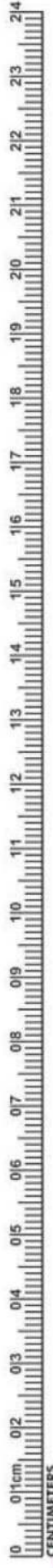

ZI-1491 #3 Extra-Flex	ZI-1492 Mini 1	ZI-1493 Micro-Mini	ZI-1494 Medium Placing/ Condensing	ZI-1495 Large Placing/ Condensing	ZI-1496 OT Tanner	ZI-1497 3 Hollenback	ZI-1498 5A	ZI-1499 Small/Medium Contact Forming	ZI-1500 Medium/Large Contact Forming
-----------------------------	-------------------	-----------------------	---	--	-------------------------	----------------------------	---------------	---	---

IMPLANTOLOGY

- Инструменты для имплантологии
- Instrumente für Implantologie
- Implantologie
- Implantsologie
- زراعة الأسنان

SINUS LIFT INSTRUMENTS HOLLOW HANDLE 9.5MM LENGTH 170MM

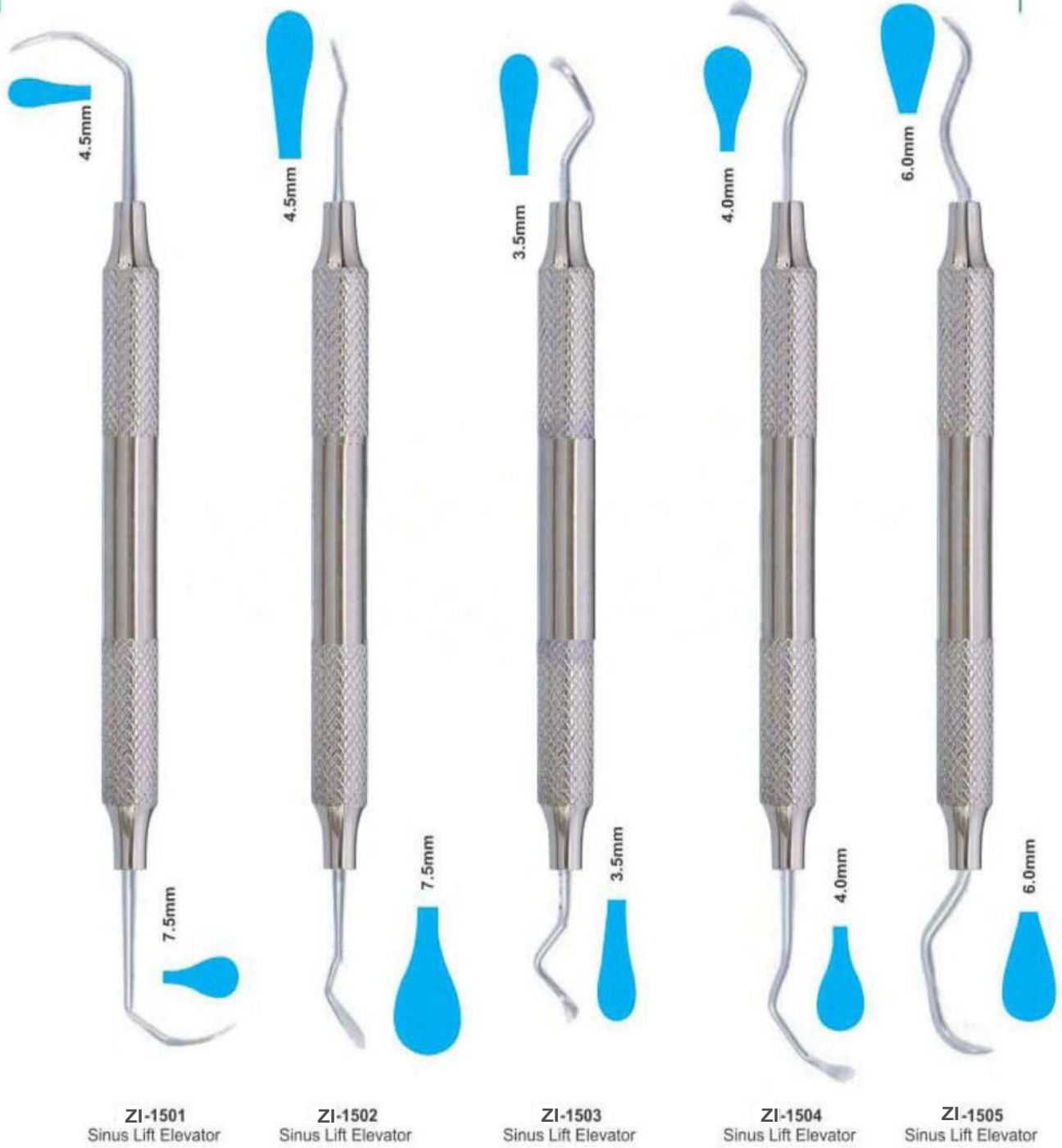

ZI-1501
Sinus Lift Elevator

ZI-1502
Sinus Lift Elevator

ZI-1503
Sinus Lift Elevator

ZI-1504
Sinus Lift Elevator

ZI-1505
Sinus Lift Elevator

INCHES
0 1 2 3 4 5 6 7 8 9

- Инструменты для имплантологии
- Implantologie
- Implantologie
- زراعة الأسنان
- Инструменти для имплантології
- Implantologia
- زراعة الأسنان

SINUS LIFT INSTRUMENTS HOLLOW HANDLE 9.5MM LENGTH 170MM



ZI-1506
Sinus Lift Elevator

ZI-1507
Sinus Lift Elevator

ZI-1508
Sinus Lift Elevator

ZI-1509
Sinus Lift Elevator

IMPLANTOLOGY

- Инструменты для имплантологии
- Implantologie
- Implantologie
- Инструменти для імплантології
- Implantologia
- زراعة الأسنان

IMPLANT SINUS LIFT INSTRUMENTS HOLLOW HANDLE 9.5MM LENGTH 170MM

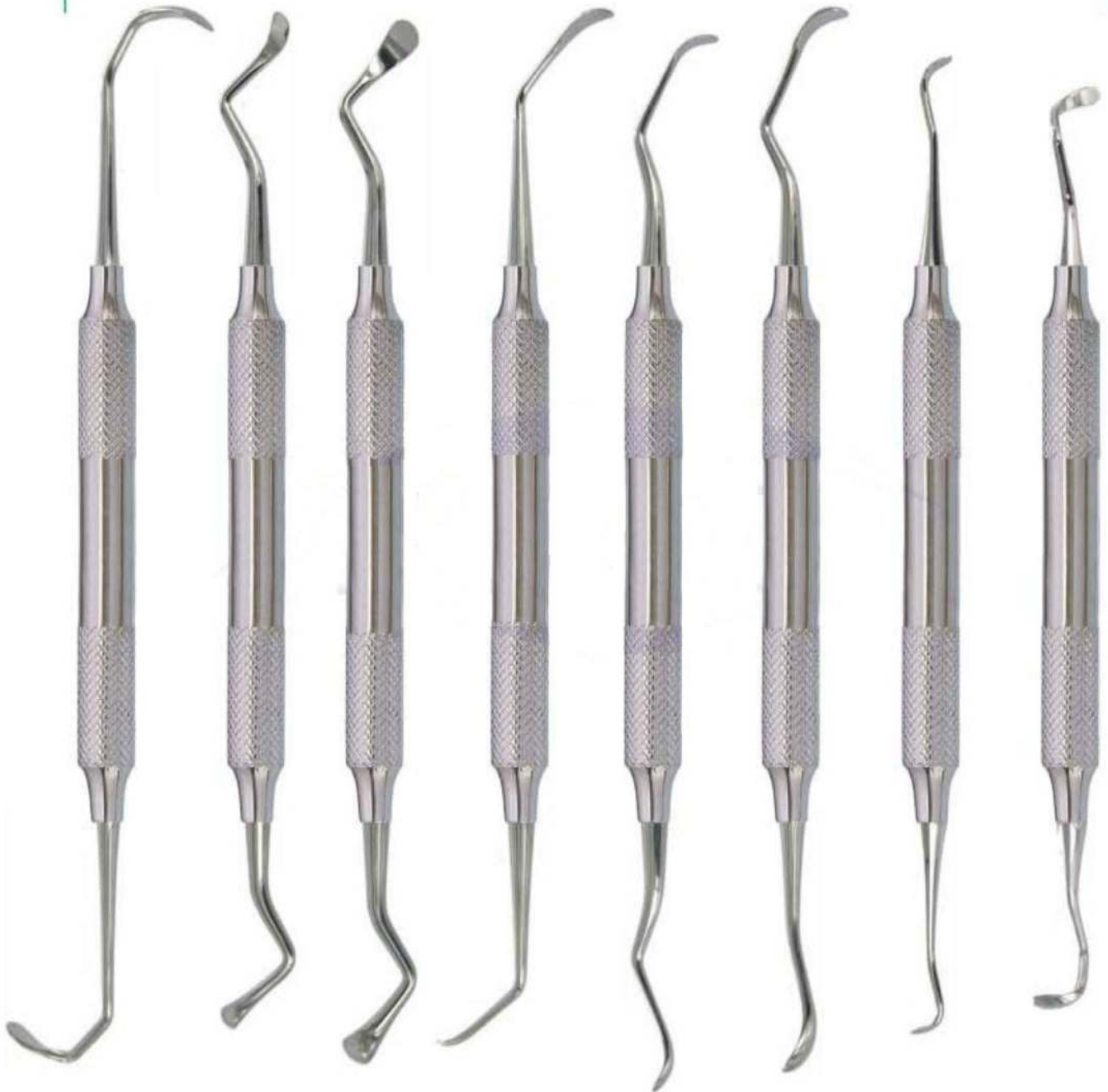

ZI-1510
Acute 6577

ZI-1511
Sinus1

ZI-1512
Sinus2

ZI-1513
Sinus3,
Obtuse 6578

ZI-1514
Sinus4

ZI-1515
Sinus5

ZI-1516
Sinus6

ZI-1517
Sinus7



INCHES

- Инструменты для имплантологии
- Implantologie
- Implantologie
- Инструменти для імплантології
- Implantologia
- زراعة الأسنان

SINUS LIFT INSTRUMENTS HOLLOW HANDLE 9.5MM LENGTH 170MM

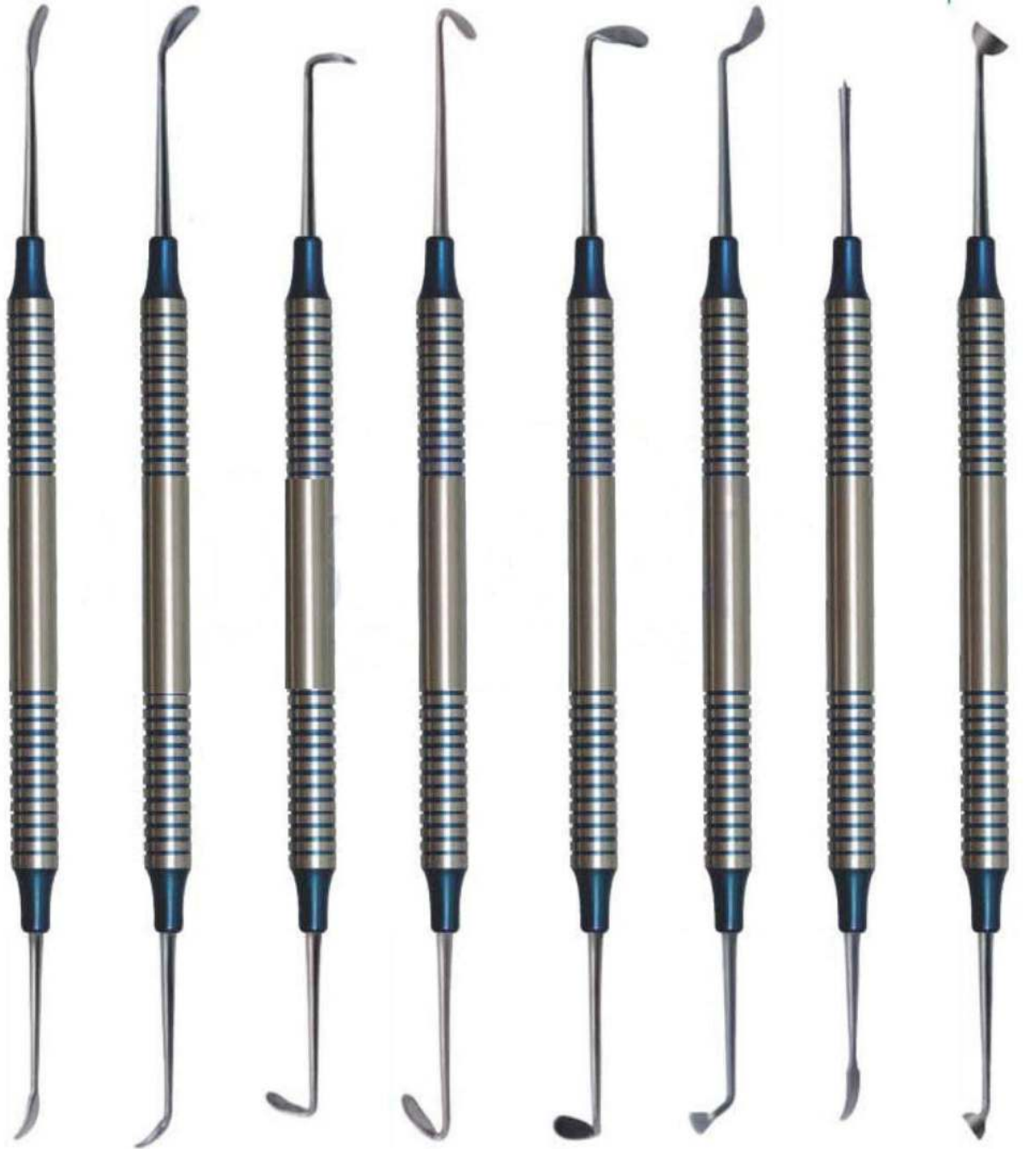
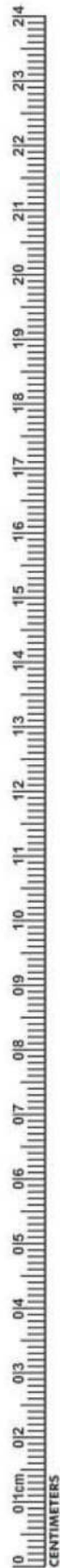

ZI-1518 Sinuslift 1
ZI-1519 Sinuslift 2
ZI-1520 Sinuslift 3
ZI-1521 Sinuslift 4
ZI-1522 Sinuslift 5
ZI-1523 Sinuslift 6
ZI-1524 Membrane 3Positioning 1
ZI-1525 Condenser 1

IMPLANTOLOGY

- Инструменты для имплантологии
- Implantologie
- Implantologie

- Инструменти для имплантології
- Implantoloia
- زراعة الأسنان

Sinus Lift Instrument,
Flexible Sinus Lift instruments
reduce the risk of perforation of the
"Schneider's membrane"



ZI-1526
Fig. 1

ZI-1527
Fig. 2

ZI-1528
Fig. 3

Sinus Lift Elevator,
10 mm Straight grip
Length 175 mm, Sinus lift elevators, dull,
for gentle peeling and lifting the
Schneider membrane



ZII-1529
Fig. 1

ZI-1530
Fig. 2

ZI-1531
Fig. 3

Sinus lift instrument
10 mm Straight grip Length 180 mm,
Buser (B1, B2, B3) raspatories,
quality medical stainless steel,
corrosion-resistant



ZII-1532
B01

ZII-1533
B02

ZII-1534
B03



INCHES

- Инструменты для имплантологии
- Implantologie
- Implantsologie
- Инструменти для імплантології
- Implantologia
- زراعة الأسنان

Sinus lift instrument 10 mm Straight grip Sinus lift elevators, blunt or sharply curved
(H01, H02, K03, K04, K78, K77)

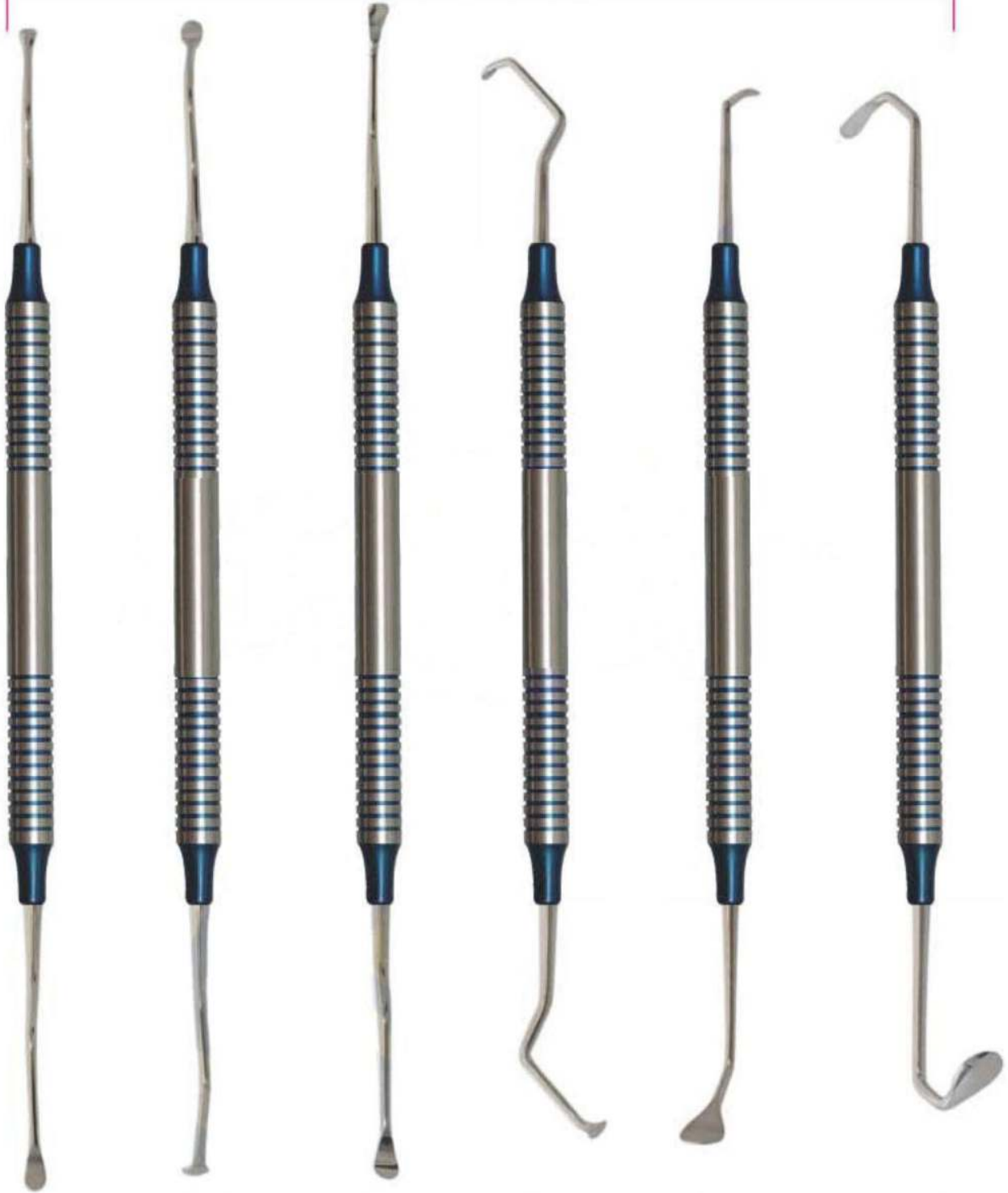

ZI-1535
Sinus lift instrument
H01

ZI-1536
Sinus lift instrument
H02

ZI-1537
Sinus lift instrument
K03

ZI-1538
Sinus lift instrument
K04

ZI-1539
Sinus lift instrument
K78

ZI-1540
Sinus lift instrument
K77

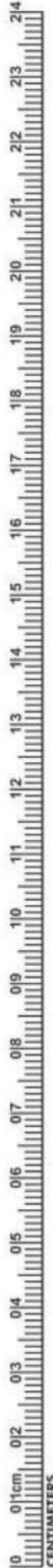

IMPLANTOLOGY

- Инструменты для имплантологии
- Implantologie
- Implantologie
- Инструменти для имплантології
- Implantologia
- زراعة الأسنان

SINUS LIFT INSTRUMENT

Sinus Lift Elevators, 10 mm Hollow Handle length 170mm Blunt Curved Set of 6 Pcs

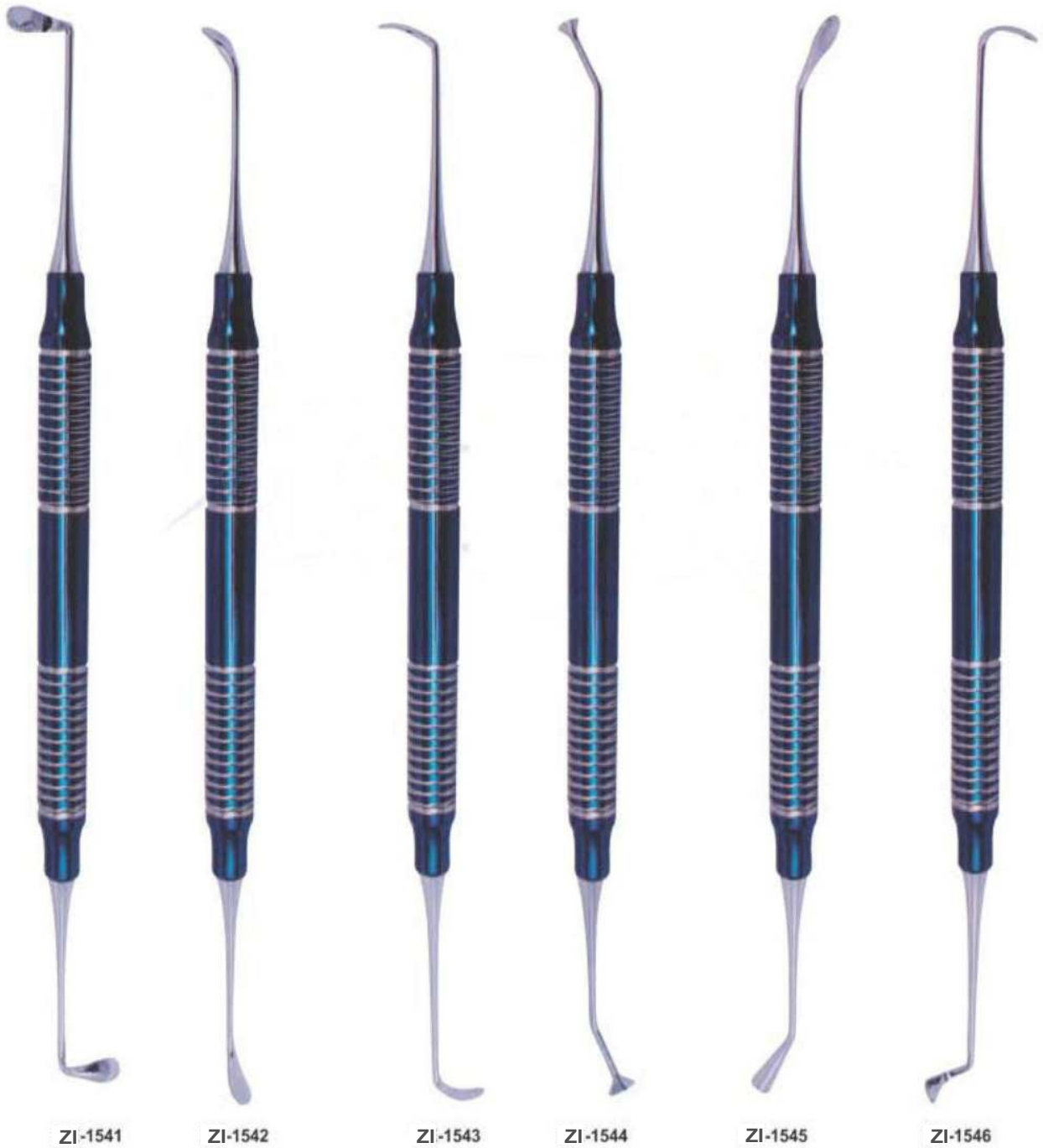

ZI-1541

ZI-1542

ZI-1543

ZI-1544

ZI-1545

ZI-1546

INCHES
0
1
2
3
4
5
6
7
8
9

- Инструменты для имплантологии
- Instrumentologie
- Implantologie
- Инструменти для імплантології
- Implantologia
- زراعة الأسنان

IMPLANT SINUS LIFT INSTRUMENTS
PERIODONTAL SURGERY SURGICAL CHISELS
KRAMER NEVINS SINUS LIFT



ZI-1547 TG



ZI-1548 SOLT3/4



ZI-1549 TGO



ZI-1550 29K



ZI-1551 FEDI4



ZI-1552 OCH3



ZI-1553 OCH4



ZI-1554 FEDI1



ZI-1555 FEDI2



ZI-1556 FEDI3



ZI-1557 Gf36

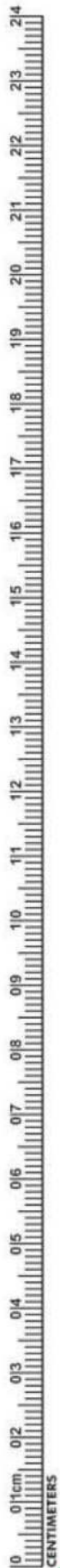

IMPLANTOLOGY

- Инструменты для имплантологии
- Implantologie
- Implantologie

- Инструменти для імплантології
- Implantoloia
- زراعة الأسنان

IMPLANT

SURGICAL CHISELS

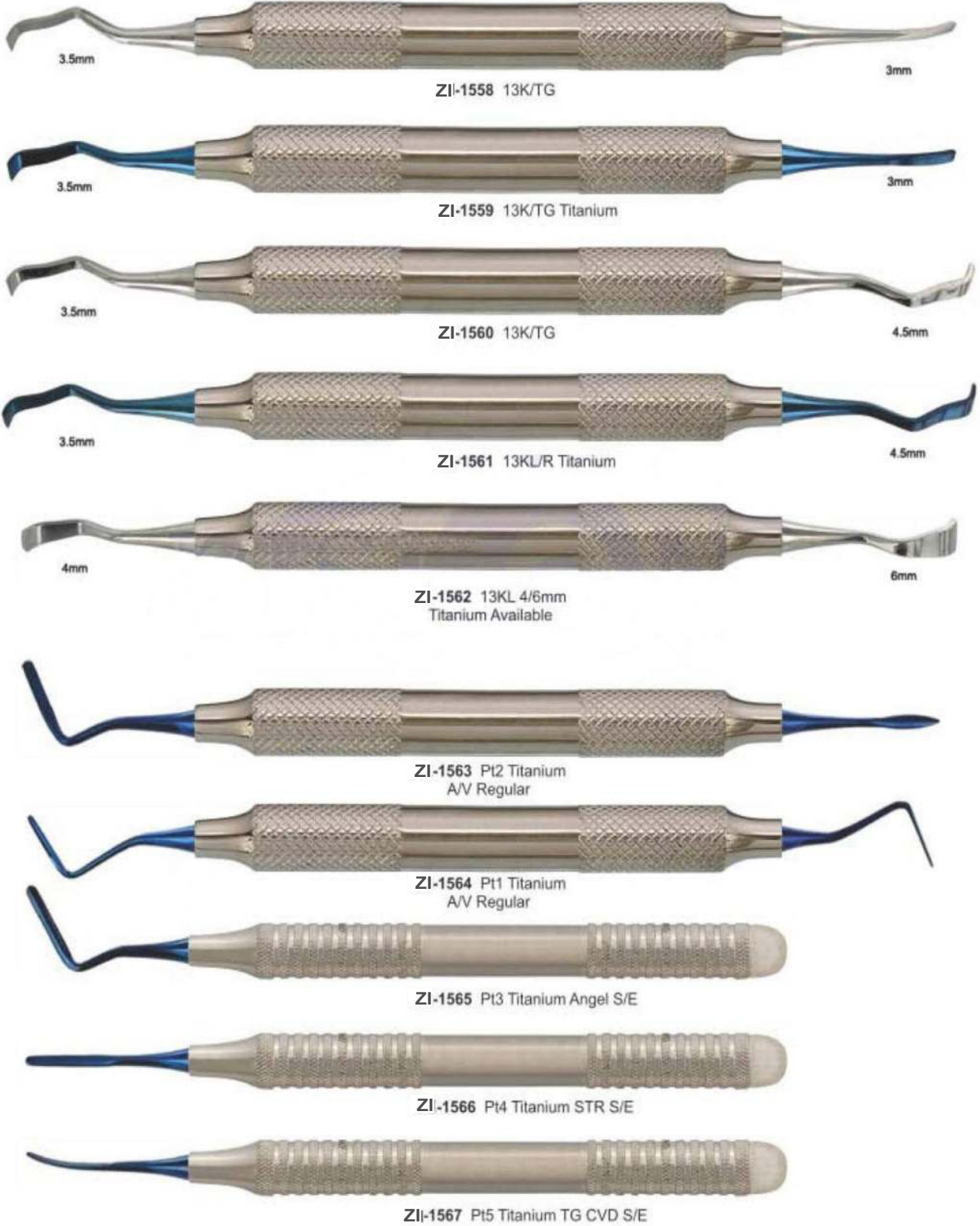

- Инструменты для имплантологии
- Implantologie
- Implantologie

- Інструменти для імплантології
- Implantologia
- زراعة الأسنان

MIXING SPATULA WITH SHOVEL



ZI-1568
Bone Carrier
Titanium



ZI-1569
Raspator, Prichard
Length 180 mm,
10 mm hollow handle,
double-ended
10.5 mm | 4.5 mm,



ZI-1570
Raspator, Prichard
Length 180 mm,
10 mm hollow handle,
double ended



ZI-1571
Raspator, Prichard
Length 180 mm,
10 mm hollow handle,
double-ended
10.5 mm | 4.5 mm,



ZI-1572
Mixing Spatula
with shovel
17cm



ZI-1573
Mixing Spatula
with shovel
18.5cm

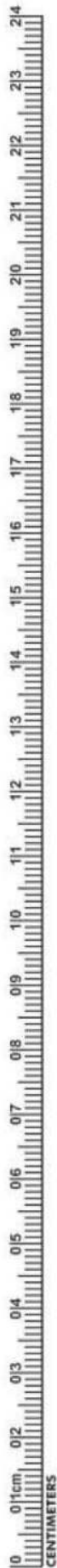

IMPLANTOLOGY

- Инструменты для имплантологии
- Implantologie
- Implantologie
- Инструменти для имплантології
- Implantologia
- زراعة الأسنان

BONE GRAFTING INSTRUMENTS COMPACTOR /TAMPERS

Product offering includes instruments for harvesting, mixing and compacting bone Provides clinicians with the proper instrumentation for bone grafting procedures Weighted bone basin Prevents tipping and spilling of bone and other materials during mixing



ZI-1574
Graft Packer,
Concave Tips
DE 4/6mm

ZI-1575
Bone Spoon/
Packer DE 3mm

ZI-1576
Graft Packer,
Serrated Tips
DE 6/8mm

ZI-1577
Graft Packer,
Serrated Tips
DE 3/4mm

ZI-1578
Graft Packer,
Smooth Tips
DE 5/8mm

ZI-1579
Titanium graft packer/
placement site depth
gauge 3.3mm & 4.0mm
Diameter tips Marked
at 8, 11, 13, 15 & 18mm

ZI-1580
Graft Material Spoon
Concave Tip For
Larger Grafts

INCHES

- Инструменты для имплантологии
- Implantologie
- Implantologie

- Інструменти для імплантології
- Implantologia
- زراعة الأسنان

BONE GRAFTING INSTRUMENTS



ZI-1581
Blade and pusher
Length 180 mm,
for straight or angled,
blade: 15 x 5 mm,
pusher: 4 mm diameter
Straight



ZI-1582
Blade and pusher
Length 180 mm,
for straight or angled,
blade: 15 x 5 mm,
pusher: 4 mm diameter
angular



ZI-1583
Spoon and pusher
Length 180 mm,
for angled spoon:
10 x 5 mm, pusher:
diameter 3 mm



ZI-1584
Tunnelierungs
Instrument
length 175 mm,



ZI-1585
Tunnelierungs
Instrument
length 175 mm,
different designs



ZI-1586
Tamper
Length 170 mm,
for bone material,
double-ended,
diameter 3.2 mm
(2-4-6-8-10) and diameter
2.5mm (2-4-6-8-10)

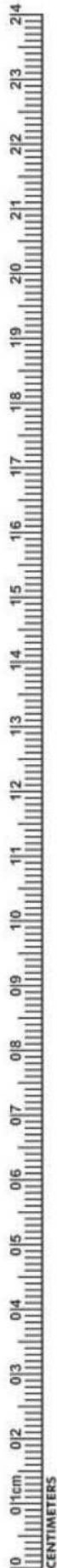

IMPLANTOLOGY

- Инструменты для имплантологии
- Implantologie
- Implantologie
- Инструменти для имплантології
- Implantologia
- زراعة الأسنان

BONE GRAFTING INSTRUMENTS



ZI-1587 Ø 4mm
ZI-1588 Ø 5mm
Compactor
150mm



ZI-1589
Sinus Window
Bone Tampers
4 mm



ZI-1590
Sinus Window
Bone Tampers
7 mm



ZI-1591
6/8mm



ZI-1592
3/4mm

Pluggers Clarizio
Length 160 mm, with titanium tips for mixing and pouring of autologous, heterologous bone substitute material, diameter (3/4 or 6/8 mm)



INCHES

- Инструменты для имплантологии
- Instrumentologie
- Implantologie
- Инструменти для імплантології
- Implantologia
- زراعة الأسنان

SPOON AND PUSHER (TRINOVO)

Trinovo handle, different workers, for bone material, high-grade medical stainless steel, corrosion-resistant

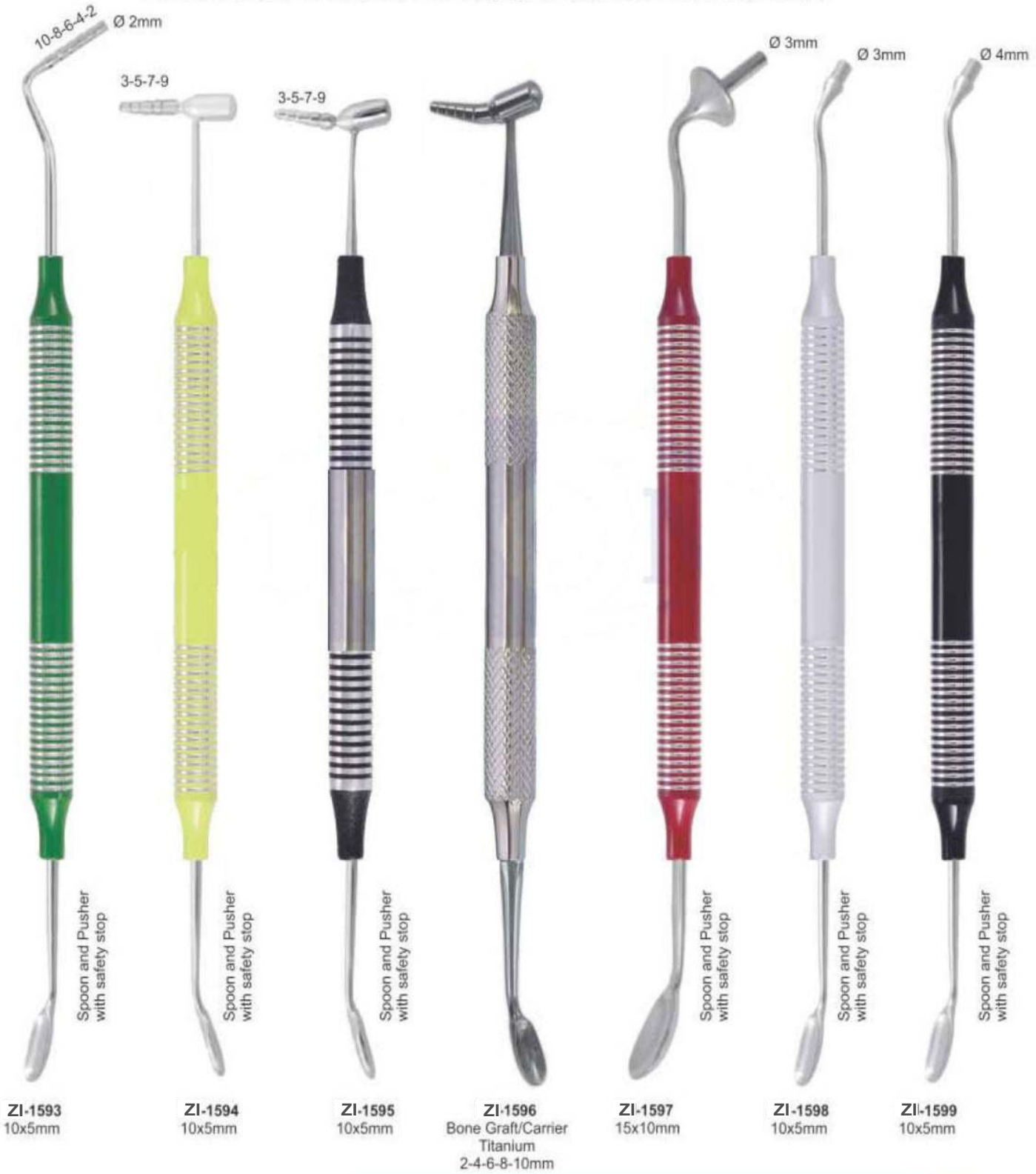
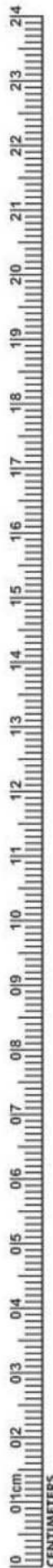

ZI-1593
10x5mm

Spoon and Pusher
with safety stop

ZI-1594
10x5mm

Spoon and Pusher
with safety stop

ZI-1595
10x5mm

Spoon and Pusher
with safety stop

ZI-1596
Bone Graft/Carrier
Titanium
2-4-6-8-10mm

ZI-1597
15x10mm

Spoon and Pusher
with safety stop

ZI-1598
10x5mm

Spoon and Pusher
with safety stop

ZI-1599
10x5mm

Spoon and Pusher
with safety stop

IMPLANTOLOGY

- Инструменты для имплантологии
- Implantologie
- Implantologie
- Инструменти для имплантології
- Implantologia
- زراعة الأسنان

PERIOSTEALS ELEVATOR 10mm Hollow Handle



ZI-1600
Raspator,
BonexScraper
Length 165 mm,
10 mm hollow
handle,
double-ended 6
mm / 4 mm,

ZI-1601
Raspator,
Raspatory
Length 180 mm,
10 mm hollow
handle,
double-ended
3 mm | 3 mm,

ZI-1602
Raspator,
Raspatory
Length 180 mm,
10 mm hollow
handle,
double-ended
3 mm | 3 mm,

ZI-1603
Raspator,
Papilla
Length 185 mm,
10 mm hollow
handle,
double-ended
3 mm | 2 mm,

ZI-1604
Raspator,
bone scraper
Length 175 mm,
10 mm hollow
handle,
double-ended,

ZI-1605
Raspator,
micro-Freer
Length 180 mm,
6 mm solid grip,
double-ended
3 mm | 4 mm

ZI-1606
Raspator,
Freer
Length 180 mm,
6 mm solid
handle,
double-ended
5 mm | 5 mm,



INCHES

- Инструменты для имплантологии
- Implantologie
- Implantologie

- Інструменти для імплантології
- Implantologia
- زراعة الأسنان

PERIOSTEALS ELEVATOR 10mm Hollow Handle

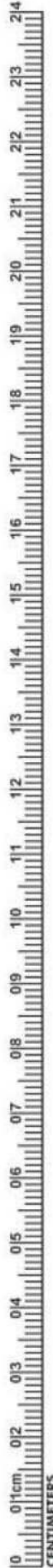

ZI-1607
Raspator, Freer
 10 mm hollow handle, high-quality medical double ended

ZI-1608
Raspator, Molt
 Length 180 mm, 8 mm solid grip, double-ended 6 mm

ZI-1609
Raspator, micro Freer
 Length 185 mm, 10 mm hollow handle, double-ended,

ZI-1610
Raspator, micro Freer
 Length 185 mm, 10 mm hollow handle, double-ended,

ZI-1611
Raspator, micro Raspator / chisel
 Length 170 mm, 10 mm hollow handle, double-ended,

ZI-1612
Raspator, micro Raspator / chisel
 Length 175 mm, 10 mm hollow handle, double-ended,

ZI-1613
Raspator, Micro Raspator / chisel
 Length 175 mm, 8 mm solid handle, double-ended 3.5mm | 3.5 mm,

IMPLANTOLOGY

- Инструменты для имплантологии
- Implantologie
- Implantologie
- Инструменти для имплантології
- Implantoloia
- زراعة الأسنان

PERIOSTEALS ELEVATOR 10mm Hollow Handle



ZI-1614
Raspatory Micro Molt
Length 175 mm,
corrosion-resistant

ZI-1615
Raspatory Chipping
Workers:
Chisel 24G and 7.5 mm,
length about 175 mm,
corrosion-resistant

ZI-1616
Raspatory MOLT
Work ends:
5.0 mm and 4.0 mm,
length about 175 mm,
corrosion-resistant

ZI-1617
Rasp, Molt M9
Length 175 mm,
corrosion-resistant

ZI-1618
Raspator, WAUTIER
Length 175 mm,
corrosion-resistant

ZI-1619
Raspator, BENQUE
Length 170 mm,
workers
5 mm | 7 mm,
corrosion-resistant

ZI-1620
Raspator, Nordberg
Length 180 mm,
8 mm hollow handle,
double-ended
6 mm | 4 mm



IMPLANTOLOGY

- Инструменты для имплантологии
- Implantologie
- Implantologie

- Инструменти для імплантології
- Implantologia
- زراعة الأسنان

Hollow Handle 10mm Length 170mm

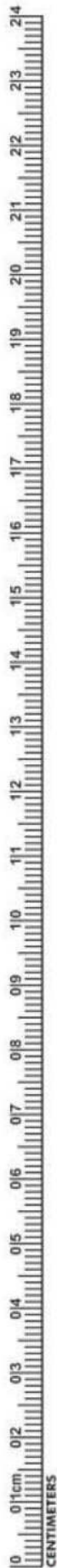

IMPLANTOLOGY

- Инструменты для имплантологии
- Implantologie
- Implantologie

- Инструменти для імплантології
- Implantoloia
- زراعة الأسنان

TISSUE MEMBRANE FORCEPS



ZI-1630
Tissue Graft Forcep
Serrated Teeth



ZI-1631
Self Locking
Grooved



ZI-1632
Tissue Graft Forcep
Serrated Teeth



ZI-1633
Titanium
Locking Plier



ZI-1634
TC Gripper Carbide
Tipped Tissue Forceps
Serrated Carbide Tips
14.5cm



ZI-1635
Adson Carbide
Tipped Tissue Forceps
Serrated Carbide Tips
12cm



ZI-1636
Micor Adson 1x2
Tissue Forcep 12.1cm
1x2 Teeth - 0.5mm Tips



ZI-1637
Adson 7x7
Tissue Forceps
7x7 Teeth 12cm



ZI-1638
Adson 7x7 Curved
Tissue Forceps
7x7 Teeth 12cm



ZI-1639
Suture Pliers
Suture Forceps with
1.6mm Ring Tip



ZI-1640
Debakey Atraumatic
Tissue Forceps Straight
Serrated Teeth
16cm



ZI-1641
Debakey Atraumatic
Tissue Forceps Curved
Serrated Teeth
16cm



INCHES

- Инструменты для имплантологии
- Instrumentologie
- Имплантология
- Инструменти для имплантології
- Implantologia
- زراعة الأسنان

TISSUE MEMBRANE FORCEPS



ZI-1642
Russian Long
Tissue Forceps
Serrated Tip
20cm



ZI-1643
Russian
Tissue Forceps
Serrated Tip
15cm



ZI-1644
Tissue Punch Forceps
To Remove Tissue
After Using Punch



ZI-1645
13.5 cm
narrow



ZI-1646
10.5 cm
Membrane tweezers KUEHNE



ZI-1647
13.5 cm
wide



ZI-1648
Pin-Tweezers
with or without lock,
length 15 cm,
with lock



ZI-1649
without lock,



ZI-1650
Haltepinzette with lock
15,5 cm, for pins, towards
the tips, etc.,



ZI-1651
Carry Forceps
15cm



ZI-1652
Carry Forceps
15cm



ZI-1653
Carry Forceps
15cm

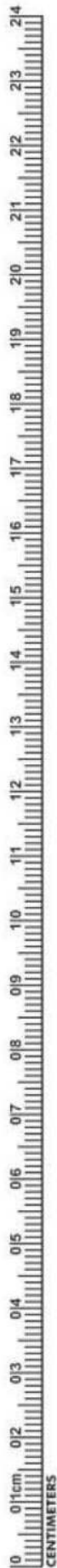

IMPLANTOLOGY

- Инструменты для имплантологии
- Implantologie
- Implantologie
- Инструменти для імплантології
- Implantoloia
- زراعة الأسنان

OSTEOTOME CONVEXES / CONCAVE / CONIQUES

CONVEXES



ZI-1654
SET OF 5 PIECES

CONCAVES



ZI-1655
SET OF 5 PIECES

CONIQUES



ZI-1656
SET OF 5 PIECES

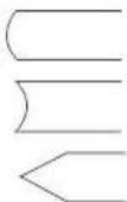
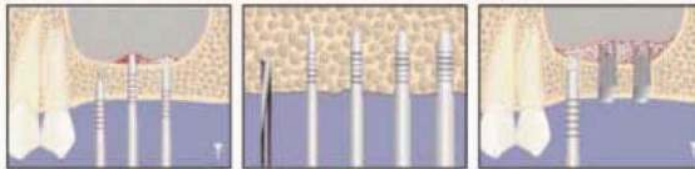

CONVEXES STRAIGHT	ZI-1654	2,7 Ømm	3,2 Ømm	3,7 Ømm	4,2 Ømm	5 Ømm
CONCAVES STRAIGHT	ZI-1655	2,7 Ømm	3,2 Ømm	3,7 Ømm	4,2 Ømm	5 Ømm
CONIQUES STRAIGHT	ZI-1656	2,7 Ømm	3,2 Ømm	3,7 Ømm	4,2 Ømm	5 Ømm



- Инструменты для имплантологии
- Implantologie
- Implantologie
- Инструменти для имплантології
- Implantologia
- زراعة الأسنان

OSTEOTOME CONVEXES / CONCAVE / CONIQUES

CONVEXES



ZI-1657
SET OF 5 PIECES

CONCAVES



ZI-1658
SET OF 5 PIECES

CONIQUES



ZI-1659
SET OF 5 PIECES

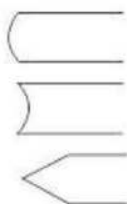
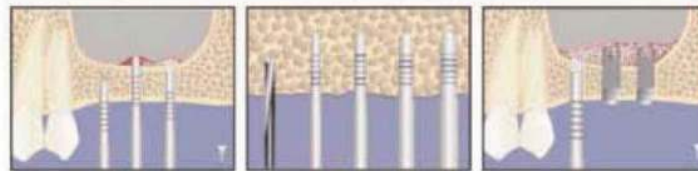

CONVEXES CURVED	ZI-1657	2,7 Ømm	3,2 Ømm	3,7 Ømm	4,2 Ømm	5 Ømm
CONCAVES CURVED	ZI-1658	2,7 Ømm	3,2 Ømm	3,7 Ømm	4,2 Ømm	5 Ømm
CONIQUES CURVED	ZI-1659	2,7 Ømm	3,2 Ømm	3,7 Ømm	4,2 Ømm	5 Ømm

10 0,1cm, 0,2 0,3 0,4 0,5 0,6 0,7 0,8 0,9 1,0 1,1 1,2 1,3 1,4 1,5 1,6 1,7 1,8 1,9 2,0 2,1 2,2 2,3 2,4
CENTIMETERS

IMPLANTOLOGY

- Инструменты для имплантологии
- Implantologie
- Implantologie

- Инструменти для имплантології
- Implantologia
- زراعة الأسنان

TREPINE

Burs with depth markings are suited for precise and simple transplantation of cylindrical bone grafts as well as for all other bone-extraction tasks.



ZI-1669
Tissue Punch with pin
Set of Four Pieces



ZI-1670
Tissue Punch
Set of Five Pieces



ZI-1671
Tissue Punch
Set of Five Pieces



ZI-1672
Trephine Drill
Set of Eight Pieces



ZI-1673
Short Implant Drills

ZI-1674
Long Implant Drills



ZI-1675
Trephine Drill
Set of Eight Pieces



- Инструменты для имплантологии
- Implantologie
- Implantologie
- Инструменти для імплантології
- Implantologia
- زراعة الأسنان

BONE SCRAPER STRAIGHT & CURVED



ZI-1676
Bone Scraper
Straight

ZI-1677
Bone Scraper
Curved

TISSUE PUNCH STRAIGHT & CURVED



ZI-1679
2.0mm

ZI-1681
5.0mm

ZI-1683
7.0mm

ZI-1680
4.0mm

ZI-1682
6.0mm

ZI-1684
8.0mm



ZI-1685
Tissue Punch
Curved

ZI-1686
2.0mm

ZI-1688
5.0mm

ZI-1690
7.0mm

ZI-1687
4.0mm

ZI-1689
6.0mm

ZI-1691
8.0mm



ZI-1692
Bone Mill



ZI-1693
Basins For Bone



BONE CRUSHER
ZI-1694

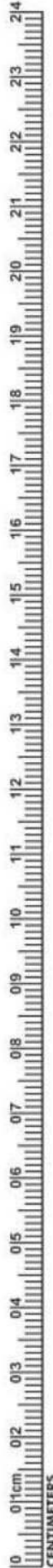

CENTIMETERS

IMPLANTOLOGY

- Инструменты для имплантологии
- Implantologie
- Implantologie
- Инструменти для імплантології
- Implantologia
- زراعة الأسنان

KEYS FOR IMPLANT SCREW



BSI-1695



BSI-1696



BSI-1697



BSI-1698

TORQUE WRENCH & RATCHET



ZI-1699 Star Torque Wrench 6.35mm Universal



ZI-1700 Round Torque Wrench 4.0mm Universal



ZI-1701 Hex Driver With 4.0mm Driver



ZI-1702 Star Torque Wrench 6.35mm Universal



ZI-1703 Hex Torque Wrench 4.00mm Universal



ZI-1704 Star Torque Wrench 6.35mm Universal



ZI-1705 Star Torque Wrench 6.35mm Universal



ZI-1706 Star Torque Wrench 6.35mm Universal



ZI-1707 Star Torque Wrench 6.35mm Universal



ZI-1708 Star Torque Wrench 6.35mm Universal



ZI-1709 Star Ratchet Wrench 6.35mm Universal



ZI-1710 Star Ratchet Wrench 6.35mm Universal



ZI-1711 Star Ratchet Wrench 6.35mm Universal



ZI-1712 Star Ratchet Wrench 4.0mm Universal



ZI-1713 Round Ratchet Wrench 4.0mm Universal



ZI-1714 Round Ratchet Wrench 3.35mm Universal



ZI-1715 Star Ratchet Wrench 4.0mm Universal



ZI-1716 Star Ratchet Wrench 6.35mm Universal



INCHES

- Инструменты для имплантологии
- Implantologie
- Implantologie
- Инструменти для імплантології
- Implantologia
- زراعة الأسنان

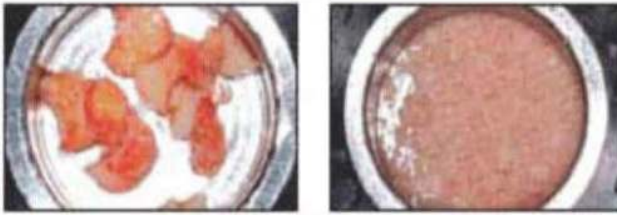

ZII-1717
BONE CRUSHER
Titanium Metal Cutter

mallet



ZII-1718
BONE CRUSHER
Titanium Metal Cutter

mallet



ZII-1719
BONE CRUSHER



ZII-1720
BONE CRUSHER
Bone Grinding Grain
1.5mm, 2mm, 2.5mm



ZII-1721
BONE CRUSHER
Bone Grinding Grain
1.5mm, 2mm, 2.5mm

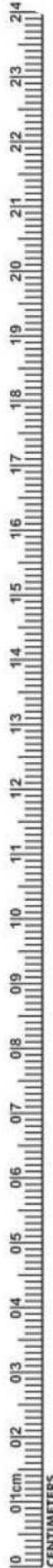

CENTIMETERS

IMPLANTOLOGY

- Инструменты для имплантологии
- Implantologie
- Implantologie

- Инструменти для имплантології
- Implantoloia
- زراعة الأسنان

BONE EXPANDER SCREW & SURGICAL KITS



ZI-1722
 Bone Universal Kit
 Drill: 2mm, 2.8mm, 3.2mm, 3.65mm,
 4.2mm, 4.5mm, 4.8mm, 5.2mm
 Trephines Bit:
 3.0mm, 4.0mm, 5.0mm, 6.0mm,
 7.0mm, 8.0mm, 9.0mm, 10mm.
 Driver:
 2.5mm, 2.5mm Hand Pcs
 1.25mm, 1.25mm Hand Pcs
 Short Driver 2.5mm
 Long Driver 2.5mm
 1.25mm, Short Hex Driver Hand Pcs
 1.25mm, Long Hex Driver Hand Pcs
 Torque Wrench 4.0mm



ZI-1723
 Bone Expander Kit
 Expander: 2.6mm, 3.0mm,
 3.4mm, 3.8mm, 4.3mm
 Ratchet Driver
 Parallel Pin
 Pilot Drill
 Drill 1.4mm
 Drill Driver 4mm
 Hand Driver 4mm
 Ratchet 4.0mm



ZI-1724
 Bone Universal Kit
 Drill: 2mm, 2.8mm, 3.2mm, 3.65mm,
 4.2mm, 4.5mm, 4.8mm, 5.2mm
 Trephines Bit:
 3.0mm, 4.0mm, 5.0mm, 6.0mm,
 7.0mm, 8.0mm, 9.0mm, 10mm.

Bone Compression:
 2mm, 3.3mm, 2.8mm, 4.2mm, 3mm, 3.5mm
 Driver:
 2.5mm, 2.5mm Hand Pcs
 1.25mm, 1.25mm Hand Pcs
 Short Driver 2.5mm
 Long Driver 2.5mm
 1.25mm, Short Hex Driver Hand Pcs
 1.25mm, Long Hex Driver Hand Pcs
 Torque Wrench 6.35mm 1 Pcs



ZI-1725
 Conical Drills: 20 Pcs
 Tissue Punches:
 3.0mm, 3.50mm, 4.0mm, 4.5mm,
 5.0mm, 6.0mm, 6.50mm
 Bone Expander:
 1.6/3.8mm, 1.9/3.0mm, 2.1/3.6mm,
 2.6/3.8mm, 2.9/4.3mm
 Drill Adapter: 1 Pcs
 1.25mm, 2.50mm Hex Driver Hand Pcs

Pilot Drill: 1.6mm
 Drill Bit: 1.4mm, 1.6mm, 1.8mm, 2.0mm, 2.2mm
 Ratchet Driver: 4mm/6.35, 1.25/2.50
 Rimer: 3.2/4.7mm, 3.7/4.7mm
 Parallel Pin: 4.5mm, 2.5mm
 Double step Drill: 2.4/2.8mm
 Depth Gauge: 1 Pcs
 Torque Wrench 6.35mm Universal: 1 Pcs



- Инструменты для имплантологии
- Implantologie
- Implantologie
- Инструменти для імплантології
- Implantologia
- زراعة الأسنان

BONE INJECTORS, COLLECTORS & SUCTION TUBE



ZI-1726
Ø 2,5mm / 3,5mm
170mm

ZI-1727
Ø 4,5mm / 5,5mm
170mm

ZI-1728
Ø 3,5mm / 4,5mm
170mm

ZI-1729
Ø 6,0mm / 7,0mm
170mm



ZI-1730
18cm
Straight / Bend
I.D 2.5mm
O.D 3.5

ZI-1731
18cm
Straight / Bend
I.D 3.5mm
O.D 4.5

ZI-1732
18cm
Straight / Bend
I.D 4.5mm
O.D 5.5

ZI-1733
18cm
Straight / Bend
I.D 6.0mm
O.D 7.0



ZI-1734
17.5cm

ZI-1735
18cm

ZI-1736
coarse
Ø 5mm

ZI-1737
fine
Ø 9mm

Suction tubes to collect the extracted bone material 180mm



ZI-1738
Suction Tubes
180mm

ZI-1739
Suction Tubes
180mm

ZI-1740
Suction Tubes
180mm



ZI-1742
Ø 3 mm
length 180mm

ZI-1743
Ø 4 mm
length 180mm

ZI-1744
Ø 5 mm
length 180mm

ZI-1741
Fig. 6FR
Frazier
15 cm - Ø 2 mm

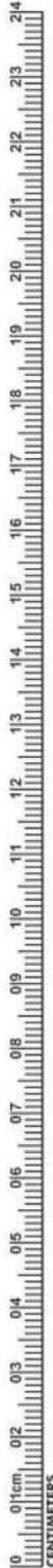

INDEX

DESCRIPTION	PAGE #	DESCRIPTION	PAGE #	DESCRIPTION	PAGE #
3 PRONG CLASP ADJUSTABLE PLIER TC.....	107	CARVERS FILLING INSTRUMENTS.....	69	FLAT NOSE PLIER WITH SERRATION.....	105
ACORN FILLING INSTRUMENTS.....	52	CARVERS INSTRUMENTS.....	73	FLOHR ROOT ELEVATORS.....	20
ADAM PLIER WITH TC.....	102	CARVERS.....	71	FLUCH-CUT DISTAL AND CUTTING PLIERS.....	100
ADAMS PLIER ROUND BOX.....	100	CASTROVIEJO NEEDLE HOLDERS.....	86	FOERSTER DRESSING FORCEPS.....	148
ADAMS PLIERS FOR BENDING WIRE.....	99	CASTROVIEJO SCISSORS.....	84	FORCEP JAR.....	148
ADAMS, SMALL WIRE BENDING AND LOOP FORMING PLIERS.....	100	CEMENT SPATULAS.....	75	FREEDMAN "DUCKHEAD" IMPLANTOLOGY INSTRUMENTS.....	112
ADERER FACEBOW LOOP FORMING PLIERS.....	101	CHEEK RETRACTOR LONG.....	80	FREEDMAN BURNISHERS IMPLANTOLOGY INSTRUMENTS.....	112
ADERER LARGE WIRE BENDING AND LOOP FORMING PLIERS.....	100	CHEEK RETRACTOR.....	80	FREER PERIOSTEEL ELEVATORS.....	95
ADERER PLIER.....	101	CHEEK RETRACTORS, MINNESOTA.....	80	FRIEDMAN BONE ROUNGER.....	14
ADSON BROWN TWEEZERS.....	32	CHEEK RETRACTORS, RETRACTOR IVORY.....	80	FRIEDMANN ROOTS ELEVATOR.....	21
ADSON CARBIDE TIPPED TISSUE FORCEPS.....	133	CHEEK RETRACTORS, TONGUE DEPRESSORS.....	80	GAUGE FOR MEASURING.....	109
ADSON NEEDLE HOLDERS.....	86	CHISELS HOES FILLING INSTRUMENTS.....	74	GERALD TWEEZERS.....	31
ADSON TWEEZERS.....	32	CLAMP, OSTEOMETER.....	109	GILLES TWEEZERS.....	31
ADSON-TC TWEEZERS.....	32	CLAPPISON/FRAHAM RESTORATIVE INSTRUMENTS.....	70	GILLIES NEEDLE HOLDER WITH SCISSORS.....	36
ALLEN PERIOSTEEL ELEVATORS.....	95	CLAW-LIFT ROOTS ELEVATOR.....	22	GOLDMAN FOX EXPLORERS.....	36
ALLIS 4-5 HAEMOSTATIC FORCEPS.....	87	COHEN UNIVERSAL FORCEPS.....	10-11	GOLDMAN FOX MERRIT B EXPLORERS.....	36
ALLIS-BABY 3-4 HAEMOSTATIC FORCEPS.....	87	COLLEGE CURVED.....	32	GOLDMAN FOX UNIVERSITY OF MICHIGAN EXPLORERS.....	36
AMALGAM CARVERS.....	56-57, 70-71	COLLEGE TWEezer.....	32	GOLDMAN FOX WILLIAMS EXPLORERS.....	36
AMALGAM FILES.....	71	COLLEGE WITH LOCK TWEEZERS.....	31	GOLDMAN PERIODONTAL INSTRUMENTS.....	58
AMALGAM INSTRUMENTS & SCALPEL HANDLES.....	92	COLLINS TONGUE FORCEPS.....	31	GOLDMAN-FOX PERIOSTEEL ELEVATORS.....	95
AMALGAM INSTRUMENTS.....	93	COMPOSITE/PLASTIC FILLING INSTRUMENTS.....	49-50, 54	GOLDMAN-FOX SCISSORS.....	83-84
AMALGAM WELL MATRIX RETAINERS.....	91	CONDENSER INSTRUMENTS.....	118	GOLDMAN-FOX SET.....	61
AMALGAM WELL.....	93	CONDENSER MORTONSON FILLING INSTRUMENTS.....	50	GOLDSTEIN INTERPROXIMAL EXCAVATOR.....	67
ANATOMICAL CARVER.....	71	CONTOURING INSTRUMENTS.....	111	GRACEY AFTER FIVE.....	42
ANDREW RESTORATIVE INSTRUMENTS.....	70	CONTOURING PLIER.....	101	GRACEY CURETTE INSTRUMENTS.....	62
ANGLE FORMERS.....	72	COSMETIC CONTOURING.....	113	GRACEY CURETTE SET CASSETTES.....	147
ANGLED DIRECT BOND BRACKET REMOVER TC.....	106	COTTON HOLDER.....	148	GRACEY CURETTE.....	43
ANISWORTH CLAMPS FORCEPS.....	88	COUPLAND ROOT ELEVATORS.....	17	GRACEY MINI FIVE.....	42
ANTERIOR FILLING INSTRUMENTS.....	68	COUPLAND ROOT ELEVATORS.....	18	GRACEY PERIODONTAL INSTRUMENTS.....	39
ANTERIOR.....	47	CRANE KAPLAN TWEEZERS.....	32	GRACEY SET OF 7 PCS.....	40-41
APEXO ROOT ELEVATORS.....	15-19	CRANE-KAPLAN PERIODONTAL INSTRUMENTS.....	59	GRAFT PACKER, CONCAVE TIPS.....	125
APICAL ROOT ELEVATORS.....	19	CRILE NEEDLE HOLDERS.....	85	GREGG IMPLANTOLOGY INSTRUMENTS.....	111
ARCH FORMING PLIERS.....	104	CRILE-WOOD NEEDLE HOLDERS.....	85-86	GRITMAN CEMENT SPATULAS.....	75
ARTICULATORS.....	77	CROWN AND BAND CONTOURING PLIERS.....	105	GROSS MAIER DRESSING FORCEPS.....	111
A-TRAUMATIC EXTRACTION SET.....	03	CROWN REMOVER.....	90	GUM SCISSORS.....	111
ATRAUMATIC TWEEZERS.....	31	CROWN SPREADERS.....	90	HAEMOSTATIC FORCEPS & TOWEL CLAMPS.....	87
BACK ACTION FILLING INSTRUMENTS.....	52	CRUYER EXTRACTING FORCEPS.....	10	HALSEY NEEDLE HOLDERS.....	85-86
BACKHAUS HAEMOSTATIC FORCEPS.....	87	CRUYER ROOTS ELEVATOR.....	23	HALSTEAD MOSQUITO HAEMOSTATIC FORCEPS.....	87
BACOLITE HANDLE WAX KNIVES.....	76	CURETTE COLUMBIA.....	43	HALSTEAD MOSQUITO NEEDLE HOLDERS.....	86
BALDWIN FILLING INSTRUMENTS.....	49	CURETTE INSTRUMENTS.....	63	HALTEPINZETTE WITH LOCK.....	134
BALL FILLING INSTRUMENTS.....	52	CURETTE MCCALL.....	43	HAMMER HEAD TIE BACK PLIER.....	104
BALL HOOK CRIMPING PLIER.....	105	CURETTE.....	60	HANDLES FOR MOUTH MIRRORS.....	30
BAND PUSHER.....	90	CURETTERS SET OF 8 PIECES.....	43	HARD WIRE CUTTERS.....	107
BAND REMOVING PLIER.....	99	CURETTES.....	40-43, 61-62	HARRIS EXTRACTING FORCEPS.....	11
BAND SEATER AUTO CLEAVABLE.....	97	CUTTING INS PERIODONTAL INSTRUMENTS.....	39	HARTMANN (BABY MOSQUITO) NEEDLE HOLDERS.....	86
BAND SEATING PLIER.....	104	DARBY-PERRY EXCAVATORS.....	65	HATCHETS FILLING INSTRUMENTS.....	68
BANDS & CROWNS PL.....	101	DE LA ROSA PLIERS WITH GROOVED.....	105	HEAT CARRIERS.....	46
BASINS FOR BONE.....	138	DE LA ROSA PLIERS.....	105	HEBER ROOTS ELEVATOR.....	24
BAUMGARTER NEEDLE HOLDERS.....	85	DEAN SCISSORS.....	105	HEIDBRINK ROOT ELEVATORS.....	20-21, 26
BAUMGARTNER NEEDLE HOLDERS.....	86	DEBAKEY ATRAUMATIC TISSUE FORCEPS.....	133	HEIDMANN PERIODONTAL INSTRUMENTS.....	39
BAYONET ROOTS ELEVATOR SET.....	21	DEEP BOWL.....	148	HEMINGWAY CURETTE INSTRUMENTS.....	63
BEAVERTAIL FILLING INSTRUMENTS.....	52	DEEP ROOT PICK FORCEPS (APICAL SET OF 9).....	04	HEMINGWAY TWEEZERS.....	32
BEEBEE NEEDLE HOLDERS.....	85	DELICATE NEEDLE HOLDERS.....	96	HOES.....	71
BEIN ROOT ELEVATORS.....	15-16, 24	DELUXE BRACKET HOLDER TWEEZERS.....	96	HOLLANBACK PERIODONTAL INSTRUMENTS.....	39
BEYER BONE ROUNGER.....	14	DENHARD CHEEK RETRACTORS.....	79	HOLLENBACK FILLING INSTRUMENTS.....	50
BINANGLE FILLING INSTRUMENTS.....	74	DENTAL MIRROR PERIODONTAL INSTRUMENTS.....	13	HOLLENBACK IMPLANTOLOGY INSTRUMENTS.....	114
BIRD BEAK ANGLED BENDING PLIER.....	103	DENTAL SYRINGES.....	13	HOLLENBACK RESTORATIVE INSTRUMENTS.....	70
BIRD BEAK PLIER WITH TC.....	102	DERF NEEDLE HOLDERS.....	85	HOLLOW HANDLE.....	132
BIRD BEAK WIRE BENDING & CUTTING PLIERS.....	101	DERF NEEDLE HOLDERS.....	86	HOLLOW WARE.....	148
BIRD BEAK WIRE BENDING PLIER.....	100	DIRECT BOND BRACKET HOLDER TWEEZERS.....	96	HOLLOWCHOP CONTOURING PLIERS.....	106
BIRD BEAK WITH CUTTER PLIERS.....	104	DIRECT BONDING BRACKET HOLDERS.....	96	HOOK CRIMPING PLIER ANGLED STRAIGHT TC.....	107
BLACK FILLING INSTRUMENTS.....	50	DIRECT BONDING BRACKET REMOVER PLIER TC.....	106	HOOK KNIVES.....	76
BLACK TITANIUM COLOUR COATED INSTRUMENTS.....	110-111	DIRECT BRACKET REMOVER TC.....	107	HOW PLIER CURVED WITH TC.....	103
BLADE AND PUSHER.....	126	DISCOID-CLEOID CARVER.....	71	HOW PLIER CURVED.....	99, 104
BLUMENTHAL BONE ROUNGER.....	14	DISTAL END CUTTER REGULAR WITH T.C.....	102	HOW PLIER STRAIGHT WITH TC.....	103
BOGHOSIAN FILLING INSTRUMENTS.....	49	DISTAL END CUTTER, SAFETY HOLD PLIER.....	102	HOW PLIER STRAIGHT.....	103
BOGHOSIAN IMPLANTOLOGY INSTRUMENTS.....	111	(IDEAL FOR CUTTING WIRE) TC.....	107	HOWARD PERIOSTEEL ELEVATORS.....	95
BOLEY GAUGE.....	109	DISTAL END, WIRE CUTTERS & BRACKET REMOVER PLIERS.....	107	HYGIENIST PERIODONTAL INSTRUMENTS.....	58
BONE BRACKET GAUGE.....	96	DOUBLE ENDED CEMENT SPATULA.....	98	HYGIENIST-JACQUETTE PERIODONTAL INSTRUMENTS.....	58
BONE BRACKET TITANIUM.....	124	DRESSING TWEEZERS.....	31-32	HYGIENIST-TOWNER PERIODONTAL INSTRUMENTS.....	58
BONE CRUSHER.....	138, 140	ELASTIC SEPARATING PLIER.....	107	HYLIN CEMENT SPATULAS.....	75
BONE EXPANDER SCREW & SURGICAL KITS.....	141	ELASTOMERIC LIGATURE PLACING FORCEPS.....	107	HYLIN ROOTS ELEVATOR.....	23
BONE FILES.....	94	WITH GROOVE FALCON.....	107	IMPLANT GAGES.....	108
BONE GRAFT/CARRIER TITANIUM.....	128	ELLIOT MATRIX RETAINERS.....	91	IMPLANT SINUS LIFT INSTRUMENTS.....	117, 122
BONE GRAFTING INSTRUMENTS COMPACTOR /TAMPERS.....	125	ENDED CHEEK RETRACTORS.....	79	IMPLANT.....	123
BONE GRAFTING INSTRUMENTS.....	126-127	ENDODONTIC BOX.....	148	IMPLANTOLOGY IMPLANTOLOGY INSTRUMENTS.....	112
BONE INJECTORS, COLLECTORS & SUCTION TUBE.....	142	ENDODONTICS INSTRUMENTS.....	47	IMPLANTOLOGY INSTRUMENTS.....	111
BONE MILL.....	138	ENGLISH PATTERN KLEIN #3 PEDODONTIC UNIVERSAL FORCEPS.....	08	IMPLANTOLOGY.....	108-110
BONE ROUNGER.....	14	EXAMINATION KIT SET OF 3 PIECES.....	34	IMPRESSION TRAYS.....	143-146
BONE SCRAPER STRAIGHT & CURVED.....	138	EXAMINATION SET OF 4 PIECES.....	34	INSTRUMENTS BOX.....	148
BONE SPOON/PACKER.....	125	EXAVATORS.....	37	INSTRUMENTS CASSETTES & STANDS.....	147
BONE THICKNESS GAUGE.....	109	EXCAVATOR PERIODONTAL INSTRUMENTS.....	39	INTERPROXIMAL CARVER IMPLANTOLOGY INSTRUMENTS.....	111
BONE UNIVERSAL KIT.....	149	EXCAVATORS INSTRUMENTS SET OF 11 PIECES.....	57	INTERPROXIMAL OFF-ANGLE FILLING INSTRUMENTS.....	49
BRACKET REMOVER ANGULATED PLIER.....	103	EXCAVATORS INSTRUMENTS.....	64-67	INTRALIGAMENTAL ANESTHESIA SYRINGE.....	13
BRACKET REMOVER PLIER STRAIGHT.....	103	EXCAVATORS.....	64	IRIS SCISSORS.....	83-84
BRACKET REMOVER PLIERS ANGLED WITH T.C.....	102	EXPLORER PERIODONTAL INSTRUMENTS.....	39	IVORY LIGHT WEIGHT CLAMPS FORCEPS.....	88
BRACKET REMOVER PLIERS STRAIGHT WITH T.C.....	102	EXPLORERS INSTRUMENTS.....	35	IVORY MATRIX RETAINERS.....	91
BRACKET REMOVING PLIER ROUND BOX.....	99	EXPLORERS.....	33-45	IWANSON SPRING CALIPER.....	109
BRACKET REMOVING PLIER.....	99	EXTRACTING FORCEPS (AMERICAN PATTERN).....	10-14	JACQUETTE SCALERS PERIODONTAL INSTRUMENTS.....	59
BREWER CLAMPS FORCEPS.....	88	EXTRACTING FORCEPS (ENGLISH PATTERN).....	01-02, 05-07	JARA BEAK PLIER.....	104
BURNISHER FILLING INSTRUMENTS.....	49	EXTRA-FLEX IMPLANTOLOGY INSTRUMENTS.....	114	JENNINGS CHEEK RETRACTORS.....	79
BURNISHER FILLING INSTRUMENTS.....	54	FALCON BEAK CONTOURING PLIERS.....	100	JOHNSON CONTOURING PLIERS.....	100
BURNISHER UNIVERSITY OF MICHIGAN AMALGAM CARVERS.....	54	FARABEUZ RETRACTOR.....	82	JONES HAEMOSTATIC FORCEPS.....	87
BURNISHERS FILLING INSTRUMENTS.....	52-53	FELDMAN RETRACTOR.....	82	JOSEPH SCISSORS.....	84
BURNISHERS IMPLANTOLOGY INSTRUMENTS.....	112	FILES FILLING INSTRUMENTS.....	53	KELLY HAEMOSTATIC FORCEPS.....	87
BUSER PERIOSTEEL ELEVATORS.....	95	FILLING INS PERIODONTAL INSTRUMENTS.....	39	KELLY SCISSORS.....	83-84
CARRY FORCEPS.....	134	FILLING INSTRUMENTS.....	37, 44, 49-55, 69, 72	KELLY-RANKIN HAEMOSTATIC FORCEPS.....	87
CARVER HOLLENBACK AMALGAM CARVERS.....	56	FLAT NOSE PLIER SMOOTH.....	105	KEYS FOR IMPLANT SCREW.....	139





DESCRIPTION	PAGE #	DESCRIPTION	PAGE #	DESCRIPTION	PAGE #
KIDNEY TRAY WITH COVER (ENGLISH PATTERN)	148	ORTHO LIGHT SCALER HEAVY	97	SINUS LIFT INSTRUMENT	118-121
KIDNEY TRAYS	148	ORTHO LIGHT SCALER SINGLE ENDED	98	SINUS LIFT SET STAND	147
KILNER (RAGNELL) SCISSORS	84	ORTHO LIGHT SCALER	97	SINUS WINDOW BONE TAMPERS	127
KLEINERT-KUTZ BONE ROUNGER	14	ORTHODONTIC INSTRUMENTS	96-98	SINUSLIFT INSTRUMENTS	118
KOPP ROOTS ELEVATOR	23-24	ORTHOLITE LIGATURE DIRECTOR SCALER	98	SIOVELAND RETAINERS TOFFLEMIRE-JUNIER MATRIX RETAINERS	91
KRARNER-NEVINS BONE CHISEL	94	OSTEOMETER MEASURING FORCEPS	96	SMAHA ELASTOMERIC LIGATURE PLACING FORCEPS	107
LA GRANGE SCISSORS	83-84	OSTEOTOME CONVEXES / CONCAVE / CONIQUES	135-136	SPENCER SCISSORS	84
LADMORE FILLING INSTRUMENTS	52	OVAL SPOONS/DARBY-PERRY	65	SPIRIT LAMP	148
LADMORE IMPLANTOLOGY INSTRUMENTS	112	P.K. THOMAS WAXING INSTRUMENTS	73	SPOON AND PUSHER (TRINOVO)	128
LAP-JOINT THREE PRONG PLIER	106	PALATAL ARCH PLIER	105	SPOON AND PUSHER WITH SAFETY STOP	128
LAXUTOR ROOT ELEVATORS	19	PALMER CLAMPS FORCEPZ	88	SPOONS	84
LE CRON CEMENT SPATULAS	75	PDL ELEVATORS	28-29	SPREADERS	46
LESSMANN	76	PEDIATRIC TOOTH EXTRACTING FORCEPS SET	09	STANDARD LIGATURE CUTTER TC	106
LIGATURE FORMING PLIERS	101	PERIODONTAL FILLING INSTRUMENTS	53	STEP PLIERS WITH TC	103
LIGHT WIRE BIRD BEAK LONG PLIER WITH TC	102	PERIODONTAL INSTRUMENTS	37, 39, 58, 60, 95	STERILIZING DRUM	148
LIGHT WIRE BIRD BEAK LONG PLIER	104	PERIODONTAL PROBES	46, 48	STOP V BENDING PLIER	105
LIGHT WIRE BIRD BEAK PLIERS	104	PERIOSTEAL ELEVATOR	95, 129-130	STRAIGHT DIRECT BOND BRACKET REMOVER TC	107
LIGHT WIRE CUTTER MICRO WITH TC	102	PERIOTOME ROOTS ELEVATOR	26	SURGICAL CHISELS	123
LIGHT WIRE PLIER	104	PERRY TWEEZER	31-32	SURGICAL TWEEZERS	31
LINDO LEVIAN ROOT ELEVATORS	20	PESTERIOR BEND REMOVER PLIER LONG	103	SUTURE PLIERS SUTURE FORCEPS	133
LINGUAL / PALATAL ARCH FORMING PLIERS	101	PESTERIOR BEND REMOVER PLIER MEDIUM	103	SYNDESMOTOMES ROOTS ELEVATOR	26
LINGUAL PLIER LONG HANDLE	106	PESTERIOR BEND REMOVER PLIER SHORT	103	TAMPER	126
LINGUAL PLIER WEINGART	106	PIN & LIGATURE CUTTERS TC	106	TANNER FILLING INSTRUMENTS	52, 69
LINGUAL WEINGART PLIER	106	PIN HOLDING PLIER TC	107	TANNER IMPLANTOLOGY INSTRUMENTS	114
LINING APPLICATOR DOUBLE END	55	PIN-TWEEZERS	134	TC GRIPPER CARBIDE	133
LOCKLIN SCISSORS	84	PLAIN MIRRORS	30	THARP RESTORATIVE INSTRUMENTS	70
LONDON COLLEGE TWEEZERS	31	PLASTER KNIFE 76 SPECIAL INOX	76	THREE PRONG PLIERS REGULAR	106
LORNA HAEMOSTATIC FORCEPS	87	PLIERS FOR ORTHODONTICS & PROSTHETICS	99-106	TISSUE GRAFT FORCEP SERRATED TEETH	133
LUCAS	132	PLUGGER PERIODONTAL INSTRUMENTS	39	TISSUE MEMBRANE FORCEPS	132, 134
LUER BONE ROUNGER	14	PLUGGER BLACK AMALGAM CARVERS	56	TISSUE PUNCH FORCEPS	134
LUKS	47	PLUGGERS	45, 48	TISSUE PUNCH STRAIGHT & CURVED	138
LUXATOR ROOT ELEVATORS	15-16, 21	PLUGGERS/CONDENSERS FILLING INSTRUMENTS	50	TOFFLEMIRE-SENIOR MATRIX RETAINERS	91
LUXIER ROOTS ELEVATOR	22	PLUGGERS/CONDENSERS	51	TOFFLEMIRE-UNIVERSAL MATRIX RETAINERS	91
MAGNIFYING MIRRORS	30	POINTED CURETTE	60	TORQUE WRENCH & RATCHET	139
MANUAL CROWN REMOVER	90	POINTED PROBES SINGLE ENDED	36	TOWNER PERIODONTAL INSTRUMENTS	58
MARCOTTE LOOPING PLIER	105	POSTERIOR	48	TOWNER-JACQUETTE PERIODONTAL INSTRUMENTS	58
MARGIN TRIMMERS	72	POSTERIOR BAND REMOVER PLIERS	102	TREPINE DRILL SET OF EIGHT PIECES	137
MARGINAL RIDGE & EMBRASURE SHAPING INSTRUMENT	113	POTT ROOTS ELEVATOR	25	TUFTS FILLING INSTRUMENTS	49
MARKLEY PLUGGERS/CONDENSERS	51	POWER CROWN REMOVER LIFT	90	TUNNELIERS INSTRUMENT	126
MARQUETTE FILLING INSTRUMENTS	50	PRICHARD PERIOSTEAL ELEVATORS	95	TWEED / ANGEL FORMING AND TORQUING PLIERS	101
MARYAM TWEEZERS	32	PROBES DOUBLE ENDED	35	TWEED / ANGLE RECTANGULAR ARCH FORMING & TORQUING PLIERS	100
MATHIEU NEEDLE HOLDERS	86	PROBES SINGLE ENDED	34	TWEED ARCH FORMING PLIER TC	102
MATRIX RETAINERS	91	QUETIN FILLING INSTRUMENTS	49	TWEED CUTTER PLIER	104
MAYO NEEDLE HOLDERS	85	RASPATOR, BENQUE	131	TWEED LOOP FORMIN PLIERS	100
MAYO SCISSORS	83	RASPATOR, FREER	129, 131	TWEED LOOP FORMING PLIER TC	105
MAYO-HEGAR NEEDLE HOLDERS	85-86	RASPATOR, MICRO FREER	131	TWEED LOOP FORMING PLIERS	99
MEAD 1A BONE ROUNGER	14	RASPATOR, MICRO RASPATOR / CHISEL	131	TWEED LOOP PLIER	104-105
MEAD BONE FILES	94	RASPATOR, MICRO-FREER	129	TWEezer PERIODONTAL INSTRUMENTS	39
MEASURING LOOP, CASTROVIEJO	109	RASPATOR, NORDBERG	131	TWEEZERS	31
MEASURING LOOP, CASTROVIEJO	109	RASPATOR, PRICHARD	124	TWEEZERS	32
MEDIUM CEMENT CEMENT SPATULAS	75	RASPATOR, RASATORY PERIOSTEAL ELEVATORS	95	TWEL-ON ELASTIC MODULE INSTRUMENT	97
MEDIUM PLACING/CONDENSING IMPLANTOLOGY INSTRUMENTS	114	RASPATOR, WAUTIER	131	UNIVERSAL DOLPHIN STYLE WIRE BENDING & CUTTING PLIERS	99
MEMBRANE POSITIONING INSTRUMENTS	118	RASPATOR, WILLIGER PERIOSTEAL ELEVATORS	95	UNIVERSAL FILLING INSTRUMENTS	49
MEMBRANE TWEEZERS KUEHNE	134	RASPATORY CHIPPING	131	UNIVERSAL FILLING INSTRUMENTS	54
MERIAM TWEEZERS	31	RASPATORY MICRO MOLT	131	UNIVERSAL NEEDLE HOLDERS	85
MERRIT A EXPLORERS	36	RASPATORY MOLT	131	UNIVERSITY OF MICHIGAN EXPLORERS	36
MERRIT B EXPLORERS	36	REGULAR TWEED ARCH FORMING PLIERS	104	UTILITY PLIER WEINGART TC	107
MERSHON CROWN REMOVER	90	RESTORATIVE INSTRUMENTS	51-53, 68, 70-72	V BEND STOP PLIER TC	106
METZENBAUM NEEDLE HOLDERS	85	RETRACTOR WITH ERGO GRIP	90	W. BARRY ROOTS ELEVATOR	25
METZENBAUM SCISSORS	83	RETRACTORS - MOUTH GAGS	78-79	WAHL BONE FILES	94
MICOR ADSON TISSUE FORCEP	133	RETRACTORS	80-82	WALDSAVHS WIRE BENDING AND CUTTING PLIERS	101
MICRO IRIS SCISSORS	83	RETRACTORS CHEEK RETRACTOR COMBINATION COMBINATION	80	WALL FILLING INSTRUMENTS	69
MICRO-FRIEDMAN BONE ROUNGER	14	RETRACTORS COMBINATION	81	WANGEN HOLDER	78
MILLER BONE FILES	94	RETRACTORS, LANGENBECK	82	WARD AMALGAM CARVERS	56
MILLER TWEEZERS	32	RETRACTORS, MINI-LANGENBECK	81	WARD FILLING INSTRUMENTS	69
MILLER	132	RETRACTORS, UNIQUE	81	WAX KNIVES	76
MINI LIGATURE CUTTERS	100	RETRO FILLING	48	WEDELSTAEDT	71
MINI PIN & LIGATURE CUTTER TC	106	REVERSED LIGATURE CUTTER ANGLED	102	WEINGART GENERAL UTILITY PLIER LONG MOUTH WITH TC	103
MIXING SPATULA WITH SHOVEL	124	RHOIDIUM MIRRORS	30	WEINGART PLIER MEDIUM	99-101
MODIED MCCALL	60	ROCHESTER-KOCHER 1X2 HAEMOSTATIC FORCEPS	87	WEINGART PLIER REGULAR WITH TC	103
MOLT BONE FILES	94	ROCHESTER-PEAN HAEMOSTATIC FORCEPS	87	WEINGART PLIER SLIM WITH TC	102
MOLT PERIOSTEAL ELEVATORS	95	ROOT ELEVATOR	15-29	WEINGART PLIER UNIVERSAL WITH TC	103
MORTONSEN FILLING INSTRUMENT	55	ROOT PLANNING FILES	94	WEINGART PLIER UTILITY WITH TC	103
MOUTH GAG MOLT	78	ROOTS ELEVATOR	22	WEITLANDER CHEEK RETRACTORS	79
MOUTH MIRROR	37	ROSER-KÖNIG CHEEK RETRACTORS	79	WEITLANER CHEEK RETRACTORS	79
MSY CEMENT SPATULAS	75	ROUND NOSE PLIER	104	WERDELSTAEDT FILLING INSTRUMENTS	74
MULTIFUNCTIONAL METER	108	ROUNDED CONE	73	WESTON CEMENT SPATULAS	75
NAKAWALN. DENTAL LABORATORY INSTRUMENTS	77	ROUNDED-CONE FILLING INSTRUMENTS	49	WIDE MATRIX RETAINERS	91
NANCE LOOP FORMING PLIERS	99	RUBBER DAM CLAMPS	89	WILLIAM PROBE SET	38
NANCE PLIER	105	RUBBER DAM CLAMPS FORCEPS	89	WILLIAMS EXPLORERS	36
NARROW MATRIX RETAINERS	91	RUSSIAN LONG TISSUE FORCEPS	134	WINGURT PLIER SLIM	105
NEEDLE HOLDERS	85-86	RUSSIAN TISSUE FORCEPS	134	WINGURT UTILITY PLIER	105
NEUMANN SCISSORS	84	SCALER TRAY	148	WINTER ROOTS ELEVATOR	25
NOYES SCISSORS	84	SCALER/CURETTE SETS	60	WIRE BENDING & LOOP FORMING PLIERS	99
OCCUSAL ANATOMY INSTRUMENT	113	SCALER/CURETTE SETS INSTRUMENTS	61	WISDOM ROOTS ELEVATOR	21
OHL PERIOSTEAL ELEVATORS	95	SCHURE BAND SEATER	97	WOODEN HANDLE	76
OLSEN-HEGAR NEEDLE HOLDER WITH SCISSORS	98	SEAPARATING ELASTIC PLIER	88	WOODSON FILLING INSTRUMENTS	49
OREGON PLUGGERS/CONDENSERS	51	SELDIN PERIOSTEAL ELEVATORS	95	YOUNG PLIER WITH GROOVED	105
ORTHO BAND PUSHER SCALER	98	SELDIN RETRACTOR	82	YOUNG TONGUE FORCEPS	99
ORTHO INSTRUMENT	97	SELDIN ROOT ELEVATORS	15-18, 25	ZAHLE CEMENT SPATULAS	75
ORTHO LIGATURE DIRECTOR SINGLE ENDED	98	SELF LOCKING GROOVED	133		
ORTHO LIGHT BAND PUSHER SCALER	97-98	SELF-LOCKING TWEEZER	32		
ORTHO LIGHT DOUBLE ENDED LIGATURE DIRECTOR SCALER	98	SEMKEN TAYLOR TWEEZERS	31		
ORTHO LIGHT DOUBLE ENDED LIGATURE DIRECTOR	98	SICKLE PERIODONTAL INSTRUMENTS	39		
ORTHO LIGHT DOUBLE ENDED LIGATURE SCALER	98	SICKLE SCALERS INSTRUMENTS	58		
ORTHO LIGHT DOUBLE ENDED LIGATURE SCALER/DIRECTOR	98	SINGLE ENDED PROBE	33		
ORTHO LIGHT LIGATURE DIRECTOR DOUBLE ENDED	98	SINUS LIFT ELEVATOR	115-116		
ORTHO LIGHT SCALER DOUBLE ENDED	97				



Products that saves life

ZARYAB

I N S T R U M E N T S

 Harar, Wazirabad Road, Sialkot-51310, Pir Sabz Rd, Pir Sabz, Pakistan

 +92 52 3573775

 +92 52 3573776

 +92 333 8608580 , +92 333 3349600

 info@zaryabinstruments.com

 sales@zaryabinstruments.com

 www.zaryabinstruments.com