



*Products that saves life*

# ZARYAB

---

## INSTRUMENTS



## SUTURES

### Catalogue





Micro Needle Holder



ZI-11-002-15  
6"

with lockdiamond-coated jaw  
11,0 x 0,4 mm for suture material size 7-0 – 12-0



ZI-11-002-18  
7"

with lockdiamond-coated jaw  
11,0 x 0,4 mm for suture material size 7-0 – 12-0



ZI-11-003-15  
6"

with lockdiamond-coated jaw  
11,0 x 0,4 mm for suture material size 7-0 – 12-0



ZI-11-003-18  
7"

with lockdiamond-coated jaw  
11,0 x 0,4 mm for suture material size 7-0 – 12-0



Micro Needle Holder



ZI-11-004-15  
6"

diamond-coated jaw 11,0 x 0,4 mm for suture material size 7-0 – 12-0



ZI-11-004-18  
7"

diamond-coated jaw 11,0 x 0,4 mm for suture material size 7-0 – 12-0



ZI-11-005-15  
6"

diamond-coated jaw 11,0 x 0,4 mm for suture material size 7-0 – 12-0



ZI-11-005-18  
7"

diamond-coated jaw 11,0 x 0,4 mm for suture material size 7-0 – 12-0



ZI-11-010-15  
6"  
with  
lockdiamond-coated  
jaw 11,0 x 0,8 mm  
for suture material  
size 7-0 – 12-0



ZI-11-010-18  
7"  
with  
lockdiamond-coated  
jaw 11,0 x 0,8 mm  
for suture material  
size 7-0 – 12-0



ZI-11-010-21  
8 1/4"  
with  
lockdiamond-coated  
jaw 11,0 x 0,8 mm  
for suture material  
size 7-0 – 12-0



ZI-11-010-23  
9"  
with  
lockdiamond-coated  
jaw 11,0 x 0,8 mm  
for suture material  
size 7-0 – 12-0



ZI-11-011-15  
6"  
with  
lockdiamond-coated  
jaw 11,0 x 0,8 mm  
for suture material  
size 7-0 – 12-0



ZI-11-011-18  
7"  
with  
lockdiamond-coated  
jaw 11,0 x 0,8 mm  
for suture material  
size 7-0 – 12-0



ZI-11-011-21  
8 1/4"  
with  
lockdiamond-coated  
jaw 11,0 x 0,8 mm  
for suture material  
size 7-0 – 12-0



ZI-11-011-23  
9"  
with  
lockdiamond-coated  
jaw 11,0 x 0,8 mm  
for suture material  
size 7-0 – 12-0

Micro Needle Holder



Micro Needle Holder



ZI-11-012-15  
6"

diamond-coated jaw  
11,0 x 0,8 mm  
for suture material  
size 7-0 – 12-0



ZI-11-012-18  
7"

diamond-coated jaw  
11,0 x 0,8 mm  
for suture material  
size 7-0 – 12-0



ZI-11-012-21  
8 1/4"

diamond-coated jaw  
11,0 x 0,8 mm  
for suture material  
size 7-0 – 12-0



ZI-11-012-23  
9"

diamond-coated jaw  
11,0 x 0,8 mm  
for suture material  
size 7-0 – 12-0



ZI-11-013-15  
6"

diamond-coated jaw  
11,0 x 0,8 mm  
for suture material  
size 7-0 – 12-0



ZI-11-013-18  
7"

diamond-coated jaw  
11,0 x 0,8 mm  
for suture material  
size 7-0 – 12-0



ZI-11-013-21  
8 1/4"

diamond-coated jaw  
11,0 x 0,8 mm  
for suture material  
size 7-0 – 12-0



ZI-11-013-23  
9"

with lock  
diamond-coated jaw  
11,0 x 0,8 mm  
for suture material  
size 7-0 – 12-0



Micro Needle Holder  
ZI-11-016-15  
6"  
with lockd  
iamond-coated jaw 11,0 x 0,4 mm  
for suture material size 7-0 – 12-0



Micro Needle Holder  
ZI-11-016-18  
7"  
with lockd  
iamond-coated jaw 11,0 x 0,4 mm  
for suture material size 7-0 – 12-0



Micro Needle Holder



ZI-11-017-15  
6"  
with lock  
diamond-coated jaw  
11,0 x 0,4 mm  
for suture material size  
7-0 – 12-0



ZI-11-017-18  
7"  
with lock  
diamond-coated jaw  
11,0 x 0,4 mm  
for suture material size  
7-0 – 12-0



ZI-11-018-15  
6"  
diamond-coated jaw  
11,0 x 0,4 mm  
for suture material size  
7-0 – 12-0



ZI-11-018-18  
7"  
diamond-coated jaw  
11,0 x 0,4 mm  
for suture material size  
7-0 – 12-0



ZI-11-019-15  
6"  
diamond-coated jaw  
11,0 x 0,4 mm  
for suture material size  
7-0 – 12-0



ZI-11-019-18  
7"  
diamond-coated jaw  
11,0 x 0,4 mm  
for suture material size  
7-0 – 12-0



ZI-11-020-15  
6"  
with lock  
diamond-coated jaw  
11,0 x 0,8 mm  
for suture material size  
7-0 – 12-0



ZI-11-020-18  
7"  
with lock  
diamond-coated jaw  
11,0 x 0,8 mm  
for suture material size  
7-0 – 12-0



ZI-11-020-21  
8 1/4"  
with lock  
diamond-coated jaw  
11,0 x 0,8 mm  
for suture material size  
7-0 – 12-0



ZI-11-021-15  
6"  
with lock  
diamond-coated jaw  
11,0 x 0,8 mm  
for suture material size  
7-0 – 12-0



ZI-11-021-18  
7"  
with lock  
diamond-coated jaw  
11,0 x 0,8 mm  
for suture material size  
7-0 – 12-0



ZI-11-021-21  
8 1/4"  
with lock  
diamond-coated jaw  
11,0 x 0,8 mm  
for suture material size  
7-0 – 12-0

Micro Needle Holder





Micro Needle Holder



ZI-11-022-15  
6"  
diamond-coated jaw  
11,0 x 0,8 mm  
for suture material size  
7-0 – 12-0



ZI-11-022-18  
7"  
diamond-coated jaw  
11,0 x 0,8 mm  
for suture material size  
7-0 – 12-0



ZI-11-022-21  
8 1/4"  
diamond-coated jaw  
11,0 x 0,8 mm  
for suture material size  
7-0 – 12-0



ZI-11-023-15  
6"  
diamond-coated jaw  
11,0 x 0,8 mm  
for suture material size  
7-0 – 12-0



ZI-11-023-18  
7"  
diamond-coated jaw  
11,0 x 0,8 mm  
for suture material size  
7-0 – 12-0



ZI-11-023-21  
8 1/4"  
diamond-coated jaw  
11,0 x 0,8 mm  
for suture material size  
7-0 – 12-0

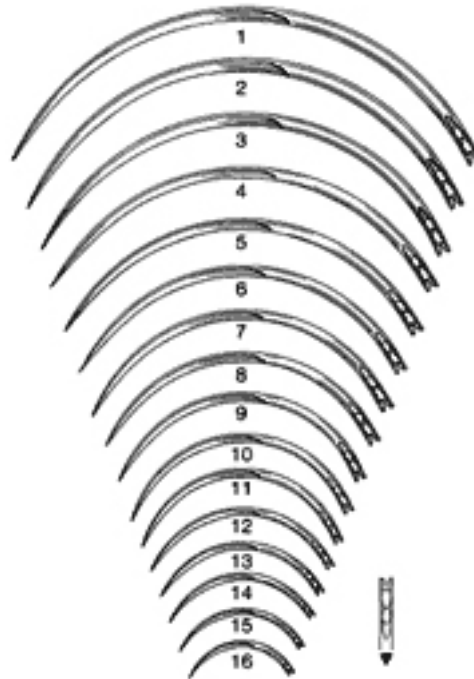

ZI-11-113-01

Surgical Needle Fig. 1 curved 3/8 circle unit for sale 1 dozen

ZI-11-113-02

Surgical Needle Fig. 2 curved 3/8 circle unit for sale 1 dozen

ZI-11-113-03

Surgical Needle Fig. 3 curved 3/8 circle unit for sale 1 dozen

ZI-11-113-04

Surgical Needle Fig. 4 curved 3/8 circle unit for sale 1 dozen

ZI-11-113-05

Surgical Needle Fig. 5 curved 3/8 circle unit for sale 1 dozen

ZI-11-113-06

Surgical Needle Fig. 6 curved 3/8 circle unit for sale 1 dozen

ZI-11-113-07

Surgical Needle Fig. 7 curved 3/8 circle unit for sale 1 dozen

ZI-11-113-08

Surgical Needle Fig. 8 curved 3/8 circle unit for sale 1 dozen

ZI-11-113-09

Surgical Needle Fig. 9 curved 3/8 circle unit for sale 1 dozen

ZI-11-113-10

Surgical Needle Fig. 10 curved 3/8 circle unit for sale 1 dozen

ZI-11-113-11

Surgical Needle Fig. 11 curved 3/8 circle unit for sale 1 dozen

ZI-11-113-12

Surgical Needle Fig. 12 curved 3/8 circle unit for sale 1 dozen

ZI-11-113-13

Surgical Needle Fig. 13 curved 3/8 circle unit for sale 1 dozen

ZI-11-113-14

Surgical Needle Fig. 14 curved 3/8 circle unit for sale 1 dozen

ZI-11-113-15

Surgical Needle Fig. 15 curved 3/8 circle unit for sale 1 dozen

ZI-11-113-16

Surgical Needle Fig. 16 curved 3/8 circle unit for sale 1 dozen



- ZI-11-123-01  
Surgical Needle Fig. 1 curved 1/2 circle unit for sale 1 dozen
- ZI-11-123-02  
Surgical Needle Fig. 2 curved 1/2 circle unit for sale 1 dozen
- ZI-11-123-03  
Surgical Needle Fig. 3 curved 1/2 circle unit for sale 1 dozen
- ZI-11-123-04  
Surgical Needle Fig. 4 curved 1/2 circle unit for sale 1 dozen
- ZI-11-123-05  
Surgical Needle Fig. 5 curved 1/2 circle unit for sale 1 dozen
- ZI-11-123-06  
Surgical Needle Fig. 6 curved 1/2 circle unit for sale 1 dozen
- ZI-11-123-07  
Surgical Needle Fig. 7 curved 1/2 circle unit for sale 1 dozen
- ZI-11-123-08  
Surgical Needle Fig. 8 curved 1/2 circle unit for sale 1 dozen
- ZI-11-123-09  
Surgical Needle Fig. 9 curved 1/2 circle unit for sale 1 dozen
- ZI-11-123-10  
Surgical Needle Fig. 10 curved 1/2 circle unit for sale 1 dozen
- ZI-11-123-11  
Surgical Needle Fig. 11 curved 1/2 circle unit for sale 1 dozen
- ZI-11-123-12  
Surgical Needle Fig. 12 curved 1/2 circle unit for sale 1 dozen
- ZI-11-123-13  
Surgical Needle Fig. 13 curved 1/2 circle unit for sale 1 dozen
- ZI-11-123-14  
Surgical Needle Fig. 14 curved 1/2 circle unit for sale 1 dozen
- ZI-11-123-15  
Surgical Needle Fig. 15 curved 1/2 circle unit for sale 1 dozen
- ZI-11-123-16  
Surgical Needle Fig. 16 curved 1/2 circle unit for sale 1 dozen

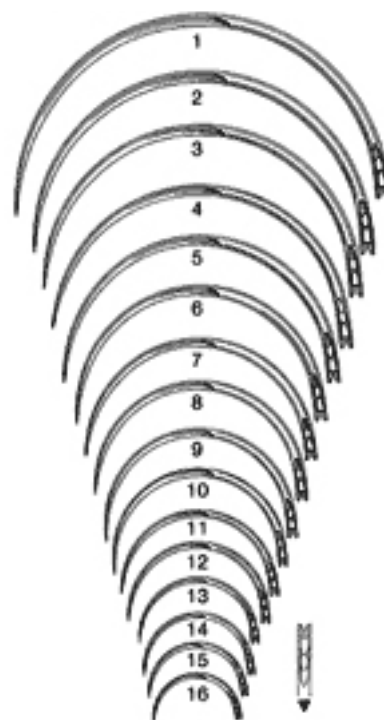



ZI-11-127-01

Surgical Needle Fig. 1 curved 1/2 circle unit for sale 1 dozen

ZI-11-127-02

Surgical Needle Fig. 2 curved 1/2 circle unit for sale 1 dozen

ZI-11-127-03

Surgical Needle Fig. 3 curved 1/2 circle unit for sale 1 dozen

ZI-11-127-04

Surgical Needle Fig. 4 curved 1/2 circle unit for sale 1 dozen

ZI-11-127-05

Surgical Needle Fig. 5 curved 1/2 circle unit for sale 1 dozen

ZI-11-127-06

Surgical Needle Fig. 6 curved 1/2 circle unit for sale 1 dozen

ZI-11-127-07

Surgical Needle Fig. 7 curved 1/2 circle unit for sale 1 dozen

ZI-11-127-08

Surgical Needle Fig. 8 curved 1/2 circle unit for sale 1 dozen

ZI-11-127-09

Surgical Needle Fig. 9 curved 1/2 circle unit for sale 1 dozen

ZI-11-127-10

Surgical Needle Fig. 10 curved 1/2 circle unit for sale 1 dozen

ZI-11-127-11

Surgical Needle Fig. 11 curved 1/2 circle unit for sale 1 dozen

ZI-11-127-12

Surgical Needle Fig. 12 curved 1/2 circle unit for sale 1 dozen

ZI-11-127-13

Surgical Needle Fig. 13 curved 1/2 circle unit for sale 1 dozen

ZI-11-127-14

Surgical Needle Fig. 14 curved 1/2 circle unit for sale 1 dozen

ZI-11-127-15

Surgical Needle Fig. 15 curved 1/2 circle unit for sale 1 dozen

ZI-11-127-16

Surgical Needle Fig. 16 curved 1/2 circle unit for sale 1 dozen

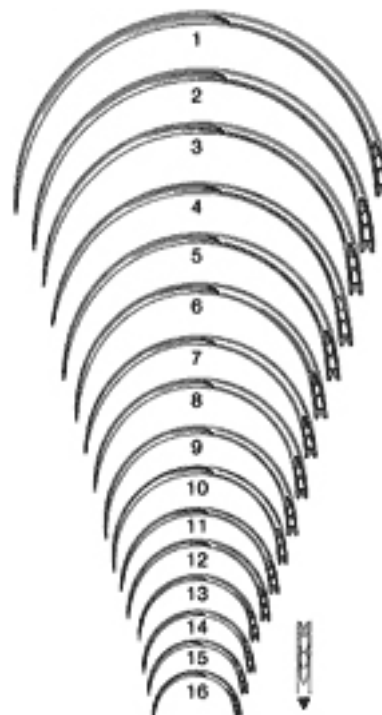

ZI-11-133-01

Surgical Needle Fig. 1 curved 1/2 circle unit for sale 1 dozen

ZI-11-133-02

Surgical Needle Fig. 2 curved 1/2 circle unit for sale 1 dozen

ZI-11-133-03

Surgical Needle Fig. 3 curved 1/2 circle unit for sale 1 dozen

ZI-11-133-04

Surgical Needle Fig. 4 curved 1/2 circle unit for sale 1 dozen

ZI-11-133-05

Surgical Needle Fig. 5 curved 1/2 circle unit for sale 1 dozen

ZI-11-133-06

Surgical Needle Fig. 6 curved 1/2 circle unit for sale 1 dozen

ZI-11-133-07

Surgical Needle Fig. 7 curved 1/2 circle unit for sale 1 dozen

ZI-11-133-08

Surgical Needle Fig. 8 curved 1/2 circle unit for sale 1 dozen

ZI-11-133-09

Surgical Needle Fig. 9 curved 1/2 circle unit for sale 1 dozen

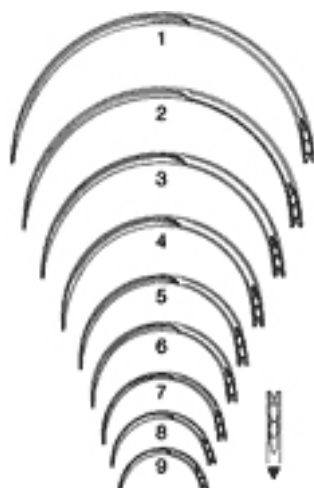



- ZI-11-154-10  
Surgical Needle Fig. 0 curved 1/2 circle unit for sale 1 dozen
- ZI-11-154-20  
Surgical Needle Fig. 00 curved 1/2 circle unit for sale 1 dozen
- ZI-11-154-30  
Surgical Needle Fig. 000 curved 1/2 circle unit for sale 1 dozen
- ZI-11-155-01  
Surgical Needle Fig. 1 curved 3/8 circle unit for sale 1 dozen
- ZI-11-155-02  
Surgical Needle Fig. 2 curved 3/8 circle unit for sale 1 dozen
- ZI-11-155-03  
Surgical Needle Fig. 3 curved 3/8 circle unit for sale 1 dozen
- ZI-11-155-04  
Surgical Needle Fig. 4 curved 3/8 circle unit for sale 1 dozen
- ZI-11-155-05  
Surgical Needle Fig. 5 curved 3/8 circle unit for sale 1 dozen

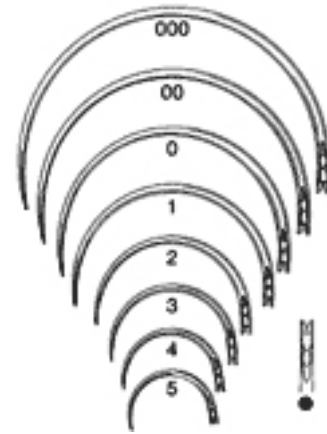

- ZI-11-161-01  
Keith  
Surgical Needle Fig. 1 unit for sale 1 dozen
- ZI-11-161-02  
Keith  
Surgical Needle Fig. 2 unit for sale 1 dozen
- ZI-11-161-03  
Keith  
Surgical Needle Fig. 3 unit for sale 1 dozen
- ZI-11-161-04  
Keith  
Surgical Needle Fig. 4 unit for sale 1 dozen
- ZI-11-161-05  
Keith  
Surgical Needle Fig. 5 unit for sale 1 dozen
- ZI-11-161-06  
Keith  
Surgical Needle Fig. 6 unit for sale 1 dozen

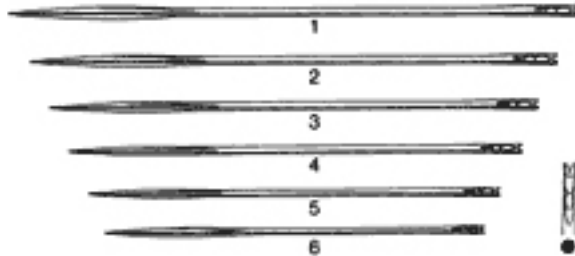

ZI-11-165-01

Keith

Surgical Needle Fig. 1 unit for sale 1 dozen

ZI-11-165-02

Keith

Surgical Needle Fig. 2 unit for sale 1 dozen

ZI-11-165-03

Keith

Surgical Needle Fig. 3 unit for sale 1 dozen

ZI-11-165-04

Keith

Surgical Needle Fig. 4 unit for sale 1 dozen

ZI-11-165-05

Keith

Surgical Needle Fig. 5 unit for sale 1 dozen

ZI-11-165-06

Keith

Surgical Needle Fig. 6 unit for sale 1 dozen

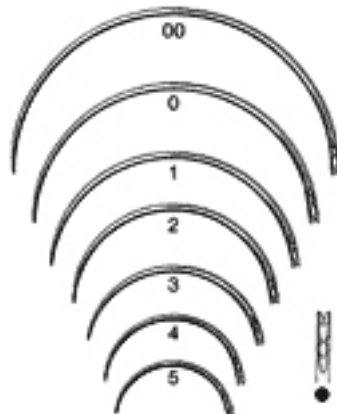

ZI-11-175-10

Intestinal Needle Fig. 0 curved 1/2 circle unit for sale 1 dozen

ZI-11-175-20

Intestinal Needle Fig. 00 curved 1/2 circle unit for sale 1 dozen



ZI-11-176-01

Intestinal Needle Fig. 1 curved 1/2 circle unit for sale 1 dozen

ZI-11-176-02

Intestinal Needle Fig. 2 curved 1/2 circle unit for sale 1 dozen

ZI-11-176-03

Intestinal Needle Fig. 3 curved 1/2 circle unit for sale 1 dozen

ZI-11-176-04

Intestinal Needle Fig. 4 curved 1/2 circle unit for sale 1 dozen

ZI-11-176-05

Intestinal Needle Fig. 5 curved 1/2 circle unit for sale 1 dozen

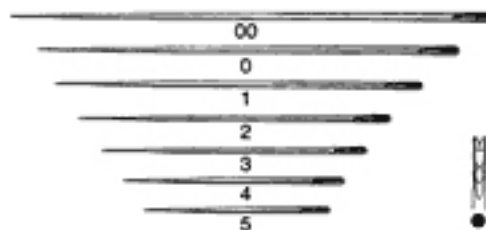

ZI-11-182-10

Intestinal Needle Fig. 0 curved 3/8 circle unit for sale 1 dozen

ZI-11-182-20

Intestinal Needle Fig. 00 curved 3/8 circle unit for sale 1 dozen

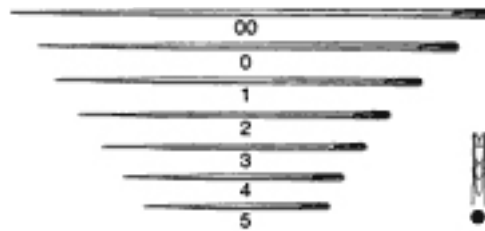

ZI-11-183-01

Intestinal Needle Fig. 1 curved 3/8 circle unit for sale 1 dozen

ZI-11-183-02

Intestinal Needle Fig. 2 curved 3/8 circle unit for sale 1 dozen

ZI-11-183-03

Intestinal Needle Fig. 3 curved 3/8 circle unit for sale 1 dozen

ZI-11-183-04

Intestinal Needle Fig. 4 curved 3/8 circle unit for sale 1 dozen

ZI-11-183-05

Intestinal Needle Fig. 5 curved 3/8 circle unit for sale 1 dozen



ZI-11-187-10

Intestinal Needle Fig. 0 curved 3/8 circle unit for sale 1 dozen

ZI-11-187-20

Intestinal Needle Fig. 00 curved 3/8 circle unit for sale 1 dozen





ZI-11-188-01

Intestinal Needle Fig. 1 curved 3/8 circle unit for sale 1 dozen

ZI-11-188-02

Intestinal Needle Fig. 2 curved 3/8 circle unit for sale 1 dozen

ZI-11-188-03

Intestinal Needle Fig. 3 curved 3/8 circle unit for sale 1 dozen

ZI-11-188-04

Intestinal Needle Fig. 4 curved 3/8 circle unit for sale 1 dozen

ZI-11-188-05

Intestinal Needle Fig. 5 curved 3/8 circle unit for sale 1 dozen



ZI-11-205-01

Eye Needle Fig. 1 curved 3/8 circle unit for sale 1 dozen

ZI-11-205-02

Eye Needle Fig. 2 curved 3/8 circle unit for sale 1 dozen

ZI-11-205-03

Eye Needle Fig. 3 curved 3/8 circle unit for sale 1 dozen

ZI-11-205-04

Eye Needle Fig. 4 curved 3/8 circle unit for sale 1 dozen

ZI-11-205-05

Eye Needle Fig. 5 curved 3/8 circle unit for sale 1 dozen



ZI-11-209-01

Eye Needle Fig. 1 curved 1/2 circle unit for sale 1 dozen

ZI-11-209-02

Eye Needle Fig. 2 curved 1/2 circle unit for sale 1 dozen

ZI-11-209-03

Eye Needle Fig. 3 curved 1/2 circle unit for sale 1 dozen

ZI-11-209-04

Eye Needle Fig. 4 curved 1/2 circle unit for sale 1 dozen

ZI-11-209-05

Eye Needle Fig. 5 curved 1/2 circle unit for sale 1 dozen



ZI-11-220-10

Kalt

Vascular Needle Fig. 0 curved 3/8 circle unit for sale 1 dozen

ZI-11-220-20

Kalt

Vascular Needle Fig. 00 curved 3/8 circle unit for sale 1 dozen

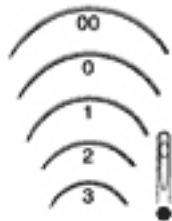

ZI-11-221-01

Kalt

Vascular Needle Fig. 1 curved 3/8 circle unit for sale 1 dozen

ZI-11-221-0

2 Kalt

Vascular Needle Fig. 2 curved 3/8 circle unit for sale 1 dozen

HIM-11-221-03

Kalt

Vascular Needle Fig. 3 curved 3/8 circle unit for sale 1 dozen

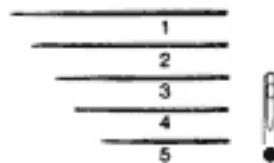

ZI-11-226-01

Payr

Vascular Needle Fig. 1 unit for sale 1 dozen

ZI-11-226-02

Payr

Vascular Needle Fig. 2 unit for sale 1 dozen

ZI-11-226-03

Payr

Vascular Needle Fig. 3 unit for sale 1 dozen

ZI-11-226-04

Payr

Vascular Needle Fig. 4 unit for sale 1 dozen

ZI-11-226-05

Payr

Vascular Needle Fig. 5 unit for sale 1 dozen

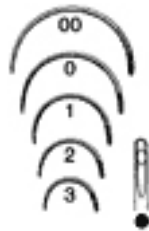

ZI-11-230-10

Payr

Vascular Needle Fig. 0 curved 3/8 circle unit for sale 1 dozen

ZI-11-230-20

Payr

Vascular Needle Fig. 00 curved 3/8 circle unit for sale 1 dozen



ZI-11-231-01

Payr

Vascular Needle Fig. 1 curved 3/8 circle unit for sale 1 dozen

ZI-11-231-02

Payr

Vascular Needle Fig. 2 curved 3/8 circle unit for sale 1 dozen

ZI-11-231-03

Payr

Vascular Needle Fig. 3 curved 3/8 circle unit for sale 1 dozen



**ZARYAB**  
I N S T R U M E N T S

*Products that saves life*

## Suture



Needle Holder  
Kalt  
ZI-11-274-14  
5 1/4"



Micro Needle Holder  
Barraquer-Troutman

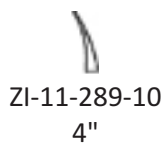
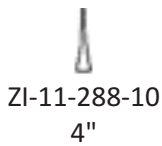

Micro Needle Holder  
Arruga

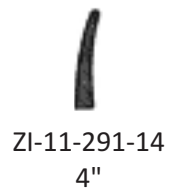



**ZARYAB**  
I N S T R U M E N T S

*Products that saves life*

## Suture



Micro Needle Holder  
Barraquer-Troutman  
ZI-11-298-10  
4"

Micro Needle Holder  
Barraquer-Troutman  
ZI-11-298-11  
4 1/2"

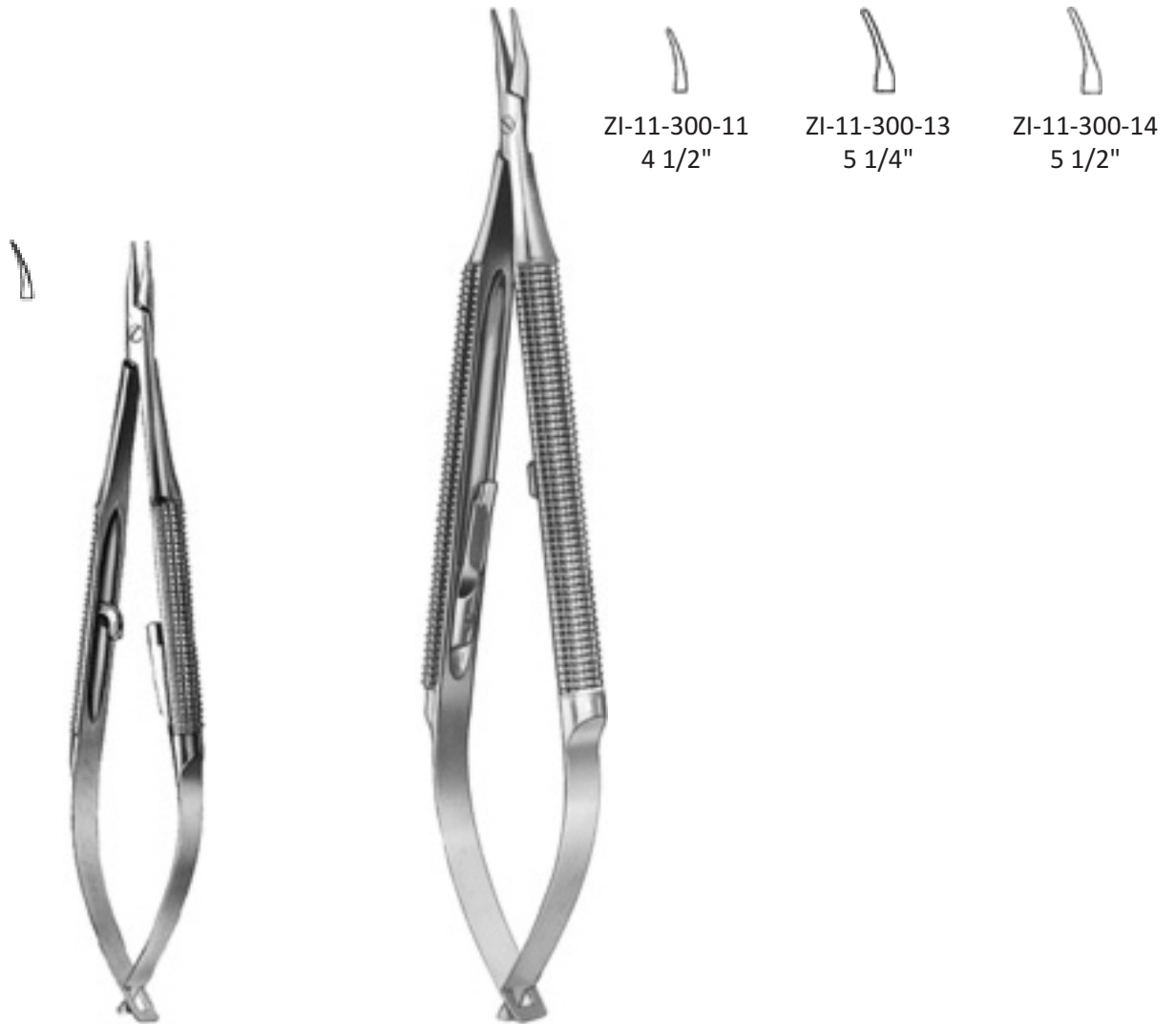

Micro Needle Holder'  
Barraquer  
ZI-11-299-10  
4"

Micro Needle Holder'  
Barraquer  
ZI-11-299-11  
4 1/2"

Micro Needle Holder  
Barraquer

ZI-11-300-11  
4 1/2"

ZI-11-300-13  
5 1/4"

ZI-11-300-14  
5 1/2"



**ZARYAB**  
I N S T R U M E N T S

*Products that saves life*

## Suture



Micro Needle Holder  
Barraquer  
ZI-11-301-13  
5 1/4"





Micro Needle Holder  
Castroviejo-Fino

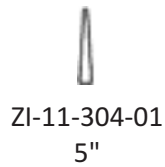
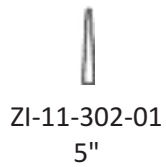

Micro Needle Holder  
Castroviejo-Fino  
ZI-11-305-01  
5"



Micro Needle Holder  
Castroviejo  
ZI-11-306-14  
5 1/2"  
with lock



Micro Needle Holder  
Castroviejo  
ZI-11-307-14  
5 1/2"  
with lock



Micro Needle Holder  
Castroviejo  
ZI-11-308-14  
5 1/2"



Micro Needle Holder  
Castroviejo  
ZI-11-309-14  
5 1/2"



Micro Needle Holder  
Castroviejo  
ZI-11-310-14  
5 1/2"



Micro Needle Holder  
Castroviejo  
ZI-11-311-14  
5 1/2"



Micro Needle Holder  
Castroviejo  
ZI-11-313-14  
5 1/2"



**ZARYAB**  
I N S T R U M E N T S

*Products that saves life*

## Suture



ZI-11-314-16  
6 1/4"



ZI-11-315-16  
6 1/4"

Needle Holder  
Arruga



**ZARYAB**  
I N S T R U M E N T S

*Products that saves life*

## Suture



Micro Needle Holder  
Castroviejo  
ZI-11-316-13  
4 3/4"



Micro Needle Holder  
Castroviejo  
ZI-11-317-12  
4 3/4"



Needle Holder  
Derf  
ZI-11-326-12  
4 3/4"  
one fenestrated jaw



Needle Holder  
Derf  
ZI-11-328-12  
5"  
jaw with longitudinal serration



Needle Holder  
Collier  
ZI-11-332-12  
5"  
grooved jaw



Needle Holder  
Webster  
ZI-11-334-13  
5"  
smooth jaw



Needle Holder  
Halsey  
ZI-11-336-13  
5 1/4"  
smooth jaw



Needle Holder  
Neivert  
ZI-11-338-13  
5"  
smooth jaw, special groove





Needle Holder  
Hegar-Baumgartner  
ZI-11-340-14  
5 3/4"



Needle Holder  
Brown  
ZI-11-344-13  
5"  
heavy pattern diagonally serrated jaw



Needle Holder  
Brown  
ZI-11-344-18  
7"

heavy pattern diagonally serrated jaw



Needle Holder  
Crile-Murray  
ZI-11-348-15  
6"

slender pattern



Needle Holder  
Crile-Wood  
ZI-11-350-15  
6"



Needle Holder  
Adson  
ZI-11-360-18  
7"



**ZARYAB**  
I N S T R U M E N T S

*Products that saves life*

## Suture



Needle Holder  
Metzenbaum  
ZI-11-364-18  
7 1/4"



Needle Holder  
M. G. Hospital  
ZI-11-384-17  
6 3/4"  
heavy pattern

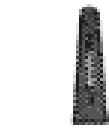
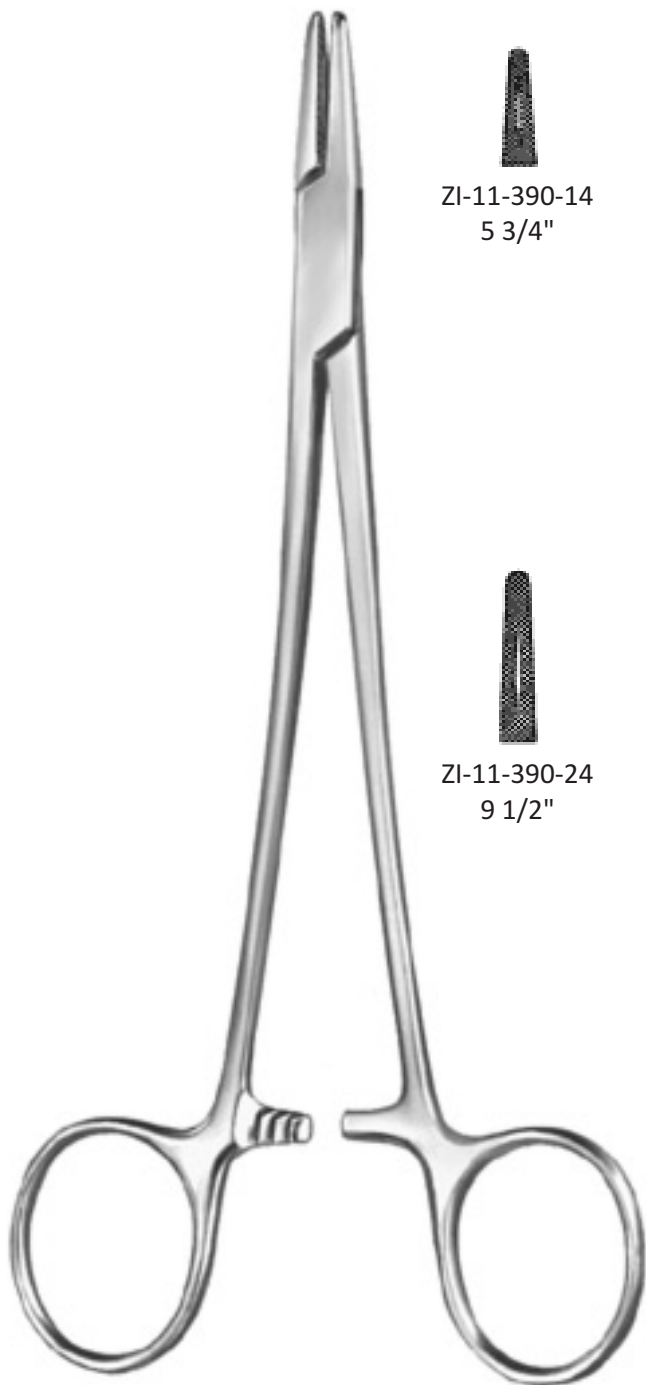

ZI-11-390-14  
5 3/4"

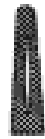

ZI-11-390-16  
6 1/4"



ZI-11-390-18  
7 1/4"

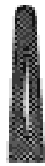

ZI-11-390-20  
8"



ZI-11-390-24  
9 1/2"



ZI-11-390-26  
10 1/2"



ZI-11-390-30  
12"

Needle Holder  
Mayo-Hegar



**ZARYAB**  
I N S T R U M E N T S

*Products that saves life*

## Suture



ZI-11-396-16  
6 1/4"  
slender pattern



ZI-11-396-18  
7 1/4"  
slender pattern



ZI-11-396-20  
8"  
slender pattern

Needle Holder  
Mayo-Hegar



**ZARYAB**  
I N S T R U M E N T S

*Products that saves life*

## Suture



Needle Holder  
Heaney  
ZI-11-403-21  
8"



Needle Holder  
Jamison  
ZI-11-404-23  
9 1/4"



**ZARYAB**  
I N S T R U M E N T S

*Products that saves life*

## Suture



Needle Holder  
Masson  
ZI-11-408-27  
10 1/2"



Needle Holder  
Finochietto  
ZI-11-415-27  
10 1/2"





Needle Holder  
Wangensteen  
ZI-11-420-27  
10 1/2"



Needle Holder  
Johnson  
ZI-11-437-27  
10 3/4"

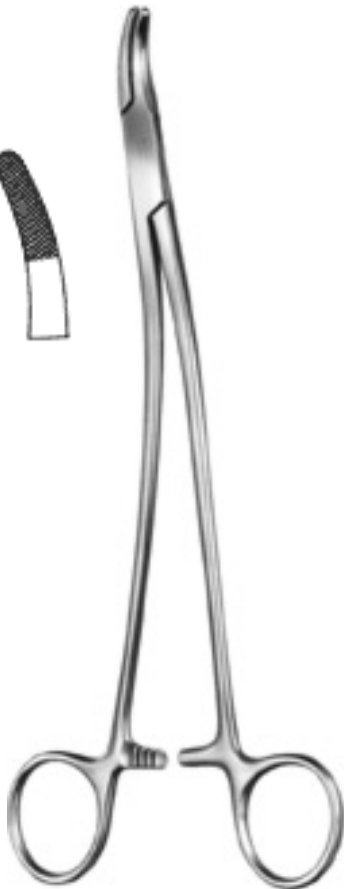

Needle Holder  
Stratte  
ZI-11-451-23  
9"

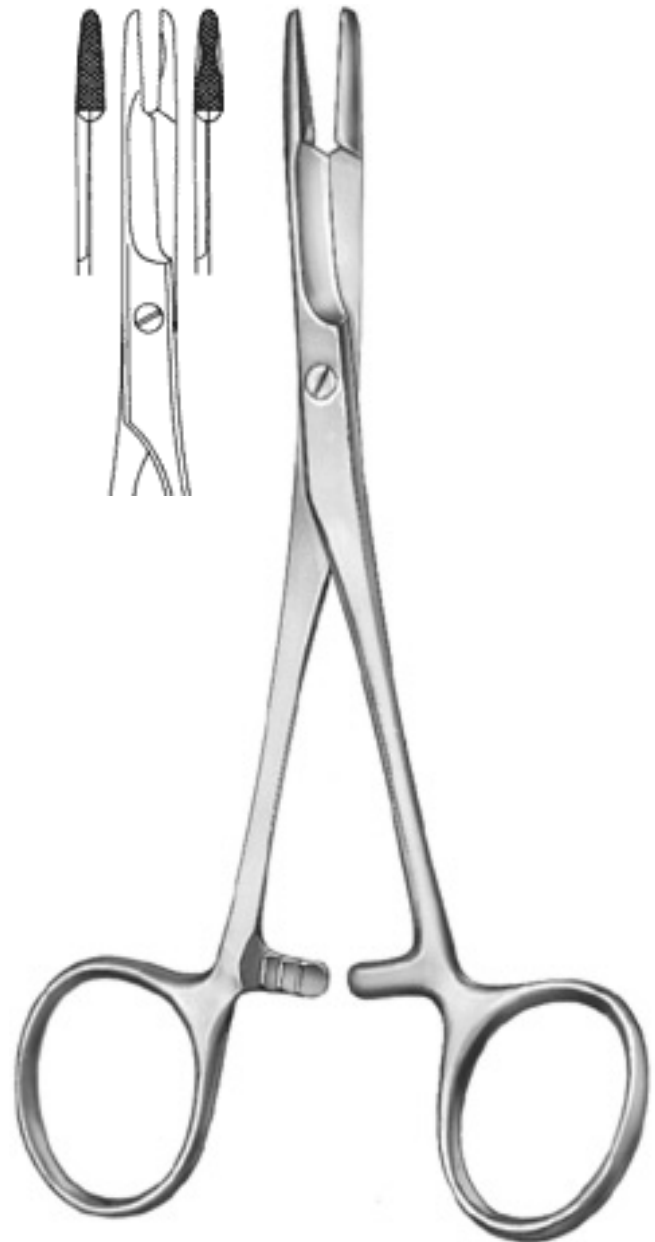
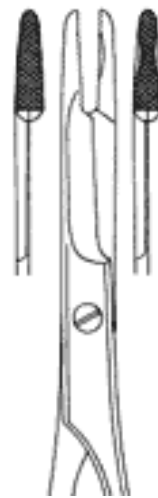

Needle Holder  
Olsen-Hegar  
ZI-11-466-14  
5 1/2"



Needle Holder  
Gillies  
ZI-11-469-16  
6 1/4"



Needle Holder  
Crile  
ZI-11-500-15  
6"



**ZARYAB**  
I N S T R U M E N T S

*Products that saves life*

## Suture



ZI-11-516-14  
5 1/2"



ZI-11-516-17  
6 3/4"



ZI-11-516-20  
8"

Needle Holder  
Mathieu



**ZARYAB**  
I N S T R U M E N T S

*Products that saves life*

## Suture

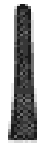

ZI-11-526-14  
5 1/2"



ZI-11-526-17  
6 1/2"

Needle Holder  
Mathieu



Needle Holder  
Toennis  
ZI-11-574-18  
7 1/4"



Needle Holder  
Lichtenberg  
ZI-11-576-20  
8"



Micro Needle Holder  
ZI-11-589-16  
6 1/2"  
smooth, curved jaw

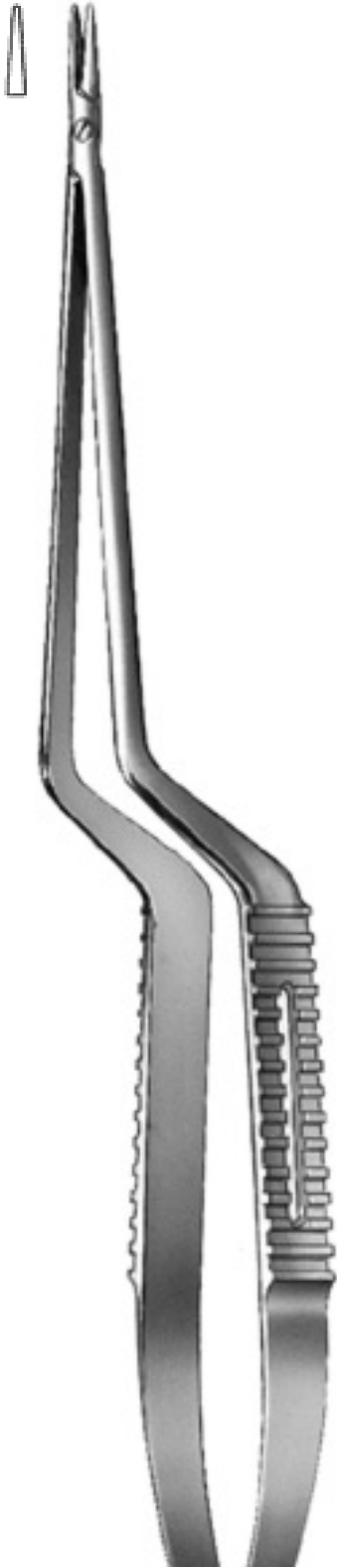

Micro Needle Holder  
ZI-11-592-23  
9"  
smooth ,straight jaw

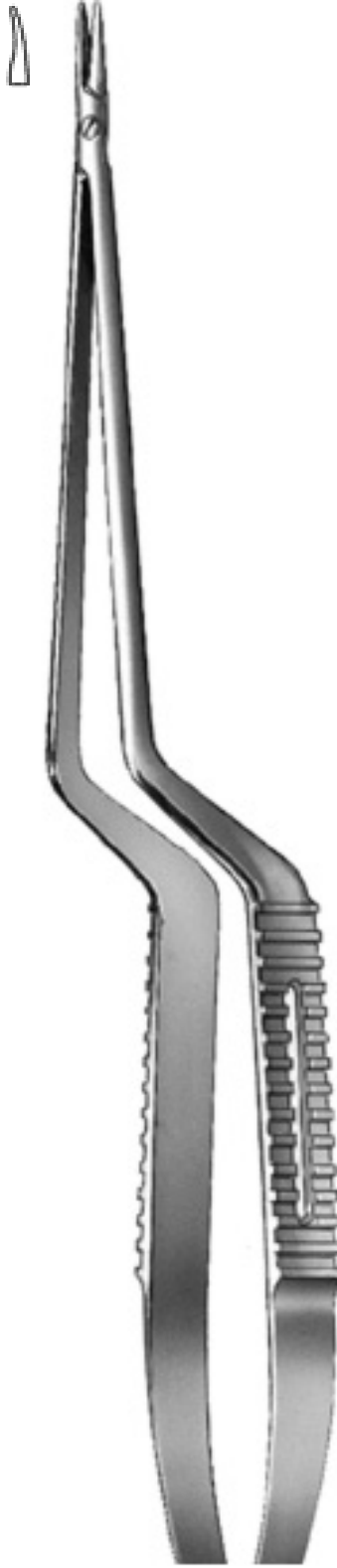

Micro Needle Holder  
ZI-11-593-23  
8"  
smooth, curved jaw

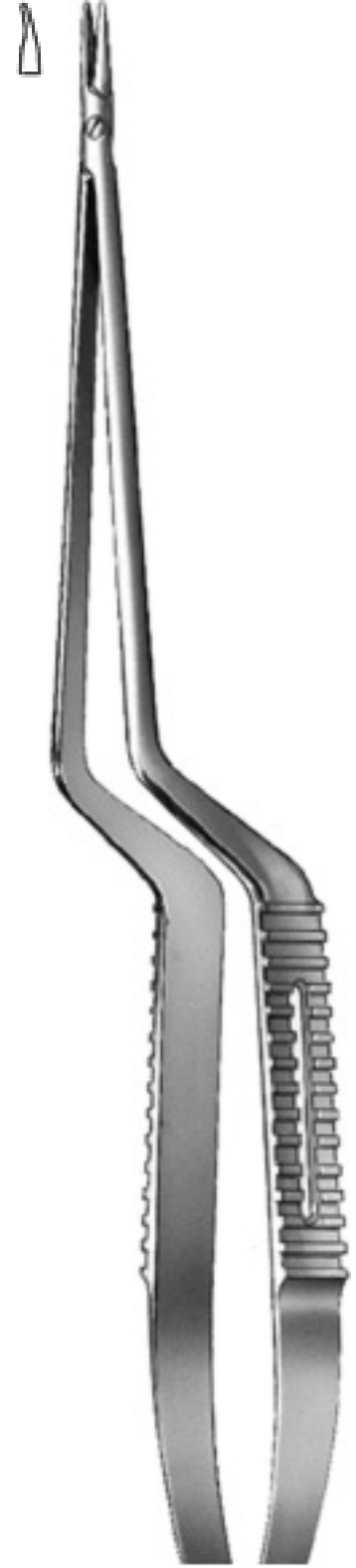

Micro Needle Holder  
ZI-11-595-19  
7 1/2"  
smooth, curved jaw



Micro Needle Holder  
Hepp-Scheidel  
ZI-11-602-18  
7"  
for suture material  
size 6-0 – 12-0



Needle Holder



Webster  
ZI-11-604-13  
5"  
mini profile  
for suture  
material  
size 4-0 – 6-0

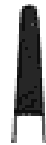

Webster  
ZI-11-604-15  
6"  
mini profile  
for suture  
material  
size 4-0 – 6-0





ZI-11-605-15  
6"  
with lock  
diamond-coated  
jaw, 2,0 mm wide  
for suture material  
size 4-0 – 6-0



ZI-11-605-18  
7"  
with lock  
diamond-coated  
jaw, 2,0 mm wide  
for suture material  
size 4-0 – 6-0



ZI-11-605-21  
8 1/4"  
with lock  
diamond-coated  
jaw, 2,0 mm wide  
for suture material  
size 4-0 – 6-0



ZI-11-605-23  
9"  
with lock  
diamond-coated  
jaw, 2,0 mm wide  
for suture material  
size 4-0 – 6-0



ZI-11-606-15  
6"  
with lock  
diamond-coated  
jaw, 2,0 mm wide  
for suture material  
size 4-0 – 6-0



ZI-11-606-18  
7"  
with lock  
diamond-coated  
jaw, 2,0 mm wide  
for suture material  
size 4-0 – 6-0



ZI-11-606-21  
8 1/4"  
with lock  
diamond-coated  
jaw, 2,0 mm wide  
for suture material  
size 4-0 – 6-0



ZI-11-606-23  
9"  
with lock  
diamond-coated  
jaw, 2,0 mm wide  
for suture material  
size 4-0 – 6-0

Micro Needle Holder



ZI-11-607-15  
6"  
without lockd  
iamond-coated  
jaw, 2,0 mm wide  
for suture material  
size 4-0 – 6-0



ZI-11-607-18  
7"  
without lockd  
iamond-coated  
jaw, 2,0 mm wide  
for suture material  
size 4-0 – 6-0



ZI-11-607-21  
8 1/4"  
without lockd  
iamond-coated  
jaw, 2,0 mm wide  
for suture material  
size 4-0 – 6-0



ZI-11-607-23  
9"  
without lockd  
iamond-coated  
jaw, 2,0 mm wide  
for suture material  
size 4-0 – 6-0

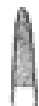

ZI-11-608-15  
6"  
without lockd  
iamond-coated  
jaw, 2,0 mm wide  
for suture material  
size 4-0 – 6-0

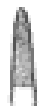

ZI-11-608-18  
7"  
without lockd  
iamond-coated  
jaw, 2,0 mm wide  
for suture material  
size 4-0 – 6-0

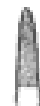

ZI-11-608-21  
8 1/4"  
without lockd  
iamond-coated  
jaw, 2,0 mm wide  
for suture material  
size 4-0 – 6-0

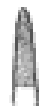

ZI-11-608-23  
9"  
without lockd  
iamond-coated  
jaw, 2,0 mm wide  
for suture material  
size 4-0 – 6-0

Micro Needle Holder



**ZARYAB**  
I N S T R U M E N T S

Products that saves life

## Suture



Micro Needle Holder  
JABOMA  
ZI-11-610-18

7"with lockmicro profilefor suture material size 5-0 – 8-0



Micro Needle Holder  
Gregory



ZI-11-612-18  
7"

with lockd  
iamond-coated jaw  
for suture material  
size 4-0 – 6-0



ZI-11-612-21  
8 1/4"

with lockd  
iamond-coated jaw  
for suture material  
size 4-0 – 6-0



Micro Needle Holder  
Castroviejo



ZI-11-620-00  
5 3/4"  
with lock  
micro profile  
for suture material  
size 5-0 – 8-0



ZI-11-620-01  
5 3/4"  
with lock  
micro profile  
for suture material  
size 5-0 – 8-0



ZI-11-620-14  
5 3/4"  
smooth jaw  
for suture material  
size 6-0 – 12-0



ZI-11-620-18  
7"  
with lock  
micro profile  
for suture material  
size 5-0 – 8-0



ZI-11-620-21  
8 1/2"  
with lock  
micro profile  
for suture material  
size 5-0 – 8-0



ZI-11-621-14  
5 3/4"  
smooth jaw  
for suture material  
size 6-0 – 12-0



ZI-11-621-18  
7"  
with lock  
micro profile  
for suture material  
size 5-0 – 8-0



ZI-11-621-21  
8 1/2"  
with lock  
micro profile  
for suture material  
size 5-0 – 8-0



Arruga  
Needle Holder



ZI-11-622-16  
6 1/4" mini profile  
for suture material  
size 4-0 – 6-0



ZI-11-623-16  
6 1/4" mini profile  
for suture material  
size 4-0 – 6-0



Micro Needle Holder  
Castroviejo  
ZI-11-624-13  
5"

with lock, smooth jaw for suture material size 6-0 – 12-0



**ZARYAB**  
I N S T R U M E N T S

*Products that saves life*

## Suture



Micro Needle Holder  
Barraquer  
ZI-11-626-13  
5"  
with lock, smooth jaw  
for suture material  
size 6-0 – 12-0



Micro Needle Holder  
Barraquer  
ZI-11-628-13  
5"  
smooth jaw  
for suture material  
size 6-0 – 12-0



Needle Holder  
Webster  
ZI-11-630-13  
5"  
smooth jaw  
for suture material  
size 6-0 – 12-0



Needle Holder  
Kilner  
ZI-11-631-13  
5"  
mini profile  
for suture material  
size 4-0 – 6-0



Needle Holder  
Derf  
ZI-11-632-12  
4 3/4"  
mini profile  
for suture material  
size 4-0 – 6-0



Needle Holder  
Hegar-Baumgartner  
ZI-11-634-13  
5"  
mini profile  
for suture materia  
size 4-0 – 6-0





Needle Holder  
Hegar-Baumgartner  
ZI-11-634-14  
5 3/4"  
mini profile  
for suture materia  
size 4-0 – 6-0



Needle Holder  
Halsey  
ZI-11-636-13  
5"  
smooth jaw  
for suture material  
size 6-0 – 12-0



Needle Holder  
Webster  
ZI-11-637-12  
4 3/4"  
smooth jaw  
for suture material  
size 6-0 – 12-0



Needle Holder  
Halsey  
ZI-11-637-13  
5"  
mini profile  
for suture material  
size 4-0 – 6-0



Needle Holder  
Crile-Wood  
ZI-11-638-15  
6"  
mini profile  
for suture material  
size 4-0 – 6-0



Needle Holder  
Crile-Wood  
ZI-11-638-20  
8"  
mini profile  
for suture material  
size 4-0 – 6-0



ZI-11-640-18  
7"

for suture material  
size 0-6 – 4-0



ZI-11-640-20  
8"

for suture material  
size 0-6 – 4-0



ZI-11-640-26  
10 1/4"

for suture material  
size 0-6 – 4-0

Needle Holder  
Sarot



Needle Holder  
Mayo-Hegar



ZI-11-642-16  
6 1/4"

for suture material  
size 0-6 – 4-0  
standard profile



ZI-11-642-18  
7"

for suture material  
size 0-6 – 4-0  
standard profile



ZI-11-642-20  
8"

for suture material  
size 0-6 – 4-0  
standard profile



ZI-11-642-24  
9 1/2"

for suture material  
size 0-6 – 4-0  
standard profile



ZI-11-642-26  
10 1/4"

for suture material  
size 0-6 – 4-0  
standard profile



ZI-11-642-30  
11 3/4"

for suture material  
size 0-6 – 4-0  
standard profile



Needle Holder  
Heaney



ZI-11-643-20  
8"  
for suture material  
size 0-6 – 4-0  
standard profile



ZI-11-643-24  
9 1/2"  
for suture material  
size 0-6 – 4-0  
standard profile



ZI-11-643-26  
10 1/4"  
for suture material  
size 0-6 – 4-0  
standard profile



Needle Holder  
DeBakey



ZI-11-646-18  
7"  
for suture material  
size 4-0 – 6-0  
delicate pattern  
mini profile



ZI-11-646-20  
8"  
for suture material  
size 4-0 – 6-0  
delicate pattern  
mini profile



ZI-11-646-23  
9"  
for suture material  
size 4-0 – 6-0  
delicate pattern  
mini profile



ZI-11-646-26  
10 1/4"  
for suture material  
size 4-0 – 6-0  
delicate pattern  
mini profile



ZI-11-646-31  
12 1/4"  
for suture material  
size 4-0 – 6-0  
delicate pattern  
mini profile



**ZARYAB**  
I N S T R U M E N T S

*Products that saves life*

Suture



Needle Holder

Masson

ZI-11-648-27

10 1/2"

for suture material size 0-6 – 4-0





ZI-11-650-13  
5"

for suture material  
size 4-0 – 6-0  
mini profile



ZI-11-650-15  
6"

for suture material  
size 4-0 – 6-0  
mini profile



ZI-11-650-18  
7"

for suture material  
size 4-0 – 6-0  
mini profile



ZI-11-650-20  
8"

for suture material  
size 4-0 – 6-0  
mini profile



ZI-11-650-23  
9"

for suture material  
size 4-0 – 6-0  
mini profile



ZI-11-650-26  
10 1/4"

for suture material  
size 4-0 – 6-0  
mini profile

Needle Holder  
Ryder (Martin)



Needle Holder  
Martin



ZI-11-652-15  
6"  
for suture material  
size 4-0 – 6-0  
mini profileelastic type



ZI-11-652-17  
6 3/4"  
for suture material  
size 4-0 – 6-0  
mini profileelastic type



ZI-11-652-20  
8"  
for suture material  
size 4-0 – 6-0  
mini profileelastic type



**ZARYAB**  
I N S T R U M E N T S

*Products that saves life*

## Suture



Needle Holder  
Finochietto  
ZI-11-653-27  
10 1/2"

for suture material size 0-6 – 4-0



Needle Holder  
Ryder-Vascular



ZI-11-654-13  
5"

for suture material  
size 5-0 – 8-0  
slender pattern  
micro profile



ZI-11-654-15  
6"

for suture material  
size 5-0 – 8-0  
slender pattern  
micro profile



ZI-11-654-18  
7"

for suture material  
size 5-0 – 8-0  
slender pattern  
micro profile



ZI-11-654-20  
8"

for suture material  
size 5-0 – 8-0  
slender pattern  
micro profile



ZI-11-654-23  
8 3/4"

for suture material  
size 5-0 – 8-0  
slender pattern  
micro profile



ZI-11-654-26  
10 1/4"

for suture material  
size 5-0 – 8-0  
slender pattern  
micro profile



**ZARYAB**  
I N S T R U M E N T S

*Products that saves life*

## Suture



Needle Holder

Wangensteen

ZI-11-656-27

10 3/4"

for suture material size 0-6 – 4-0  
standard profile



Needle Holder  
Hegar-Vascular



ZI-11-658-14  
5 1/2"  
for suture material  
size 5-0 – 8-0  
micro profile



ZI-11-658-18  
7 1/4"  
for suture material  
size 5-0 – 8-0  
micro profile



ZI-11-658-20  
8"  
for suture material  
size 5-0 – 8-0  
micro profile

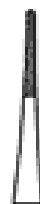

ZI-11-658-23  
9"  
for suture material  
size 5-0 – 8-0  
micro profile



Needle Holder  
Bozemann



ZI-11-659-20  
8"  
for suture material  
size 0-6 – 4-0  
standard profile



ZI-11-659-24  
9 1/2"  
for suture material  
size 0-6 – 4-0  
standard profile

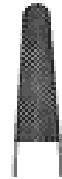

ZI-11-659-26  
10 1/2"  
for suture material  
size 0-6 – 4-0  
standard profile

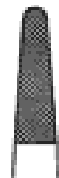

ZI-11-659-28  
11 1/2"  
for suture material  
size 0-6 – 4-0  
standard profile



ZI-11-662-20  
8"  
for suture material  
size 0-6 – 4-0  
standard profile



ZI-11-662-24  
9 1/4"  
for suture material  
size 0-6 – 4-0  
standard profile

Needle Holder  
Hegar





Needle Holder  
Stratte



ZI-11-665-22  
9"

for suture material  
size 0-6 – 4-0  
standard profile



ZI-11-665-23  
9"

for suture material  
size 0-6 – 4-0  
standard profile



Needle Holder  
Microvascular

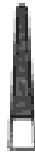

HIM-11-666-00  
5 1/2"  
for suture material  
size 5-0 – 8-0  
slender pattern  
micro profile



HIM-11-666-02  
7"  
for suture material  
size 5-0 – 8-0  
slender pattern  
micro profile



ZI-11-666-03  
8"  
for suture material  
size 5-0 – 8-0  
slender pattern  
micro profile



ZI-11-666-04  
9"  
for suture material  
size 5-0 – 8-0  
slender pattern  
micro profile



Needle Holder  
Martini



ZI-11-668-00  
5 1/2"

for suture material  
size 6-0 – 12-0  
slender pattern  
smooth jaw



ZI-11-668-01  
6 1/4"

for suture material  
size 6-0 – 12-0  
slender pattern  
smooth jaw



ZI-11-668-02  
7"

for suture material  
size 6-0 – 12-0  
slender pattern  
smooth jaw



ZI-11-668-03  
8"

for suture material  
size 6-0 – 12-0  
slender pattern  
smooth jaw



ZI-11-670-00  
5 1/2"

for suture material  
size 6-0 – 12-0  
slender pattern  
smooth jaw



ZI-11-670-01  
6 1/4"

for suture material  
size 6-0 – 12-0  
slender pattern  
smooth jaw



ZI-11-670-02  
7"

for suture material  
size 6-0 – 12-0  
slender pattern  
smooth jaw



ZI-11-670-03  
8"

for suture material  
size 6-0 – 12-0  
slender pattern  
smooth jaw



Needle Holder  
Olsen-Hegar



ZI-11-672-14  
5 3/4"  
for suture material  
size 0-6 – 4-0  
standard profile



ZI-11-672-17  
6 3/4"  
for suture material  
size 0-6 – 4-0  
standard profile



ZI-11-672-18  
7 1/2"  
for suture material  
size 0-6 – 4-0  
standard profile



Needle Holder  
Foster-Gillies  
ZI-11-673-11  
4 1/4"  
smooth jaw  
for suture material  
size 6-0 – 12-0



Needle Holder  
Foster-Gillies  
ZI-11-673-11  
4 1/4"  
smooth jaw  
for suture material  
size 6-0 – 12-0



Needle Holder  
Gillies-Mini  
ZI-11-673-15  
6"  
mini profile  
for suture material  
size 4-0 – 6-0



Needle Holder  
Gillies  
ZI-11-673-16  
6 1/4"  
for suture  
material size 0-6 – 4-0  
standard profile



Needle Holder  
Mathieu  
ZI-11-674-14  
5 1/2"

for suture material  
size 0-6 – 4-0  
standard profile



Needle Holder  
Mathieu  
ZI-11-674-17  
6 3/4"

for suture material  
size 0-6 – 4-0  
standard profile



Needle Holder  
Mathieu  
ZI-11-674-20  
8"

for suture material  
size 0-6 – 4-0  
standard profile



Needle Holder  
Mathieu  
ZI-11-676-14  
5 1/2"  
for suture material  
size 0-6 – 4-0  
standard profile



Needle Holder  
Mathieu  
ZI-11-676-17  
6 3/4"  
for suture material  
size 0-6 – 4-0  
standard profile



Needle Holder  
Mathieu  
ZI-11-676-20  
8"  
for suture material  
size 0-6 – 4-0  
standard profile



Needle Holder  
Mathieu  
ZI-11-678-17  
6 3/4"  
for suture material  
size 0-6 – 4-0  
standard profile  
with interior ratchet

Needle Holder  
Mathieu  
ZI-11-678-20  
8"  
for suture material  
size 0-6 – 4-0  
standard profile  
with interior ratchet

Needle Holder  
Mathieu  
ZI-11-678-23  
9"  
for suture material  
size 0-6 – 4-0  
standard profile  
with interior ratchet





Needle Holder

Toennis

ZI-11-684-18

7 1/4"

for suture material  
size 0-6 – 4-0  
standard profile

Needle Holder

Lichtenberg

ZI-11-686-20

8"

for suture material  
size 0-6 – 4-0  
lightweight model  
standard profile



Needle Holder  
Langenbeck  
ZI-11-692-18  
7"

for suture material  
size 0-6 – 4-0  
standard profile



Needle Holder  
Langenbeck  
ZI-11-692-20  
8"

for suture material  
size 0-6 – 4-0  
standard profile



Needle Holder  
Langenbeck  
ZI-11-692-23  
9"

for suture material  
size 0-6 – 4-0  
standard profile



Needle Holder  
Zweifel  
ZI-11-696-20  
8"

for suture material size 0-6 – 4-0  
with hinged ratchet standard profile

Needle Holder  
Zweifel  
ZI-11-696-23  
9"

for suture material size 0-6 – 4-0  
with hinged ratchet standard profile



Reverdin Needle  
Reverdin  
ZI-11-701-15  
5 3/4"  
Fig. 1  
short



Reverdin Needle  
Reverdin  
ZI-11-702-15  
5 3/4"  
Fig. 2  
short



Reverdin Needle  
Reverdin  
ZI-11-703-15  
5 3/4"  
Fig. 3  
short



Reverdin Needle  
Reverdin  
ZI-11-704-15  
5 3/4"  
Fig. 4  
short

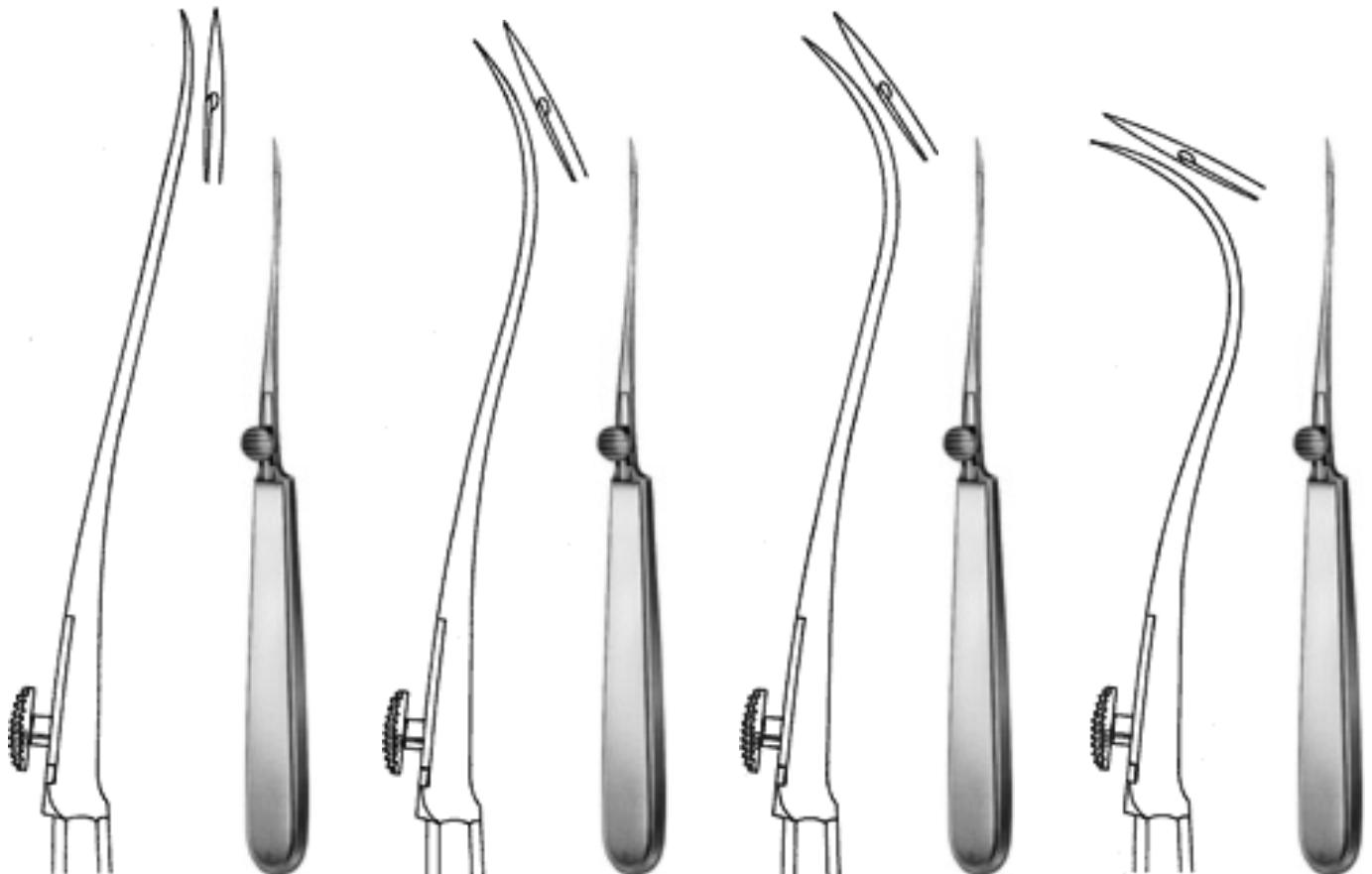

Reverdin Needle  
Reverdin  
ZI-11-721-19  
7 3/4"  
Fig. 1  
short

Reverdin Needle  
Reverdin  
ZI-11-722-19  
7 3/4"  
Fig. 2  
short

Reverdin Needle  
Reverdin  
ZI-11-723-19  
7 3/4"  
Fig. 3  
short

Reverdin Needle  
Reverdin  
ZI-11-724-19  
7 3/4"  
Fig. 4  
short

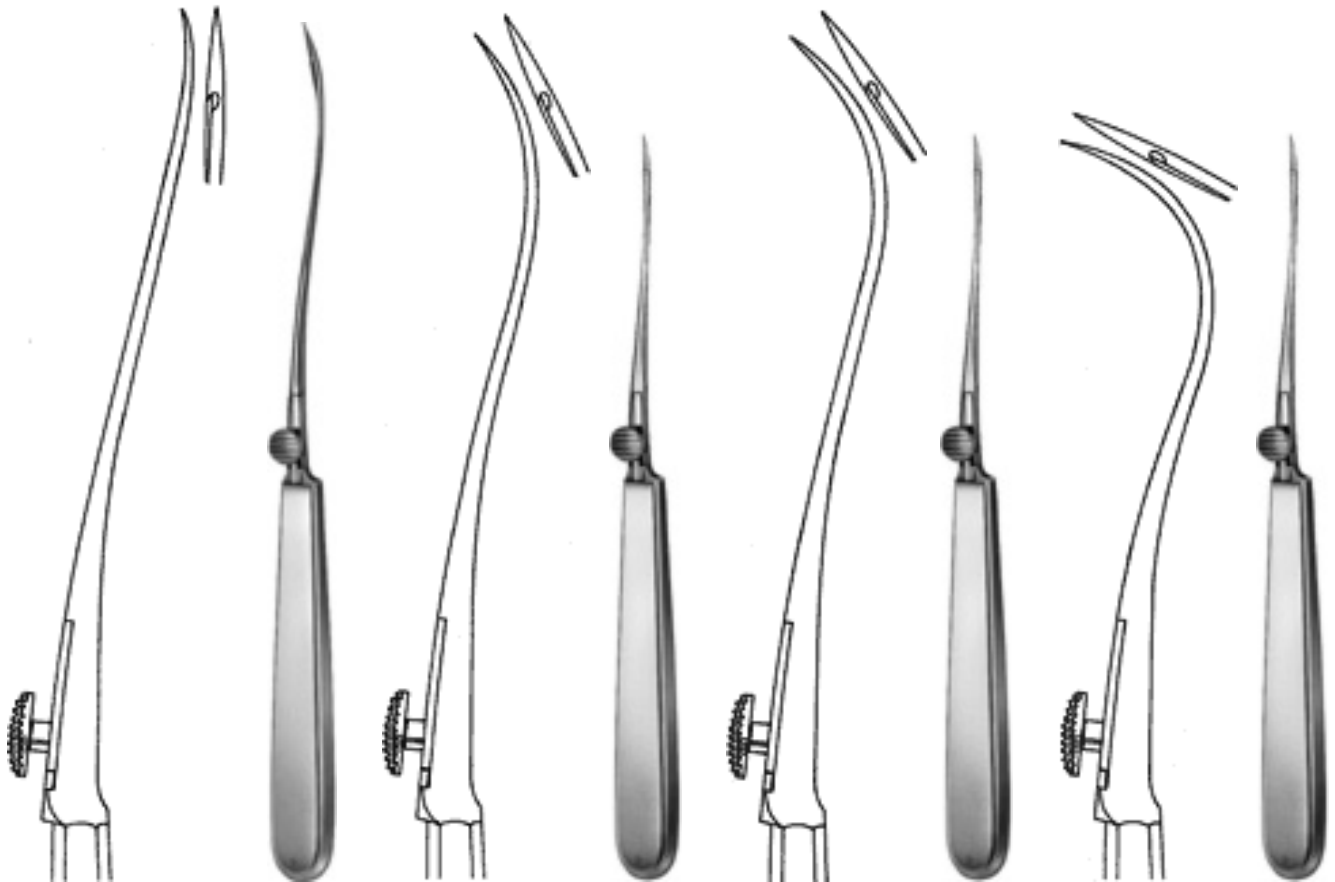

Reverdin Needle  
Reverdin  
ZI-11-741-23  
9"  
Fig. 1  
short

Reverdin Needle  
Reverdin  
ZI-11-742-23  
9"  
Fig. 2  
short

Reverdin Needle  
Reverdin  
ZI-11-743-23  
9"  
Fig. 3  
short

Reverdin Needle  
Reverdin  
ZI-11-744-23  
9"  
Fig. 4  
short



Needle Holder  
Young  
ZI-11-775-25  
9 3/4"



Spare Needle  
Young  
ZI-11-776-01  
Fig. 1



Spare Needle  
Young  
ZI-11-776-02  
Fig. 2



Spare Needle  
Young  
ZI-11-776-03  
Fig. 3

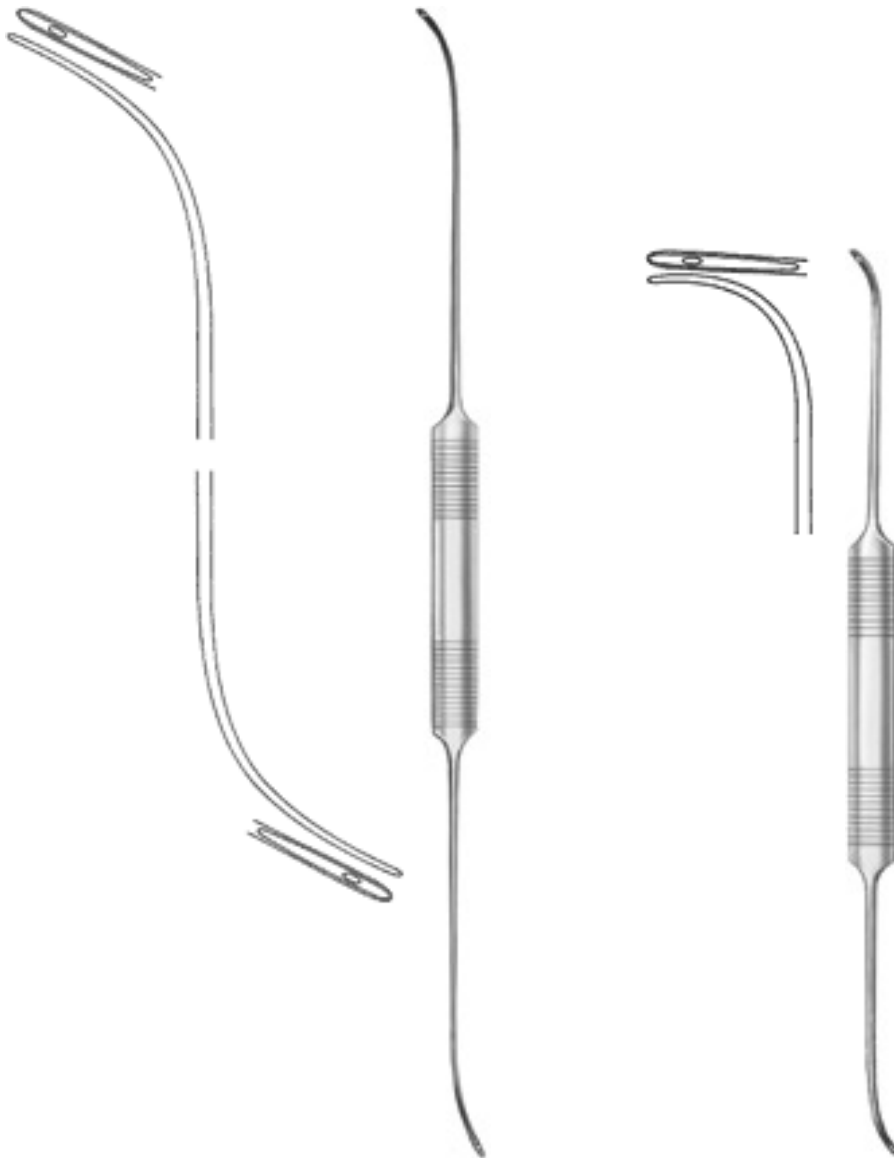

Ligature Needle  
Schmieden-Dick  
ZI-11-813-32  
11 1/2"

Ligature Needle  
Schmieden  
ZI-11-815-21  
9 1/2"





**ZARYAB**  
I N S T R U M E N T S

*Products that saves life*

## Suture



Ligature Needle  
ZI-11-825-20  
8"  
malleable



Ligature Needle  
Cooper  
ZI-11-832-19  
7 1/4"



**ZARYAB**  
I N S T R U M E N T S

*Products that saves life*

## Suture



Ligature Needle  
Kronecker  
ZI-11-835-13  
5"  
delicatefor right hand

Ligature Needle  
Kronecker  
ZI-11-837-13  
5"  
delicatefor right hand



**ZARYAB**  
I N S T R U M E N T S

*Products that saves life*

## Suture



Ligature Needle  
Deschamps  
ZI-11-839-24  
9 1/2"  
bluntfor right hand

Ligature Needle  
Deschamps  
ZI-11-840-24  
9 1/2"  
bluntfor left hand



## Suture

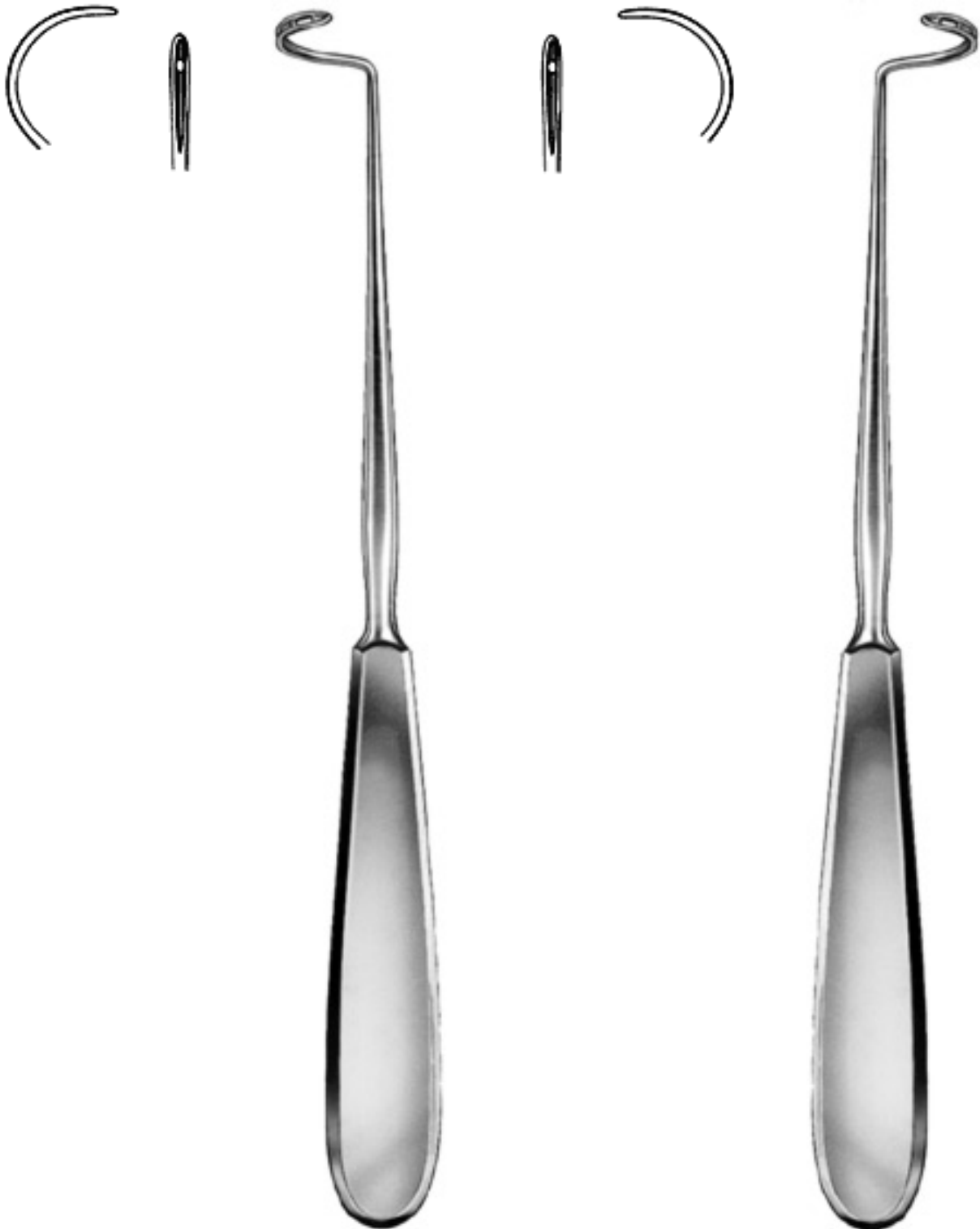

Ligature Needle  
Deschamps  
ZI-11-841-20  
8"  
blunt  
for right hand

Ligature Needle  
Deschamps  
ZI-11-842-20  
8"  
blunt  
for left hand

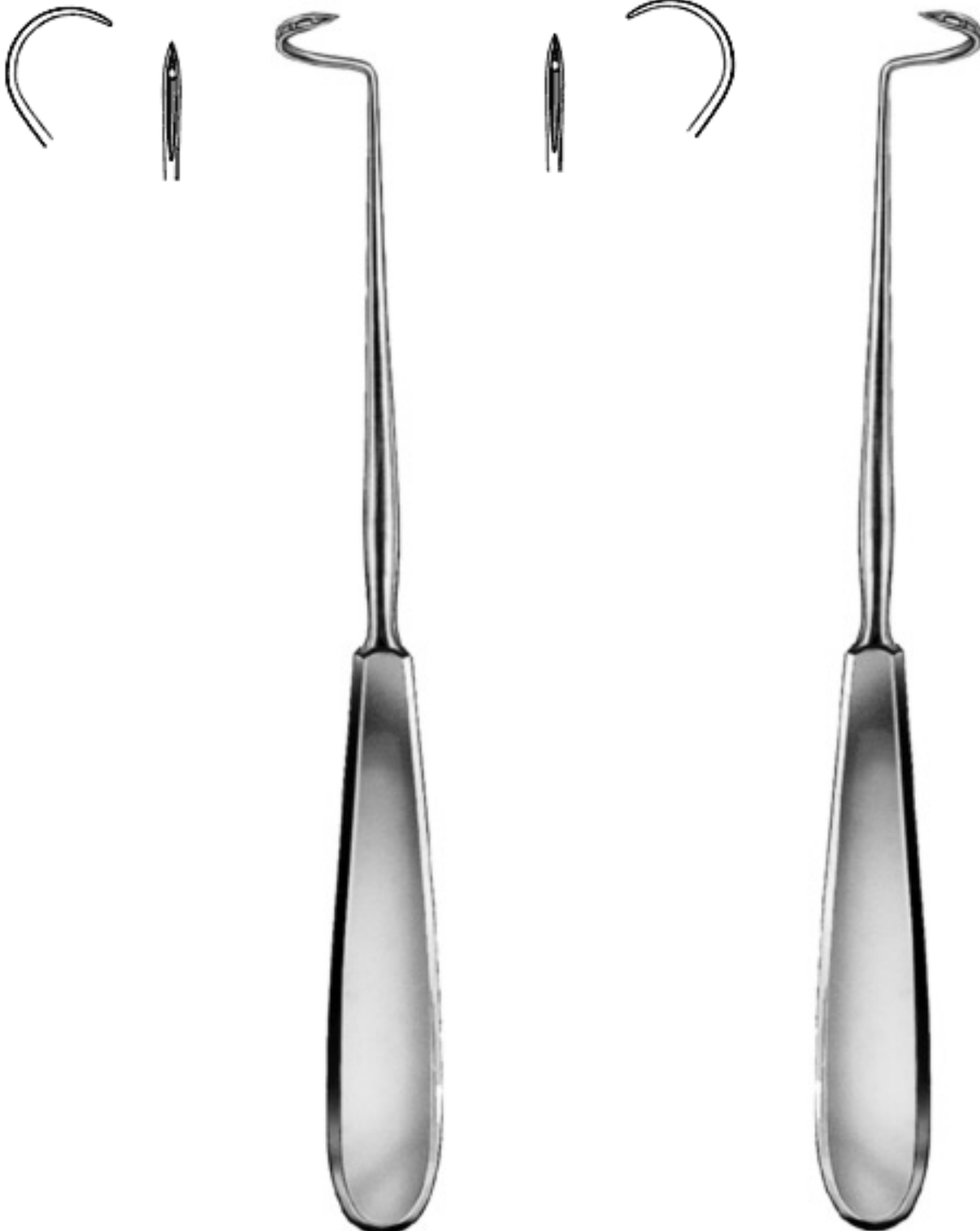

Ligature Needle  
Deschamps  
ZI-11-843-20  
8"  
sharp  
for right hand

Ligature Needle  
Deschamps  
ZI-11-844-20  
8"  
sharp  
for left hand



## Suture

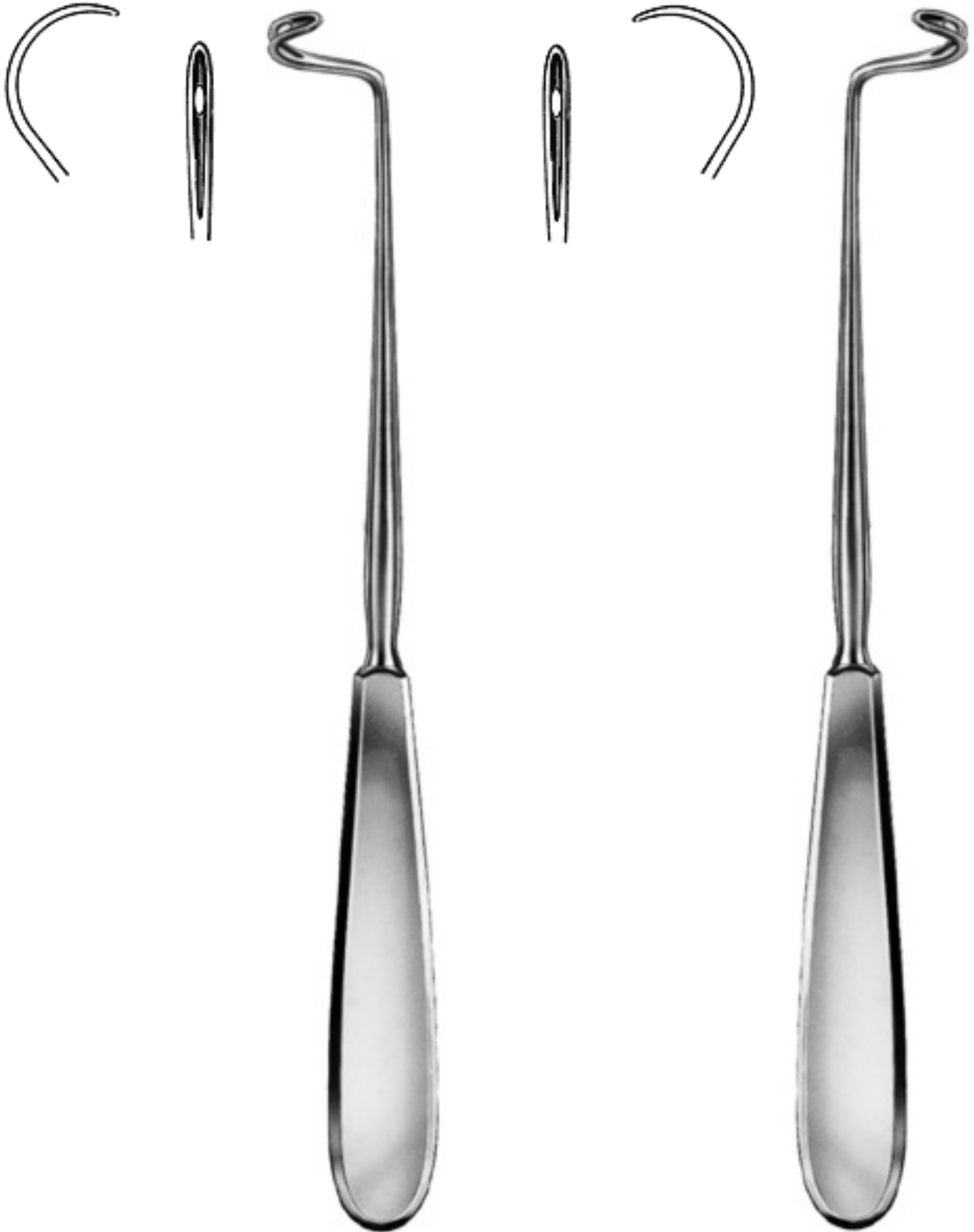

Ligature Needle  
Deschamps  
ZI-11-845-21  
8"  
blunt  
for right hand

Ligature Needle  
Deschamps  
ZI-11-846-21  
8"  
blunt  
for left hand



## Suture



Ligature Needle  
Deschamps  
ZI-11-847-21  
8"  
sharp  
for right hand



Ligature Needle  
Deschamps  
ZI-11-848-21  
8"  
sharp  
for left hand

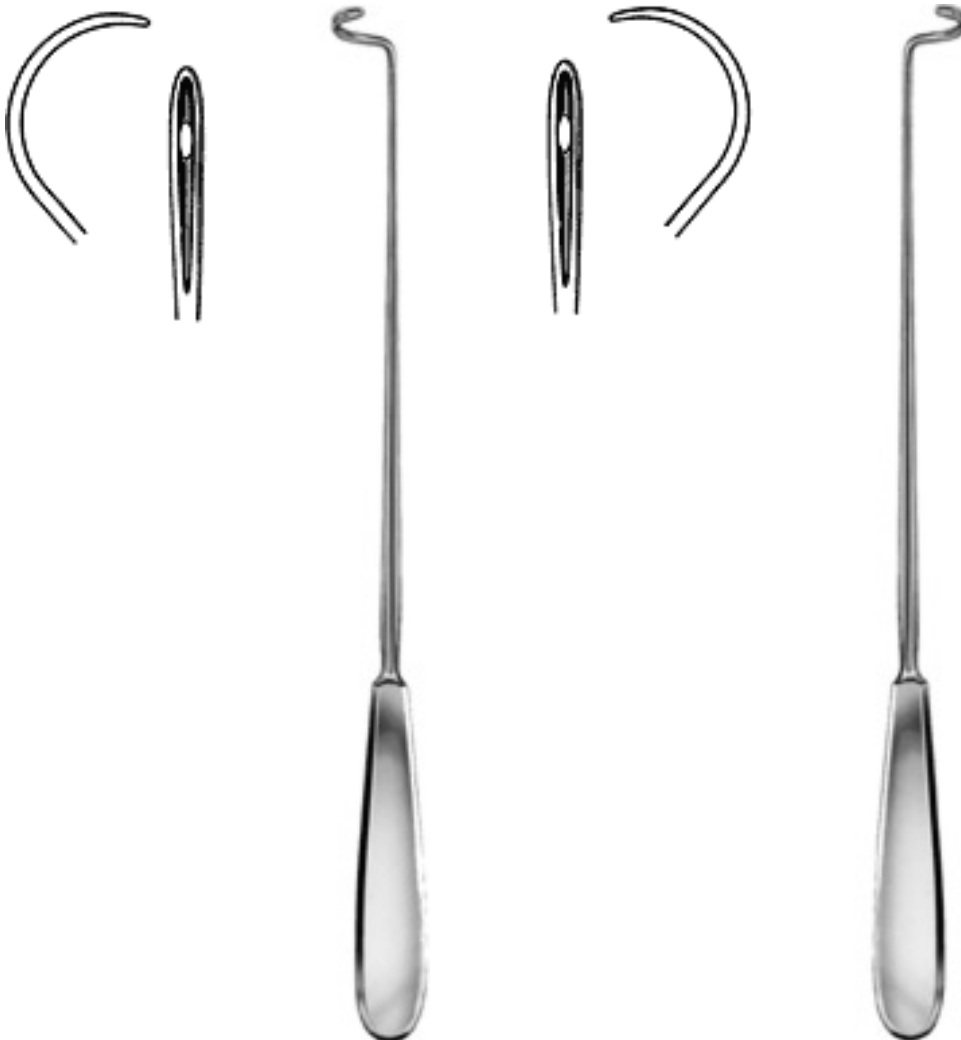

Ligature Needle  
Deschamps  
ZI-11-849-27  
10 1/2"  
sharp  
for right hand

Ligature Needle  
Deschamps  
ZI-11-850-27  
10 1/2"  
blunt  
for right hand



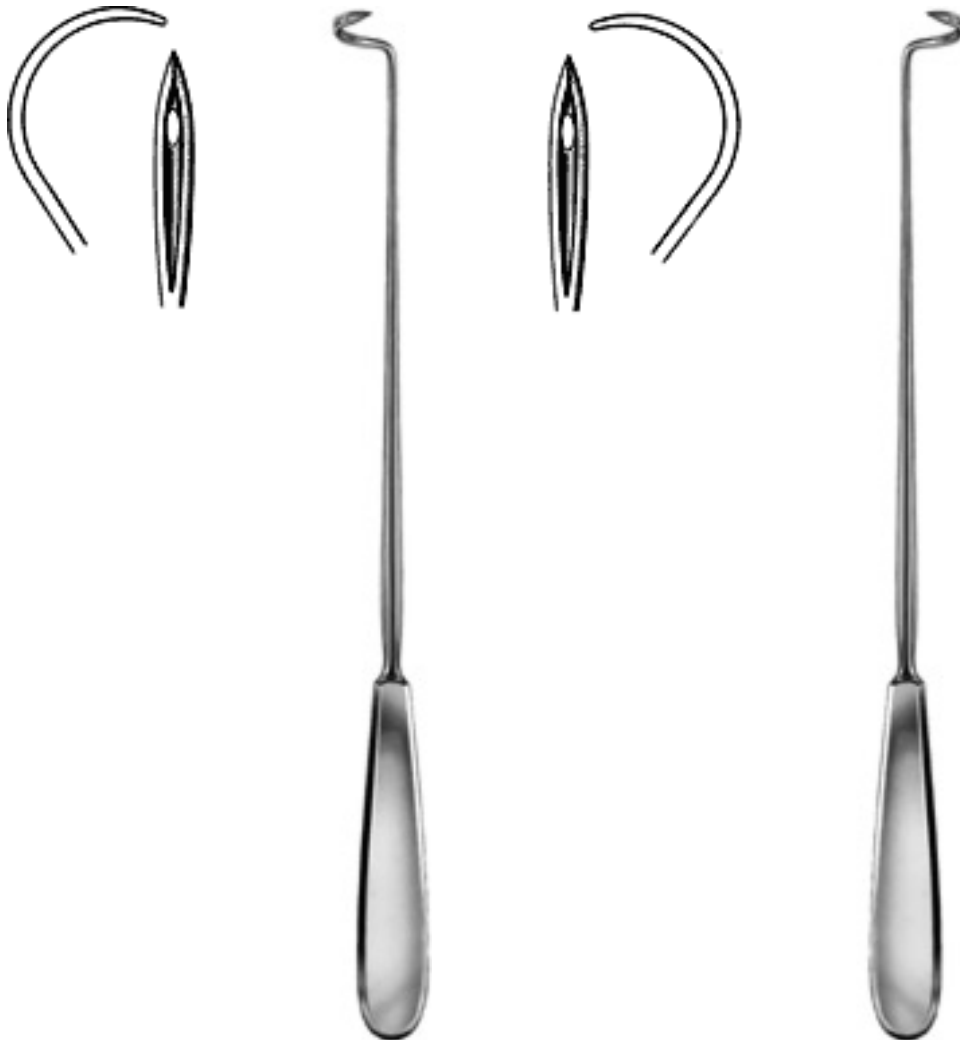

Ligature Needle  
Deschamps  
ZI-11-851-27  
10 ½"  
sharp  
for right hand

Ligature Needle  
Deschamps  
ZI-11-852-27  
10 ½"  
sharp  
for right hand

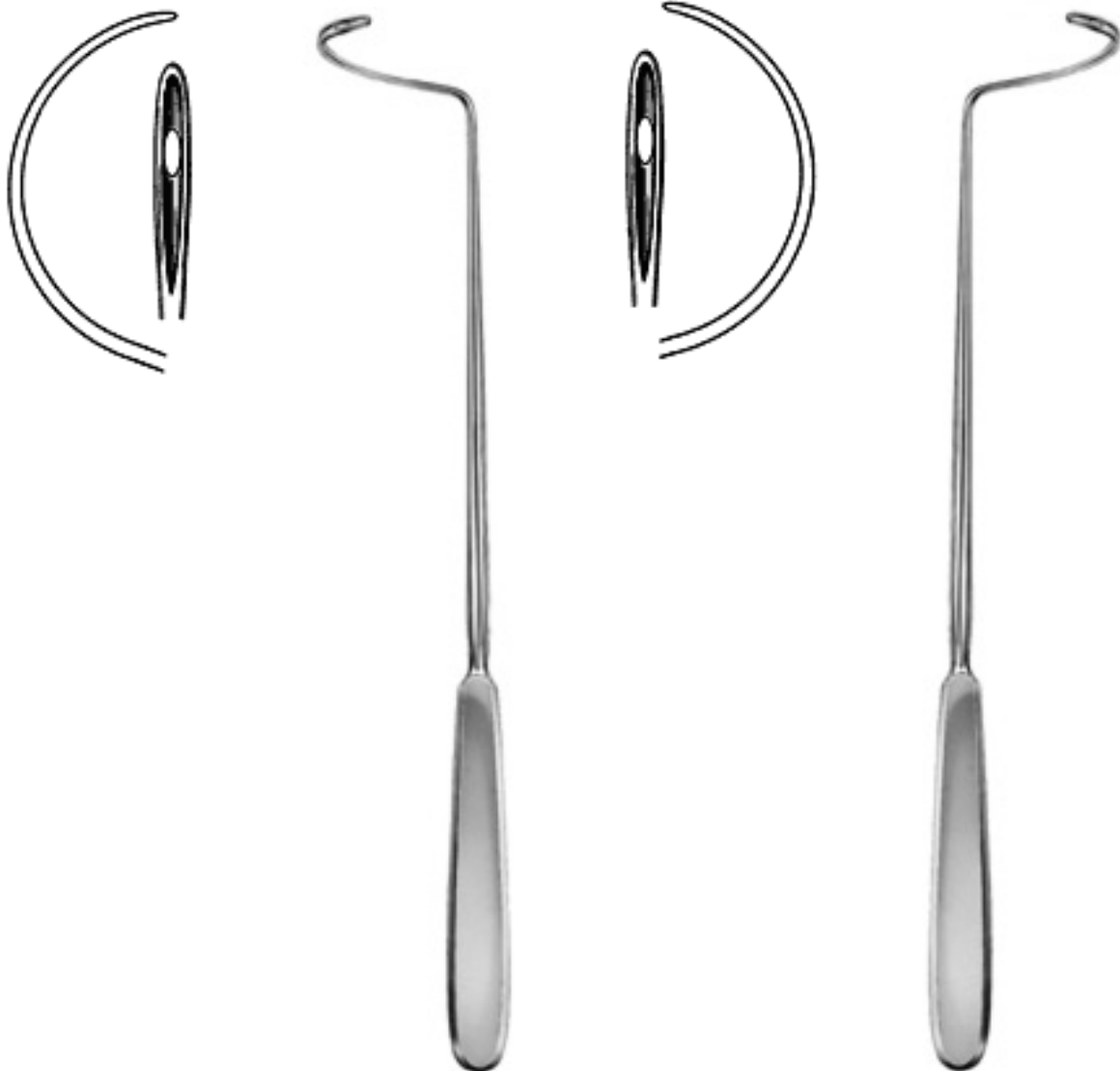

Ligature Needle  
Deschamps  
ZI-11-853-28  
11"  
blunt  
for right hand

Ligature Needle  
Deschamps  
ZI-11-854-28  
11"  
blunt  
for right hand

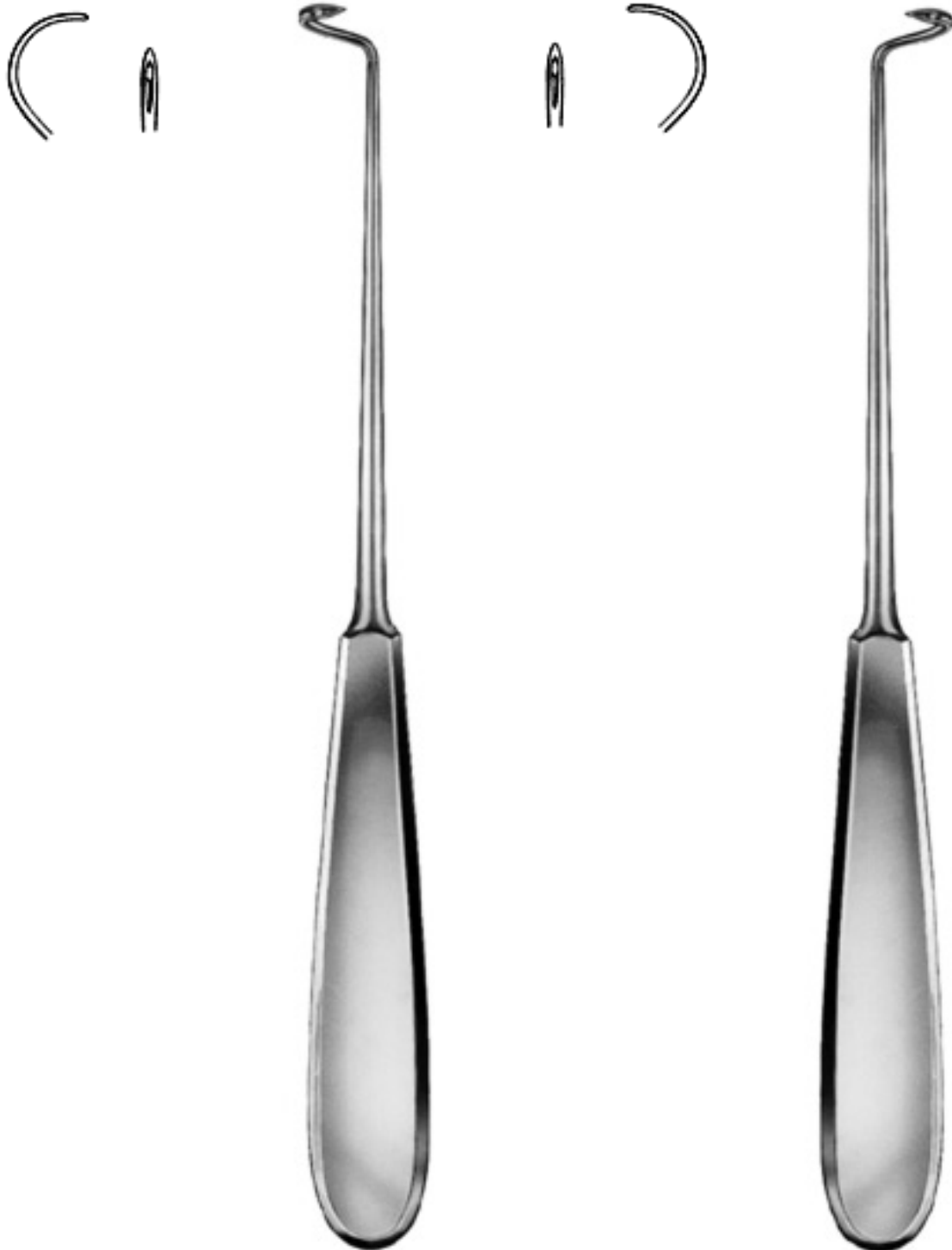

Ligature Needle  
Deschamps  
ZI-11-855-20  
8"  
sharp  
for right hand

Ligature Needle  
Deschamps  
ZI-11-856-20  
8"  
sharp  
for right hand

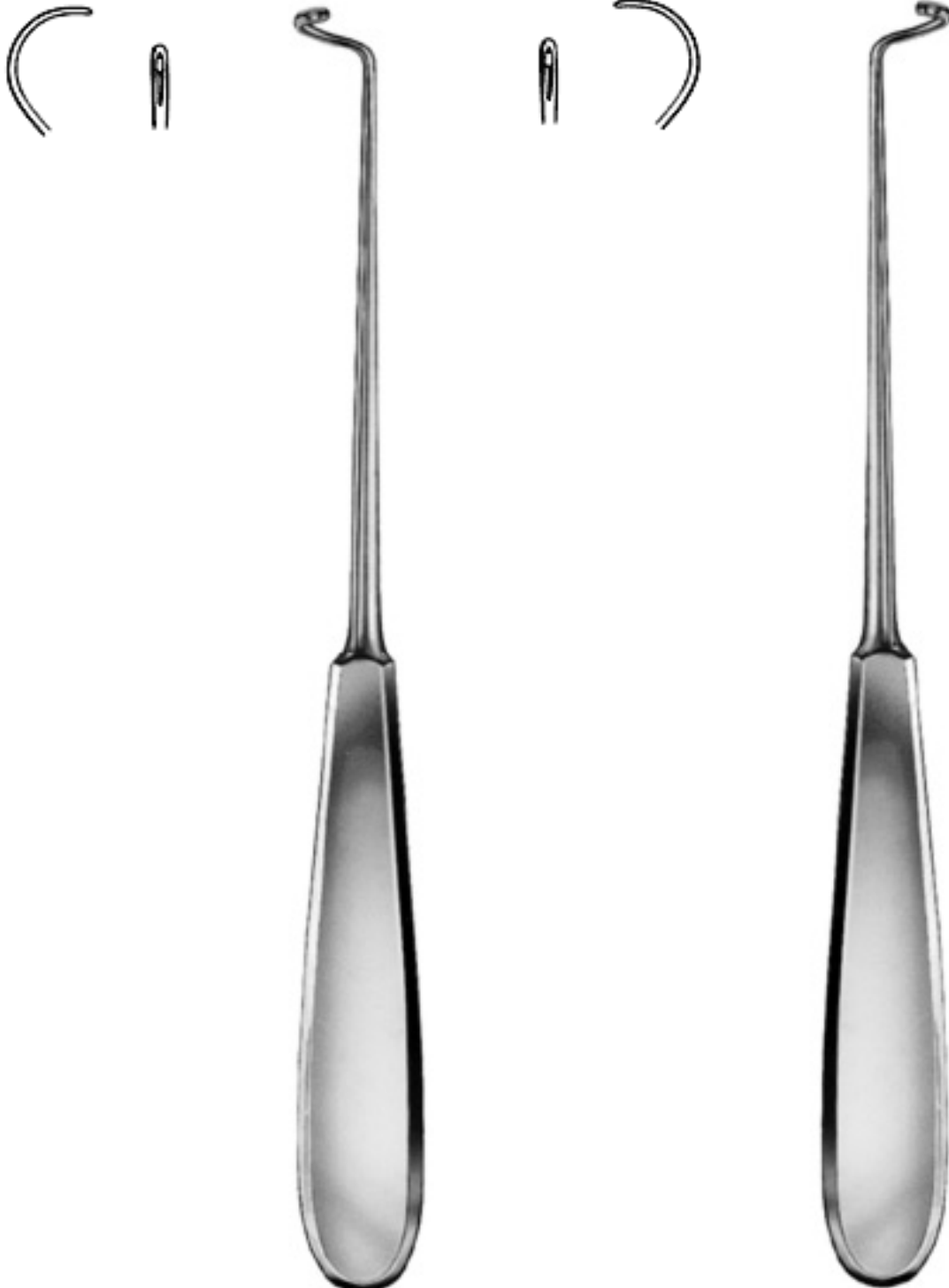

Ligature Needle  
Deschamps  
ZI-11-857-20  
8"  
blunt  
for right hand

Ligature Needle  
Deschamps  
ZI-11-858-20  
8"  
blunt  
for left hand

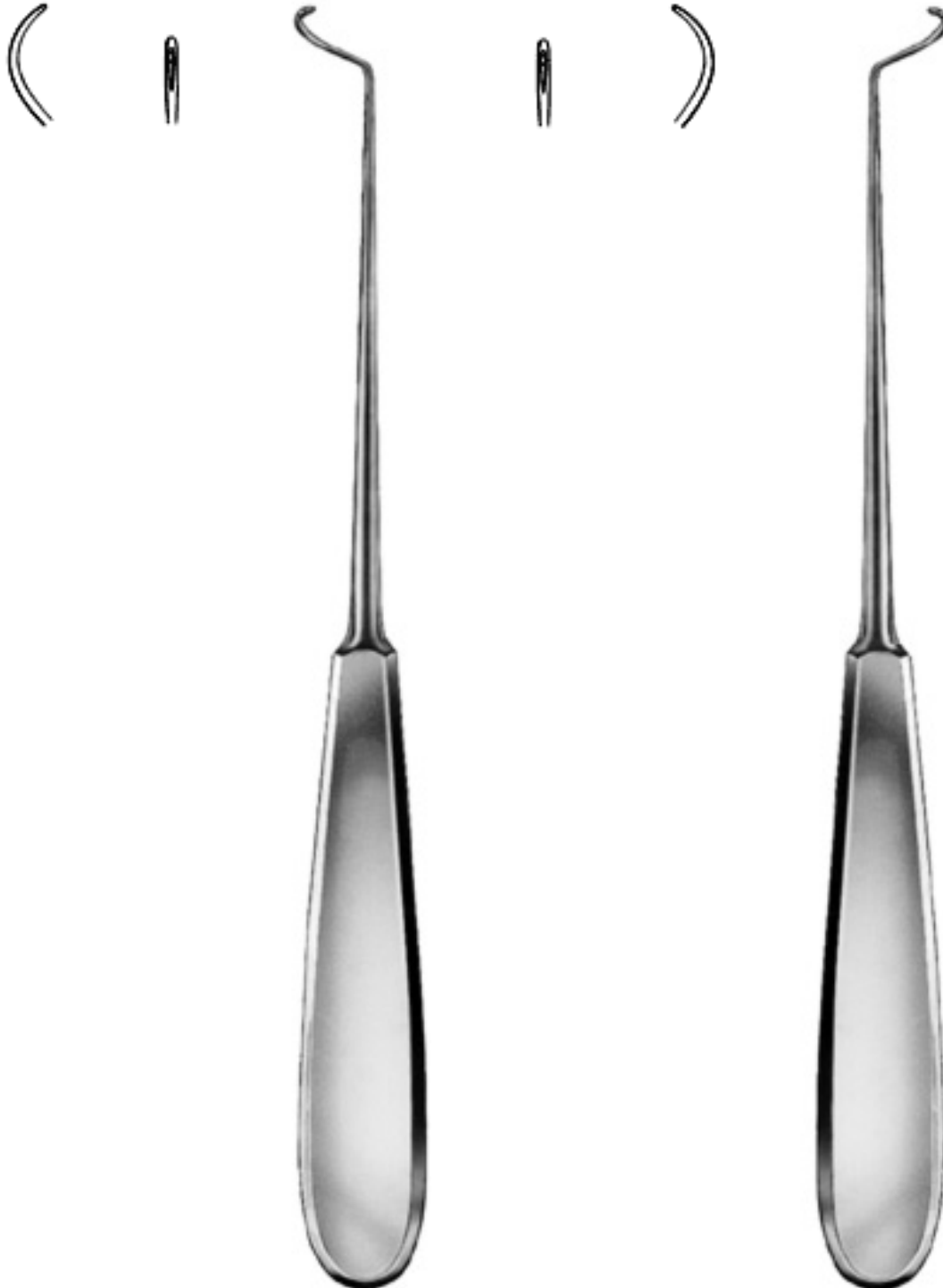

Ligature Needle  
Deschamps  
ZI-11-859-20  
8 1/4"  
blunt  
for right hand

Ligature Needle  
Deschamps  
ZI-11-860-20  
8 1/4"  
blunt  
for left hand

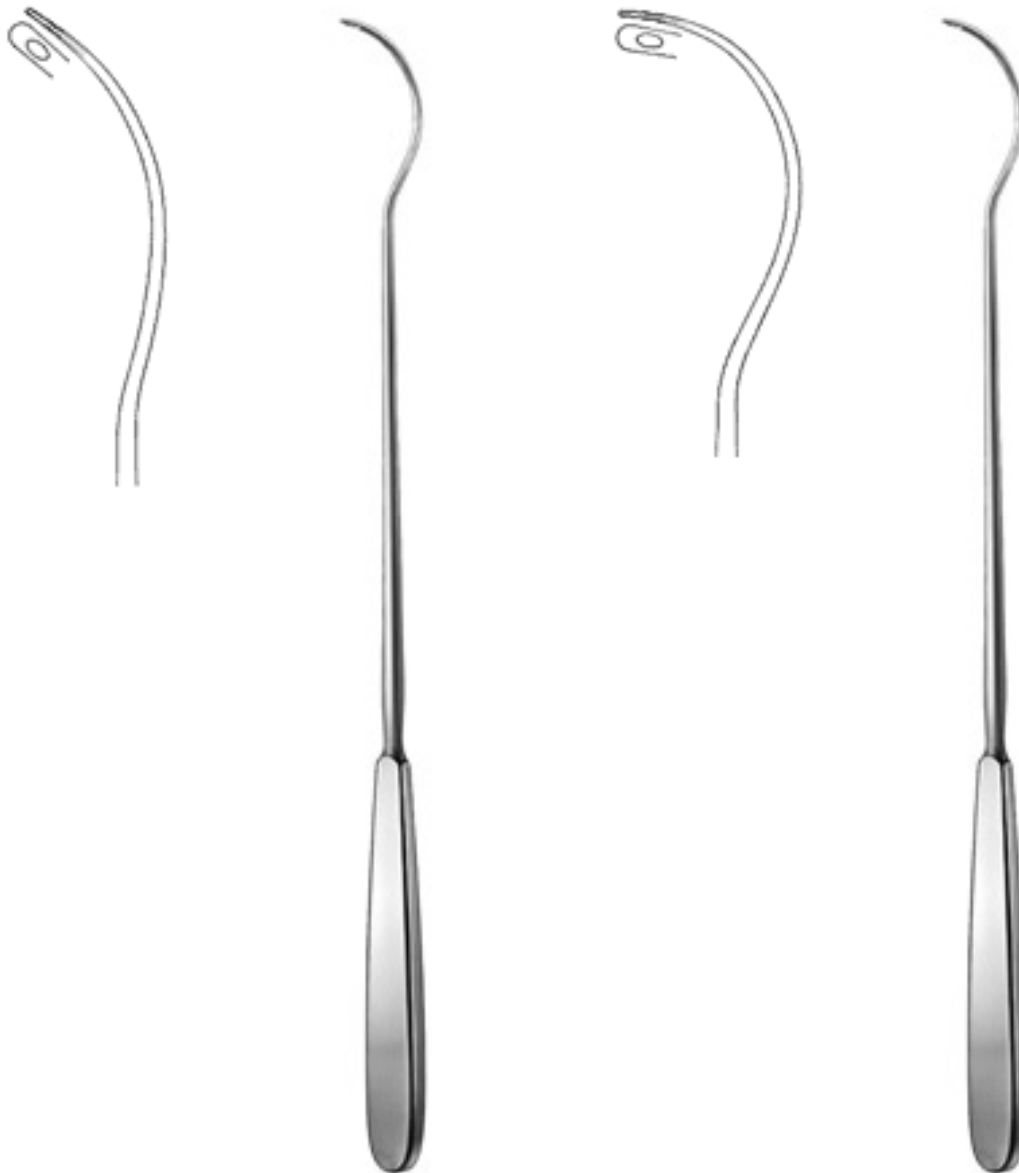

Ligature Needle  
Brunner  
ZI-11-861-30  
12"

Ligature Needle  
Brunner  
ZI-11-862-30  
11 3/4"



**ZARYAB**  
INSTRUMENTS

*Products that saves life*

## Suture

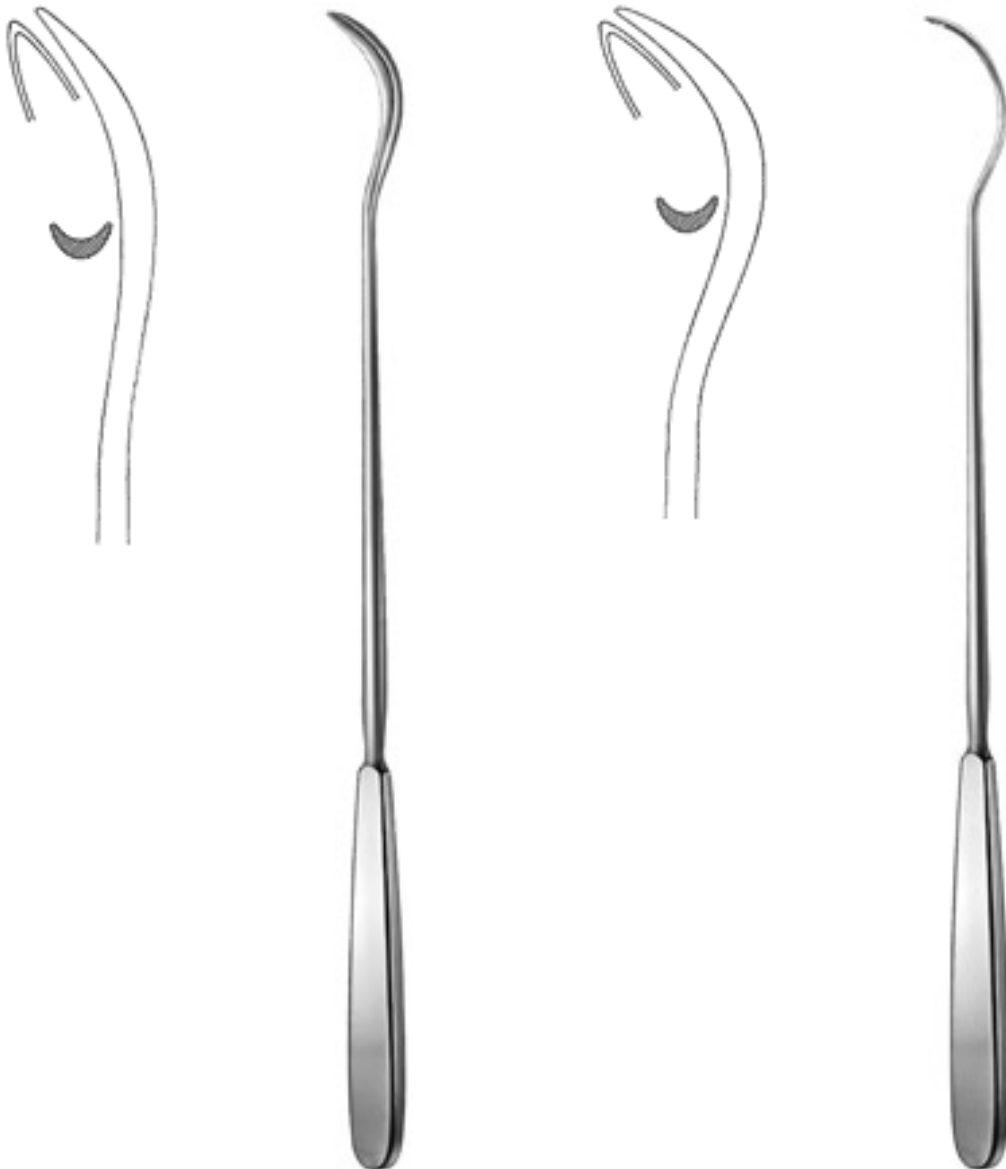

Ligature Needle  
Brunner  
ZI-11-863-30  
12"

Ligature Needle  
Brunner  
ZI-11-864-30  
11 3/4"

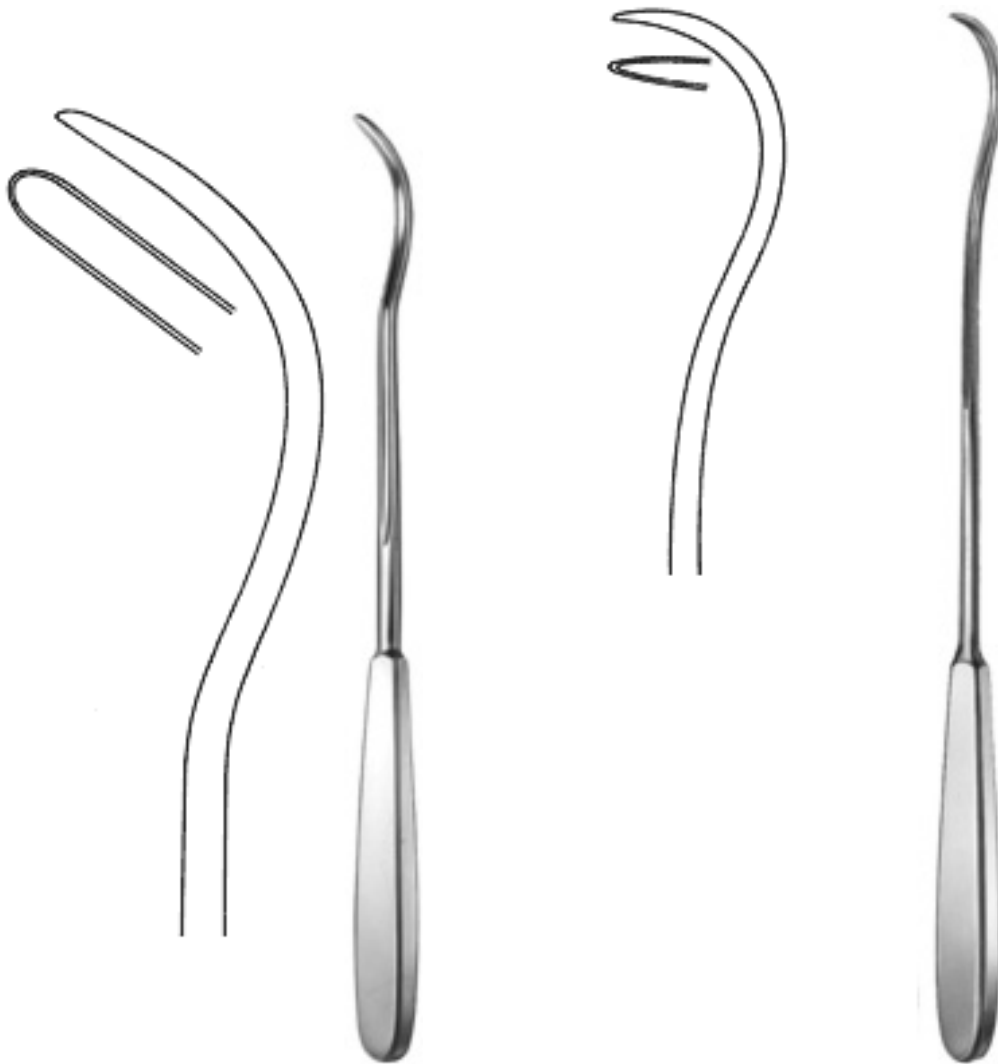

Ligature Needle  
Kirschner  
ZI-11-865-25  
10"

Ligature Needle  
ZI-11-866-28  
11"





Ligature Conductor  
Martin  
ZI-11-867-25  
7 3/4"



Ligature Conductor  
Brunner  
ZI-11-868-18  
7"  
of plastic material  
(Ferrozell)



Ligature Conductor  
Kirschner  
ZI-11-869-27  
10 3/4"  
of plastic material  
(Ferozell)

Ligature Conductor  
ZI-11-870-01  
7 1/2"

Ligature Conductor  
ZI-11-870-19  
7 1/4"

Ligature Conductor  
ZI-11-870-24  
9 1/2"



Ligature Conductor  
Schmieden  
ZI-11-871-19  
7"



Ligature Conductor  
Schmieden-Payr  
ZI-11-872-19  
7"  
with hole at the tip



**ZARYAB**  
INSTRUMENTS

*Products that saves life*

## Suture

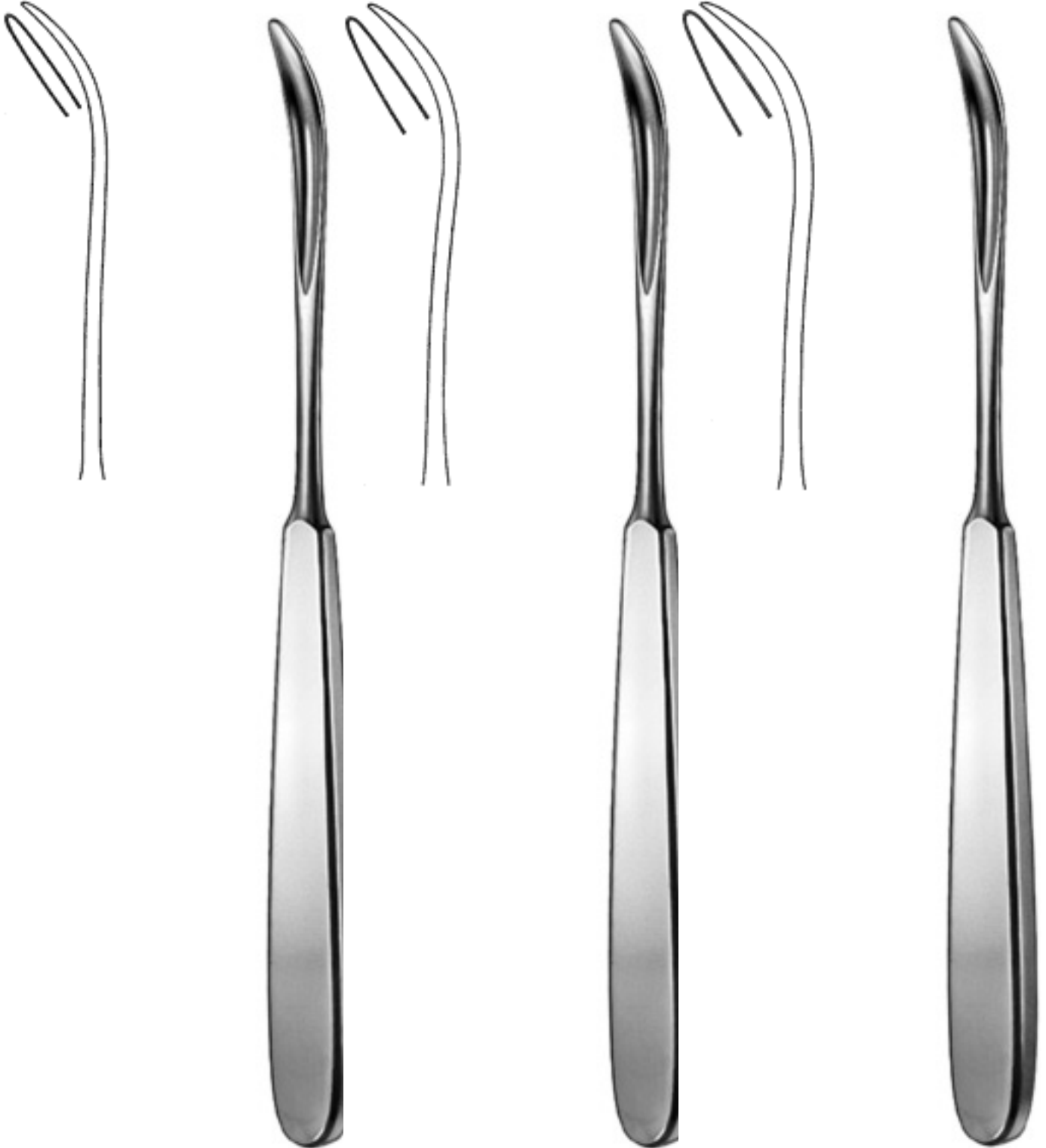

Ligature Conductor  
König  
ZI-11-875-03  
7 3/4"

Ligature Conductor  
König  
ZI-11-875-05  
7 3/4"

Ligature Conductor  
König  
ZI-11-875-07  
7 3/4"



**ZARYAB**  
I N S T R U M E N T S

*Products that saves life*

## Suture



Ligature Conductor  
Payr  
ZI-11-877-22  
8 3/4"

Ligature Conductor  
Payr  
ZI-11-878-22  
8 3/4"





Ligature Catcher  
Modell Wien  
ZI-11-882-23  
9 1/4"  
Ligature Catcher



Knot Tier  
Bozemann  
ZI-11-884-21  
8 1/4"  
Knot Tier



Ligature Adjuster  
ZI-11-886-23  
9"  
Ligature Adjuster



Approximation Forceps  
Childe  
ZI-11-910-18  
7"  
Approximation Forceps  
heavy pattern, with clip holder



Clip Applying Forceps  
Michel  
ZI-11-916-12  
4 3/4"



Clip Applying Forceps  
Hegenbarth  
ZI-11-922-12  
4 3/4"



Clip Applying Forceps  
Wachenfeldt  
ZI-11-924-12  
4 3/4"



Clip Applying Forceps  
Michel  
ZI-11-928-12  
5"



**ZARYAB**  
I N S T R U M E N T S

*Products that saves life*

Suture



Clip Applying Forceps  
Michel  
ZI-11-929-12  
5"





**ZARYAB**  
INSTRUMENTS

*Products that saves life*

## Suture



Clip Applying Forceps  
Collin  
ZI-11-934-13  
5"



Clip Applying Forceps  
Richter  
ZI-11-935-14  
5 1/4"



ZI-11-940-01  
7,5 x 1,75 mm  
unit for sale = 1000 pieces  
(10 packages with 100 each)



ZI-11-940-06  
16 x 3,0 mm  
unit for sale = 1000 pieces  
(10 packages with 100 each)



ZI-11-940-02  
11 x 2,0 mm  
unit for sale = 1000 pieces  
(10 packages with 100 each)



ZI-11-940-07  
18 x 3,0 mm  
unit for sale = 1000 pieces  
(10 packages with 100 each)



ZI-11-940-04  
12 x 3,0 mm  
unit for sale = 1000 pieces  
(10 packages with 100 each)



ZI-11-940-08  
20 x 3,0 mm  
unit for sale = 1000 pieces  
(10 packages with 100 each)

Suture Clip  
Michel



ZI-11-940-05  
14 x 3,0 mm  
unit for sale = 1000 pieces  
(10 packages with 100 each)



ZI-11-940-09  
22 x 3,0 mm  
unit for sale = 1000 pieces  
(10 packages with 100 each)



**ZARYAB**  
I N S T R U M E N T S

*Products that saves life*

Suture



Suture Clip Set

Martin

ZI-11-952-00

130 x 45 x 18 mm

complete in metal case and plastic pouch



**ZARYAB**  
I N S T R U M E N T S

*Products that saves life*

Suture



Suture Set  
Martin  
ZI-11-959-00

complete in metal case and plastic pouch 165 x 90 x 20 mm



**ZARYAB**  
I N S T R U M E N T S

*Products that saves life*

Suture



Suture Set  
Martin  
ZI-11-962-00

complete in metal case and plastic pouch instruments with box-lock 165 x 90 x 28 mm



**ZARYAB**  
I N S T R U M E N T S

*Products that saves life*

Suture



Suture Set  
Martin  
ZI-11-965-00

complete in metal case and plastic pouch 200 x 100 x 27 mm



**ZARYAB**  
I N S T R U M E N T S

*Products that saves life*

Suture



Venae sectio Set  
Venaesectio  
ZI-11-968-00

complete in metal case and plastic pouch 200 x 100 x 32 mm



**ZARYAB**  
INSTRUMENTS

*Products that saves life*

Suture



"Small Suture" Set  
ZI-11-970-00





**ZARYAB**  
I N S T R U M E N T S

*Products that saves life*

Suture



"Small Suture" Set  
ZI-11-971-00



*Products that saves life*

# ZARYAB

---

## I N S T R U M E N T S

 Harar, Wazirabad Road, Pir Sabz Rd, Pir Sabz, Sialkot-51310, Pakistan

 +92 52 3573775

 +92 52 3573776

 +92 333 8608580 , +92 333 3349600

 [info@zaryabinstruments.com](mailto:info@zaryabinstruments.com)

 [sales@zaryabinstruments.com](mailto:sales@zaryabinstruments.com)

 [www.zaryabinstruments.com](http://www.zaryabinstruments.com)