

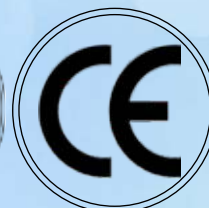

Products that saves life

ZARYAB

INSTRUMENTS



RETRACTORS

Catalogue





Retractor



Skin Hooklet
Vickers
ZI-06-001-18
7 1/4"



Bone Hooklet Tendon Hooklet
ZI-06-006-01 ZI-15-011-01
6 3/4" 6 3/4"

Vickers



Vickers
ZI-06-021-02
6 1/4"

Vickers
ZI-06-021-03
6 1/4"

Hooklet



Retractor

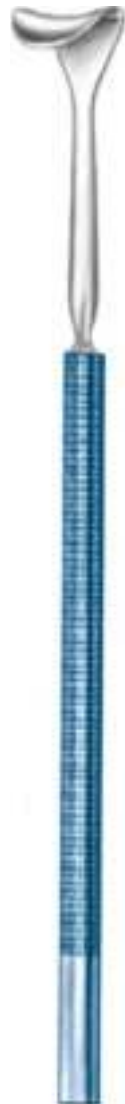
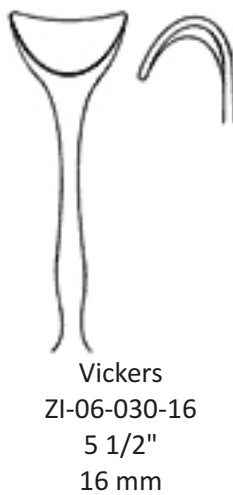
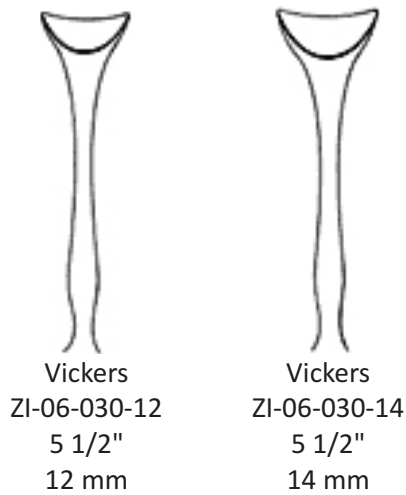

Saddle Hook



Micro Hooklet



ZI-06-068-01
6 1/4"
Fig. 1



ZI-06-068-02
6 1/4"
Fig. 2



ZI-06-068-03
6 1/4"
Fig. 3



ZI-06-068-04
6 1/4"
Fig. 4



Skin Hook

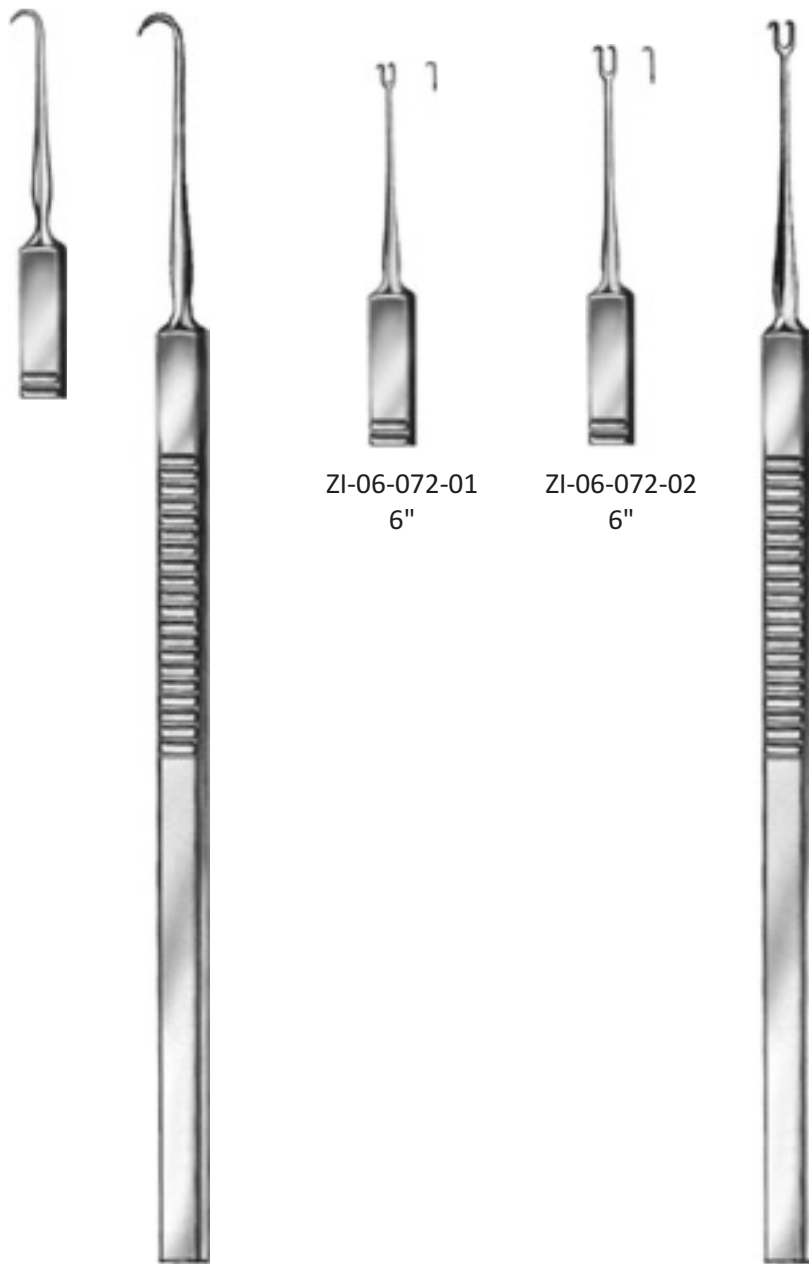

Skin Hook
O'Connor
ZI-06-070-16
6 1/4"

ZI-06-072-01
6"

ZI-06-072-02
6"

Skin Hook
Guthrie



Retractor



Hooklet



ZI-06-074-01
6 1/2"



ZI-06-074-02
6 1/2"



ZI-06-074-03
6 1/2"



ZI-06-074-04
6 1/2"



ZI-06-075-01
6 1/2"



ZI-06-075-02
6 1/2"



ZI-06-075-03
6 1/2"



ZI-06-075-04
6 1/2"



Retractor



Hooklet



ZI-06-078-02
6 1/4"
sharp

ZI-06-078-03
6 1/4"
sharp

ZI-06-078-04
6 1/4"
sharp



ZI-06-079-02
6 1/4"
blunt

ZI-06-079-03
6 1/4"
blunt

ZI-06-079-04
6 1/4"
blunt



ZI-06-086-04
6 1/2"
sharp

ZI-06-087-04
6 1/2"
blunt

Hooklet



Retractor



Vessel Hook
ZI-06-088-12
4 3/4"

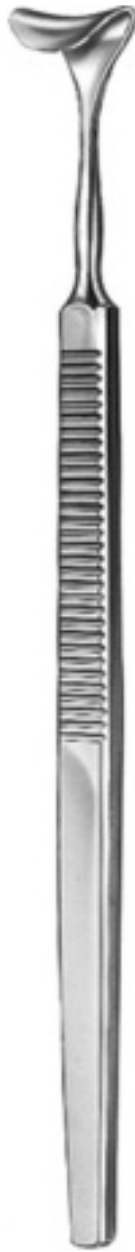

Saddle Hook
Desmarres



ZI-06-091-08
6 1/4"
8 mm



ZI-06-091-10
6 1/4"
10 mm



ZI-06-091-12
6 1/4"
12 mm



ZI-06-091-14
6 1/4"
14 mm



ZI-06-091-16
6 1/4"
16 mm



ZI-06-091-18
6 1/4"
18 mm



Retractor



Saddle Hook



ZI-06-093-12
6 1/4"
12 mm



ZI-06-093-14
6 1/4"
14 mm



ZI-06-093-16
6 1/4"
16 mm



ZI-06-093-18
6 1/4"
18 mm



Hooklet



Langenbeck-Mini
ZI-06-095-10
6 1/4"
10 x 6 mm



Langenbeck-Mini
ZI-06-095-17
6 1/4"
17 x 5 mm



Langenbeck-Mini
ZI-06-095-20
6 1/4"
20 x 6 mm



Langenbeck-Mini
ZI-06-095-22
6 1/4"
22 x 8 mm



Retractor

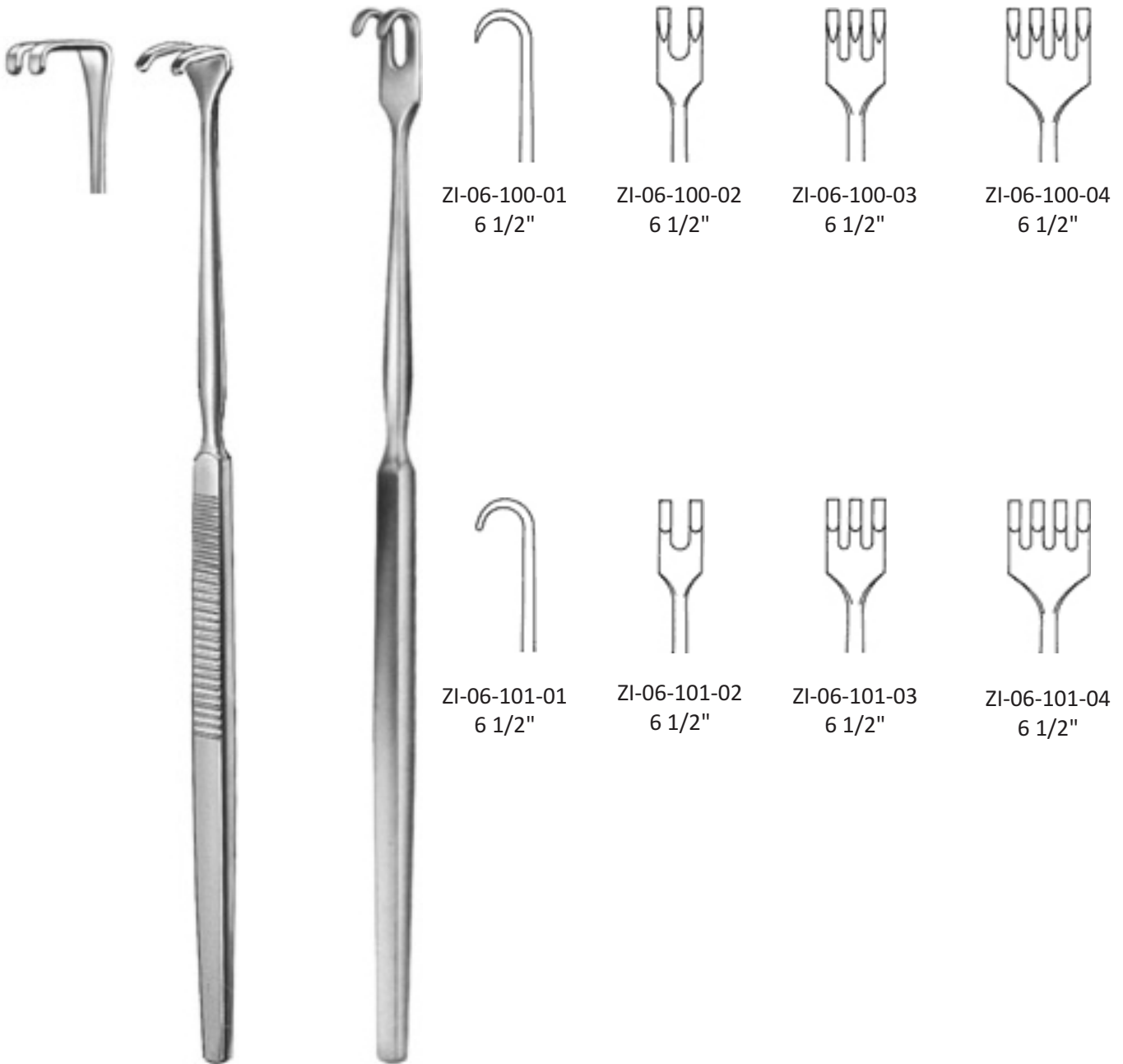

Hooklet
ZI-06-099-16
6 1/4"

Hooklet



Hooklet
Meyerding



ZI-06-151-01
7"
Fig. 118 x 7 mm
blunt



ZI-06-151-02
7"
Fig. 216 x 5 mm
toothed



ZI-06-151-03
7"
Fig. 37 x 4 mm
toothed



ZI-06-151-04
7"
Fig. 410 x 3 mm
blunt



ZI-06-151-05
7"
Fig. 57 x 4 mm
saddle shaped



ZI-06-151-06
7"
Fig. 610 x 4 mm
sharp



Hooklet



Senn-Green
ZI-06-161-01
6"
Fig. 1
20 x 6 mm



Senn-Green
ZI-06-161-02
6"
Fig. 2
10 x 6 mm



Hooklet
Ragnell-Davis
ZI-06-164-14
5 1/2" x 4 mm
15 x 5,5 mm

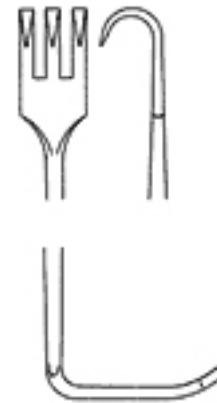

Senn-Miller
ZI-06-166-16
6 1/4"
teethblade
20 x 7 mm

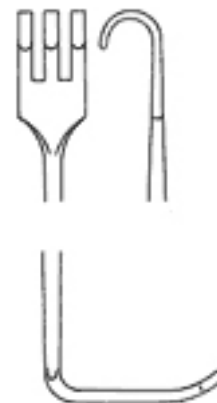

Senn-Miller
ZI-06-167-16
6 1/4"
teethblade
20 x 7 mm



Hooklet



ZARYAB
I N S T R U M E N T S

Products that saves life

Retractor

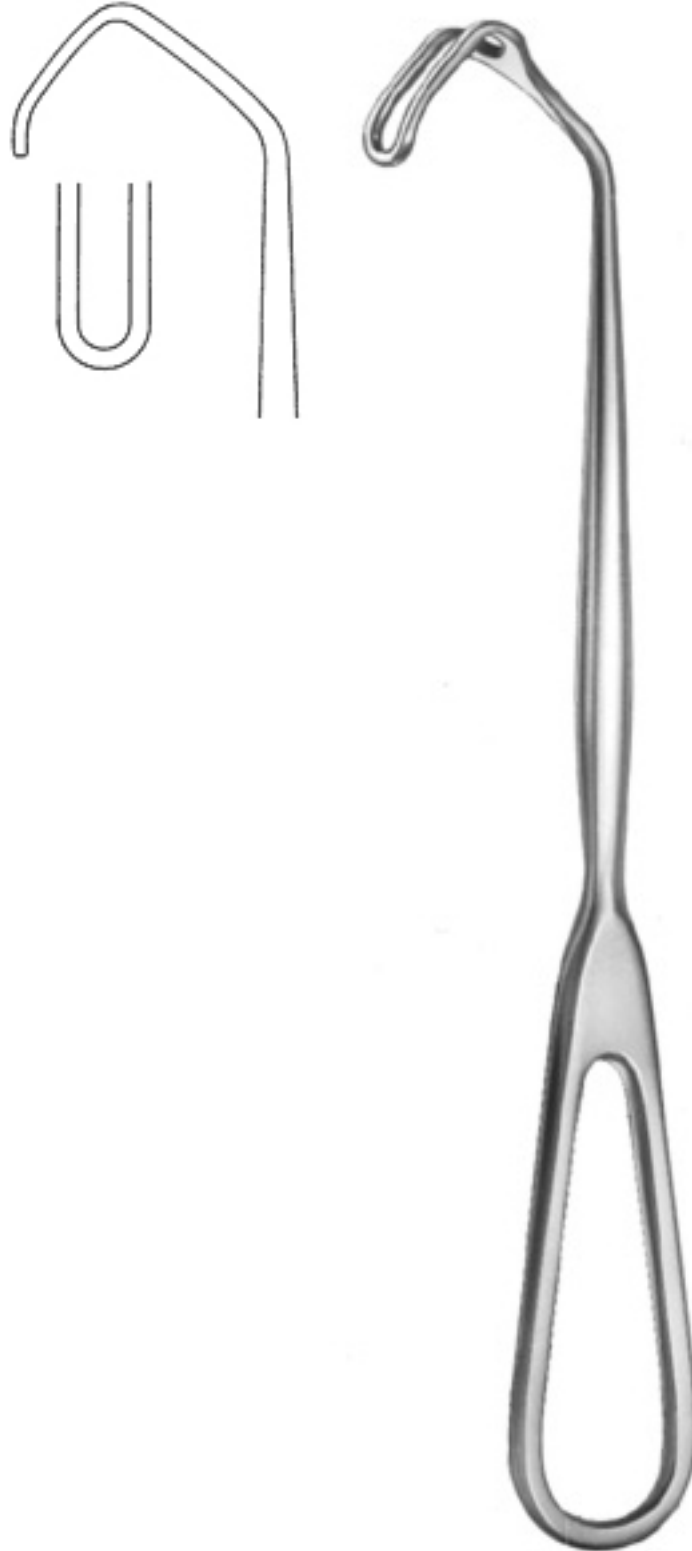

Retractor
Cushing
ZI-06-170-20
8"



Saddle Hook
Cushing



ZI-06-171-08
8"
8 mm wide



ZI-06-171-10
8"
10 mm wide



ZI-06-171-12
8"
12 mm wide



ZI-06-171-14
8"
14 mm wide



ZI-06-171-16
8"
16 mm wide



ZI-06-171-18
8"
18 mm wide

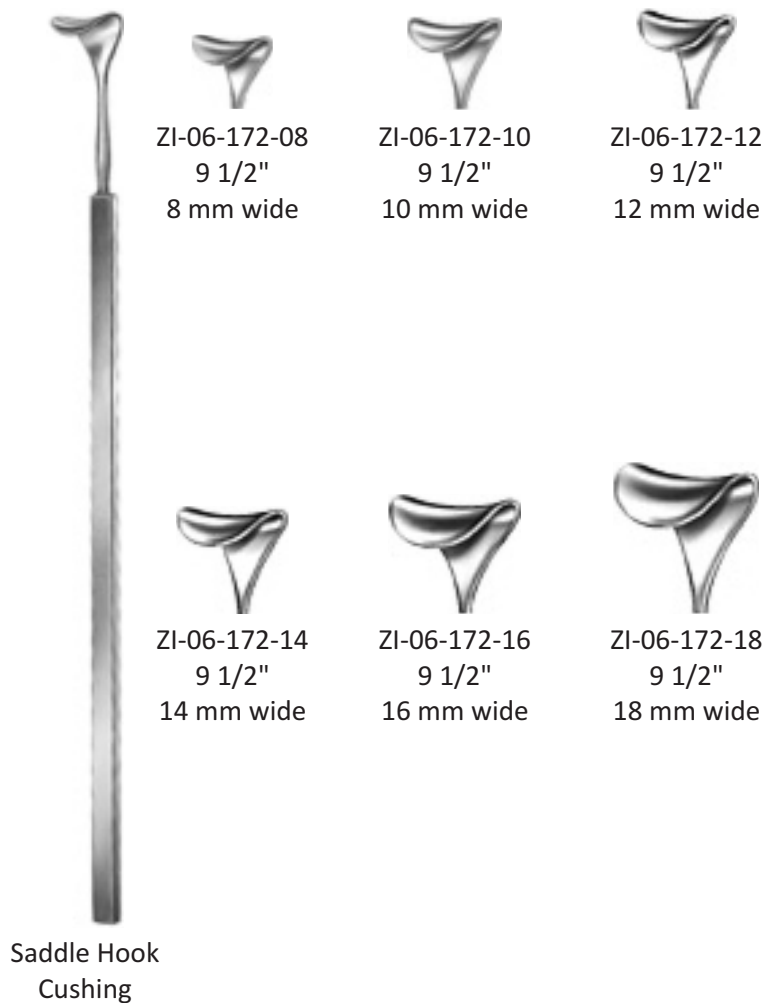



Saddle Hook
Gil-Vernet



ZI-06-174-08
9 1/2"
8 mm wide



ZI-06-174-11
9 1/2"
11 mm wide



ZI-06-174-15
9 1/2"
15 mm wide



ZI-06-174-17
9 1/2"
17 mm wide



ZI-06-174-20
9 1/2"
20 mm wide



ZI-06-174-23
9 1/2"
23 mm wide



Retractor



ZI-06-191-01
7 1/2"
Fig. 1
smooth blade end



ZI-06-191-02
7 1/2"
Fig. 2
toothed blade end



Hooklet
Strandell-Stillie



Vein Hook
Brom

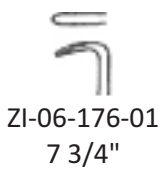

ZI-06-176-01
7 3/4"

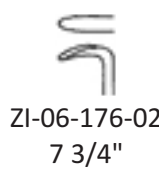

ZI-06-176-02
7 3/4"



Hooklet
Kaye-Millard
ZI-06-192-02
3"



Retractor
Klapp



ZI-06-195-01
7"
12 x 6 mm



ZI-06-195-02
7"
12 x 11 mm



ZI-06-195-03
7"
15 x 11 mm



ZARYAB
I N S T R U M E N T S

Products that saves life

Retractor



ZI-06-200-04
6 1/2"
sharp



ZI-06-201-04
6 1/2"
blunt

Hooklet



Retractor



Retractor
Volkmann



ZI-06-210-01
8 1/2"
sharp



ZI-06-210-02
8 1/2"
sharp



ZI-06-210-03
8 1/2"
sharp



ZI-06-210-04
8 1/2"
sharp

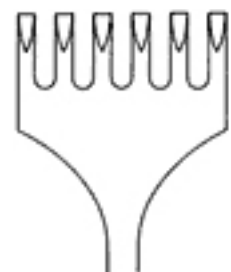

ZI-06-210-06
8 1/2"
sharp



ZI-06-211-01
8 1/2"
blunt



ZI-06-211-02
8 1/2"
blunt



ZI-06-211-03
8 1/2"
blunt



ZI-06-211-04
8 1/2"
blunt

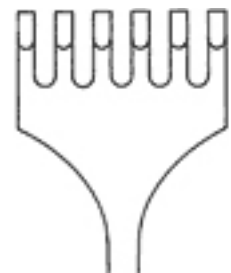

ZI-06-211-06
8 1/2"
blunt



Retractor



Retractor
Volkmann



ZI-06-220-01
8 3/4"
sharp



ZI-06-220-02
8 3/4"
sharp



ZI-06-220-03
8 3/4"
sharp



ZI-06-220-04
8 3/4"
sharp

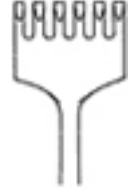

ZI-06-220-06
8 3/4"
sharp



ZI-06-221-01
8 3/4"
blunt



ZI-06-221-02
8 3/4"
blunt



ZI-06-221-03
8 3/4"
blunt



ZI-06-221-04
8 3/4"
blunt

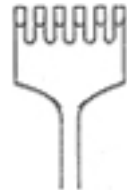

ZI-06-221-06
8 3/4"
blunt



ZI-06-222-01
8 3/4"
semi-sharp



ZI-06-222-02
8 3/4"
semi-sharp



ZI-06-222-03
8 3/4"
semi-sharp



ZI-06-222-04
8 3/4"
semi-sharp



ZI-06-222-06
8 3/4"
semi-sharp



Retractor



Retractor
Volkman



ZI-06-230-01
8 1/2"
sharp



ZI-06-231-01
8 1/2"
blunt



Retractor
Volkman
ZI-06-232-01
8 1/2"
sharp



Retractor



Retractor
Kocher

ZI-06-240-01 8 3/4" sharp	ZI-06-240-02 8 3/4" sharp	ZI-06-240-03 8 3/4" sharp	ZI-06-240-04 8 3/4" sharp	ZI-06-240-06 8 3/4" sharp	ZI-06-240-08 8 3/4" sharp
ZI-06-240-01 8 3/4" blunt	ZI-06-240-02 8 3/4" blunt	ZI-06-240-03 8 3/4" blunt	ZI-06-240-04 8 3/4" blunt	ZI-06-240-06 8 3/4" blunt	ZI-06-240-08 8 3/4" blunt
ZI-06-240-01 8 3/4" semi-sharp	ZI-06-240-02 8 3/4" semi-sharp	ZI-06-240-03 8 3/4" semi-sharp	ZI-06-240-04 8 3/4" semi-sharp	ZI-06-240-06 8 3/4" semi-sharp	ZI-06-240-08 8 3/4" semi-sharp



Retractor



Retractor
Martin

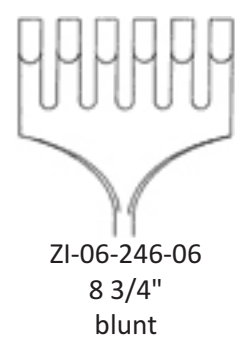
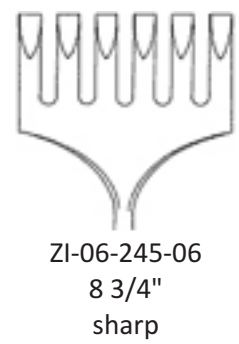



ZARYAB
I N S T R U M E N T S

Products that saves life

Retractor



Retractor
Ollier



ZI-06-251-03
9"
36 x 30 mm

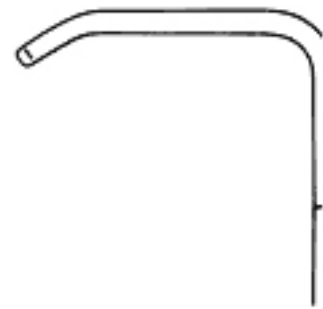

ZI-06-253-04
9"
36 x 60 mm



ZARYAB
I N S T R U M E N T S

Products that saves life

Retractor

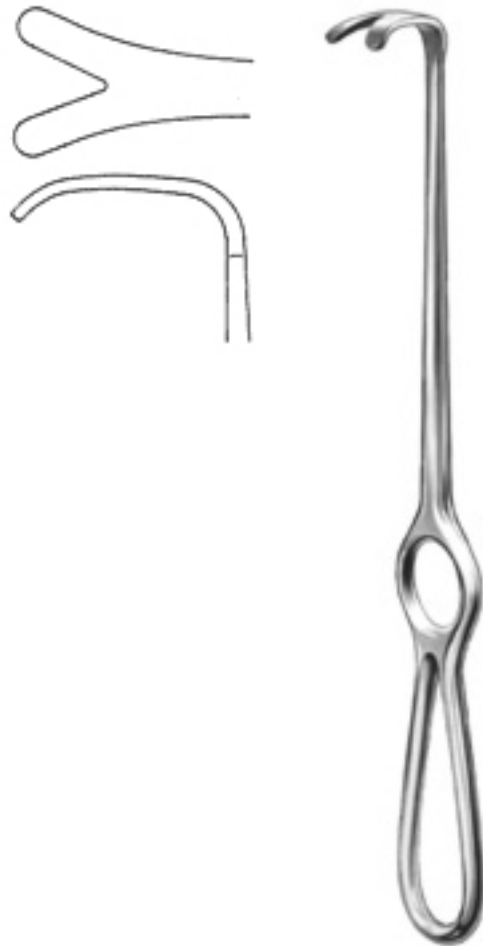

Retractor
Wassmund
ZI-06-261-02
8"33 x 21 mm



Retractor



Retractor
Israel



ZI-06-281-04
10"
40 x 40 mm



ZI-06-283-05
10"
45 x 50 mm



ZI-06-287-06
10"
50 x 60 mm



ZI-06-289-07
10"
70 x 70 mm



ZARYAB
I N S T R U M E N T S

Products that saves life

Retractor



Retractor
Körte

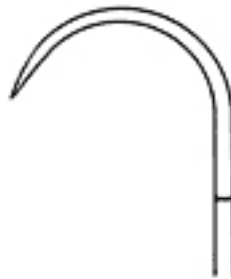

ZI-06-266-08
9 3/4"
40 x 30 mm
sharp

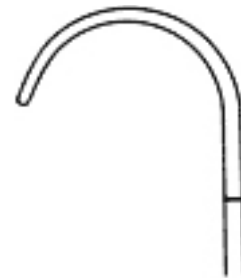

ZI-06-267-08
9 3/4"
40 x 30 mm
blunt



Retractor
Langenbeck



ZI-06-291-01
8 3/4"
30 x 11 mm

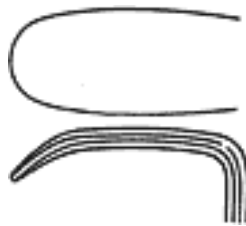

ZI-06-291-02
8 3/4"
30 x 14 mm

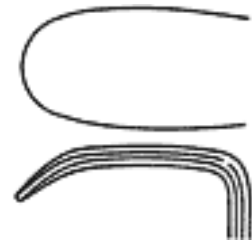

ZI-06-291-03
8 3/4"
30 x 16 mm



ZI-06-291-04
8 3/4"
40 x 11 mm



ZI-06-291-05
8 3/4"
50 x 11 mm



Retractor
Langenbeck



ZI-06-293-01
8 3/4"
30 x 11 mm



ZI-06-293-02
8 3/4"
30 x 14 mm



ZI-06-293-03
8 3/4"
30 x 16 mm



ZI-06-293-04
8 3/4"
40 x 11 mm



ZI-06-293-05
8 3/4"
50 x 11 mm



ZARYAB
I N S T R U M E N T S

Products that saves life

Retractor

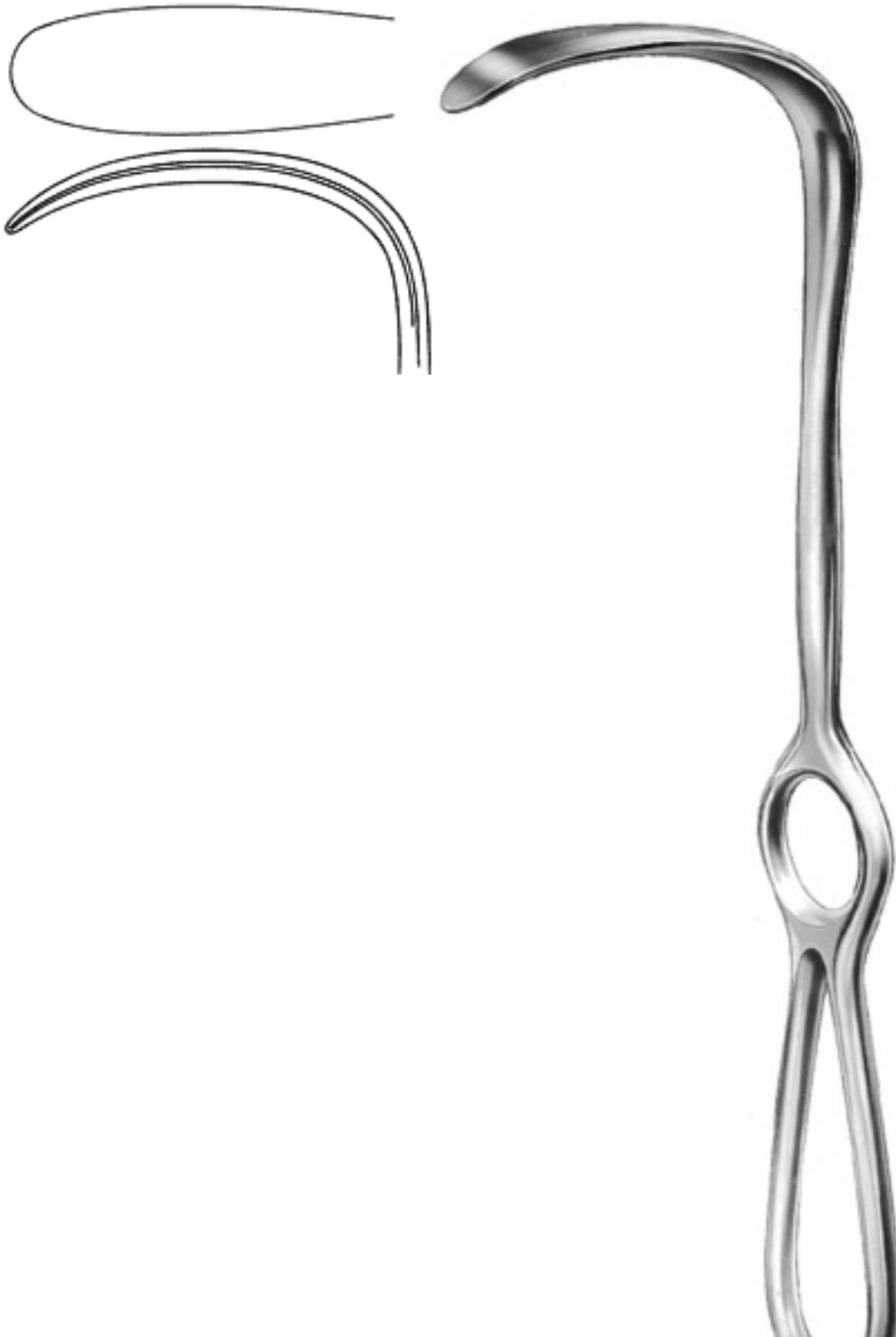

Retractor
Langenbeck
ZI-06-295-21
8 1/4"



ZARYAB
I N S T R U M E N T S

Products that saves life

Retractor

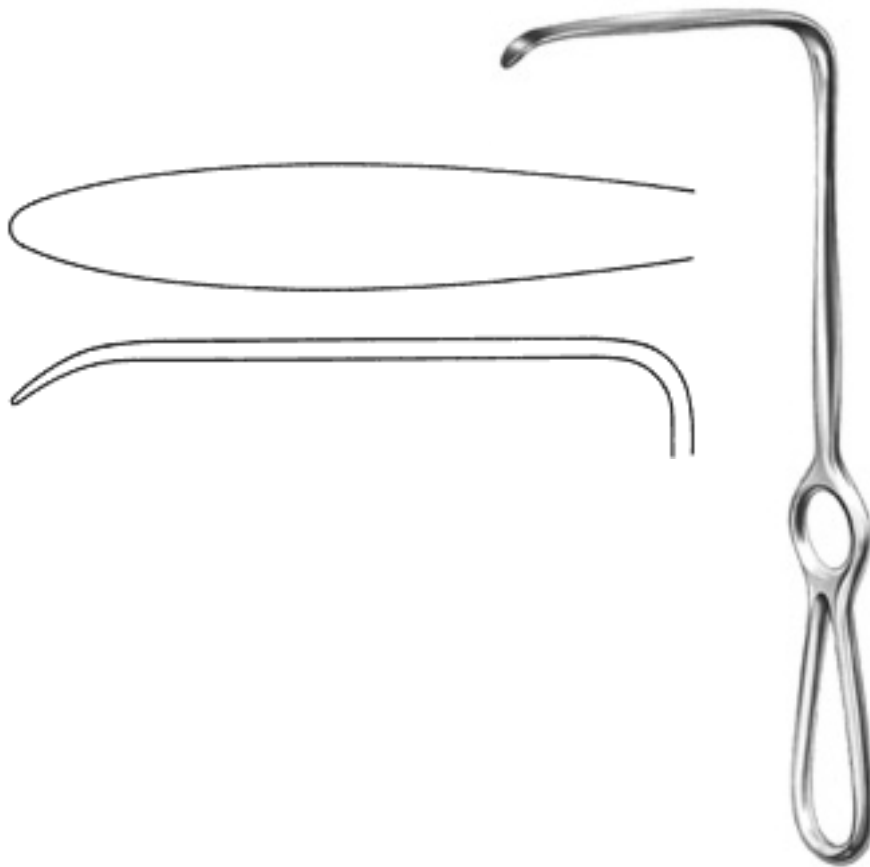

Retractor
Langenbeck
ZI-06-297-21
8 3/4"
85 x 15 mm



ZARYAB
I N S T R U M E N T S

Products that saves life

Retractor

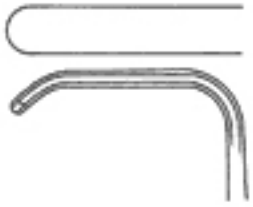

Retractor
Lahey
ZI-06-307-19
7 3/4"
31 x 6 mm



Retractor
Little
ZI-06-313-20
8"
13 x 15 mm



Retractor

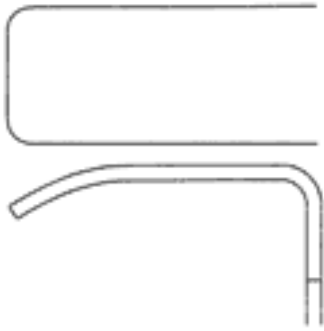

ZI-06-315-18
9"
43 x 18 mm



ZI-06-315-20
9"
53 x 20 mm



ZI-06-315-25
9"
63 x 25 mm



Retractor
Kocher



ZI-06-315-30
9"
77 x 30 mm



ZI-06-315-40
9"
78 x 40 mm



Retractor



ZI-06-317-01
8 1/2"
25 x 6 mm



ZI-06-317-02
8 1/2"
35 x 8 mm

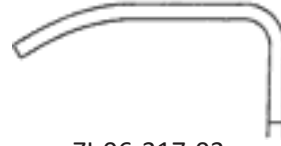

ZI-06-317-03
8 1/2"
35 x 11 mm



ZI-06-317-04
8 1/2"
35 x 15 mm



ZI-06-317-05
8 1/2"
40 x 11 mm



ZI-06-317-06
8 1/2"
55 x 11 mm



ZI-06-317-07
8 1/2"
70 x 14 mm

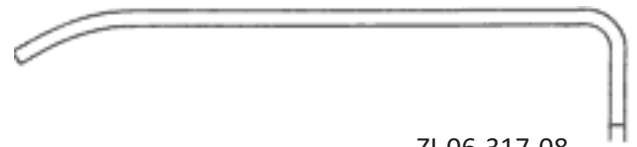

ZI-06-317-08
8 1/2"
80 x 12 mm



ZI-06-317-09
8 1/2"
80 x 16 mm



Retractor
Kocher-Langenbeck



ZARYAB
I N S T R U M E N T S

Products that saves life

Retractor



Retractor
Kocher-Langenbeck



ZI-06-319-01
8 1/2"
25 x 10 mm



ZI-06-317-09
8 1/2"
40 x 13 mm



ZI-06-319-03
8 1/2"
60 x 13 mm



ZI-06-319-04
8 1/2"
40 x 18 mm



ZI-06-319-05
8 1/2"
60 x 18 mm



ZI-06-319-06
8 1/2"
85 x 18 mm



ZI-06-319-07
8 1/2"
60 x 25 mm



ZI-06-319-08
8 1/2"
85 x 25 mm



Retractor

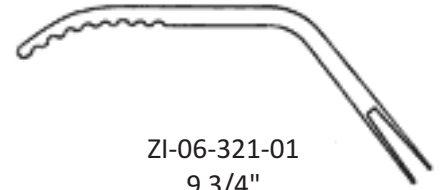

ZI-06-321-01
9 3/4"
35 x 8 mm

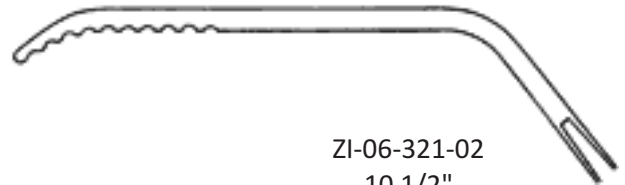

ZI-06-321-02
10 1/2"
60 x 12 mm

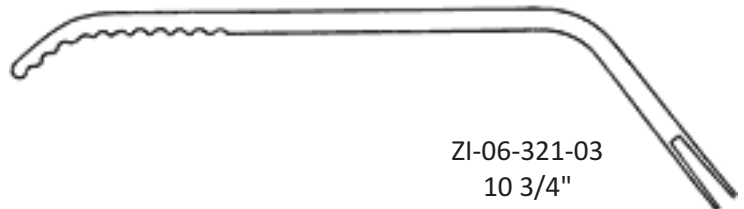

ZI-06-321-03
10 3/4"
75 x 12 mm



ZI-06-321-04
11 1/4"
85 x 20 mm



ZI-06-321-05
12"
100 x 25 mm



Retractor
Zenker



Retractor



Retractor
Kocher



ZI-06-325-01
8 1/2"
22 x 12 mm



ZI-06-325-02
8 1/2"
24 x 14 mm



Retractor
Kocher



ZI-06-351-01
8 3/4"
42 x 10 mm



ZI-06-351-02
9"
42 x 15 mm



ZI-06-351-01
9"
43 x 20 mm



Retractor
Middeldorpf



ZI-06-361-01
8 1/2"
18 x 17 mm



ZI-06-361-02
9"
25 x 22 mm



ZI-06-361-03
9 3/4"
30 x 31 mm



ZARYAB
INSTRUMENTS

Products that saves life

Retractor



Retractor
Richardson-Eastman
ZI-06-381-01
10 1/4"

Fig. 128 x 20 mm + 36 x 28 mm



Retractor
Richardson-Eastman
ZI-06-381-02
10 1/2"

Fig. 249 x 38 mm + 63 x 49 mm



Retractor



Retractor
Richardson



ZI-06-391-01
9 1/4"
30 x 21 mm



ZI-06-391-02
9 1/2"
37 x 29 mm



ZI-06-391-03
9 1/2"
45 x 40 mm



ZARYAB
I N S T R U M E N T S

Products that saves life

Retractor



Retractor
Richardson
ZI-06-395-24
9 1/2"
53 x 22 mm



Retractor
Kelly
ZI-06-397-26
10 1/4"
70 x 50 mm



Retractor
Doyen-Stillie

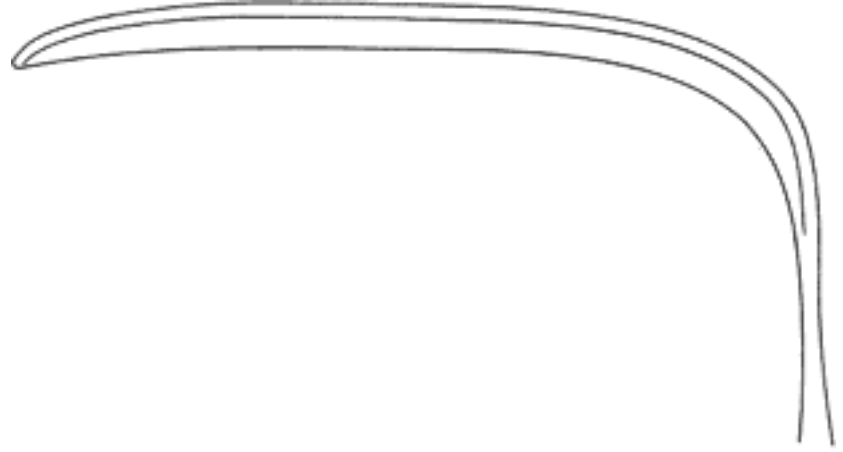

ZI-06-401-01
10 1/4"
97 x 29 mm

ZI-06-401-02
10 1/4"
101 x 31 mm

ZI-06-401-03
10 1/4"
127 x 52 mm



Retractor



Retractor
Hösel

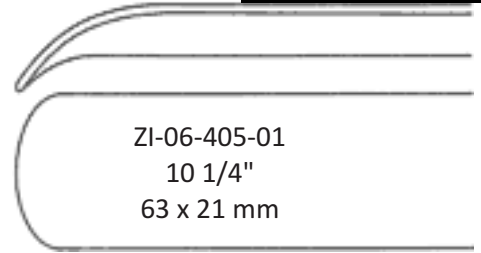

ZI-06-405-01
10 1/4"
63 x 21 mm

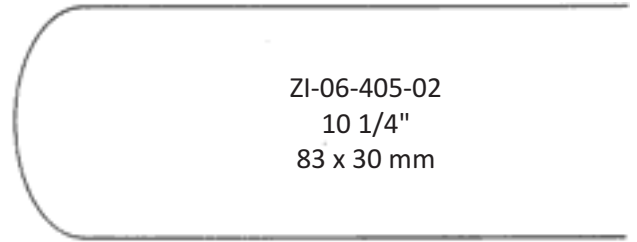

ZI-06-405-02
10 1/4"
83 x 30 mm

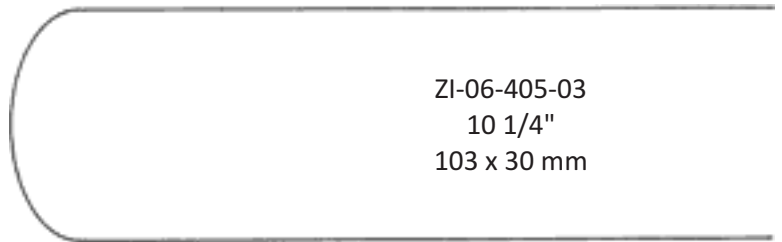

ZI-06-405-03
10 1/4"
103 x 30 mm

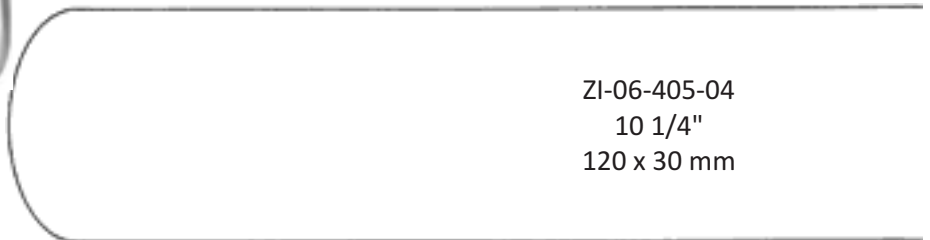

ZI-06-405-04
10 1/4"
120 x 30 mm

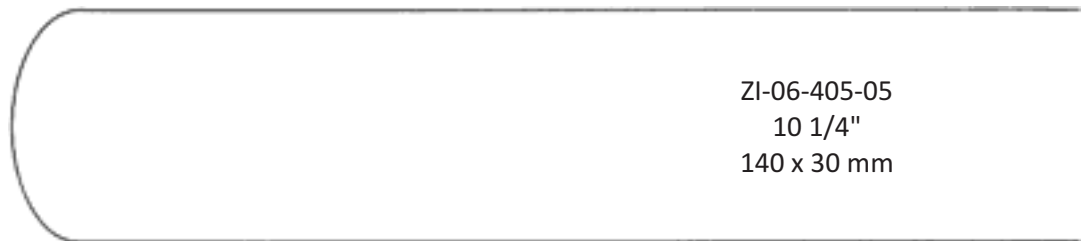

ZI-06-405-05
10 1/4"
140 x 30 mm

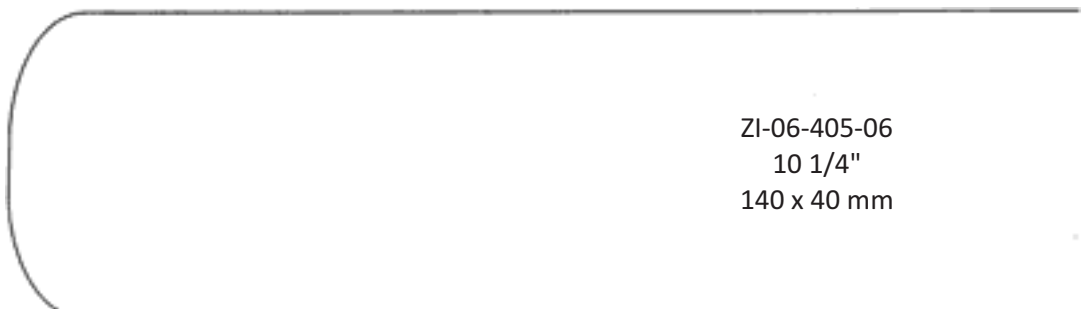

ZI-06-405-06
10 1/4"
140 x 40 mm



Retractor



Retractor
Middeldorpf



ZI-06-441-01
10 3/4"
48 x 45 mm



ZI-06-441-02
10 3/4"
52 x 50 mm



ZI-06-441-03
11"
60 x 70 mm



Retractor



ZI-06-452-00
9 1/4"
37 x 31 mm



ZI-06-452-01
9 1/2"
38 x 40 mm



ZI-06-452-02
9 3/4"
43 x 51 mm



ZI-06-452-03
9 1/4"
49 x 61 mm



ZI-06-452-04
10"
48 x 75 mm

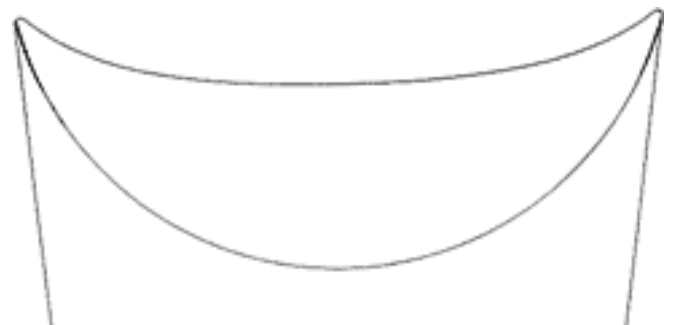

ZI-06-452-05
10 1/2"
65 x 85mm



Retractor
Fritsch



ZARYAB
I N S T R U M E N T S

Products that saves life

Retractor



Retractor
Doyen
ZI-06-461-25
9 1/2"
48 x 88 mm



Retractor
Kocher
ZI-06-469-22
9 1/2"
73 x 25 mm



ZARYAB
INSTRUMENTS

Products that saves life

Retractor



Retractor
Kocher
ZI-06-471-01
9 3/4"
80 x 45 mm



Retractor
Kocher
ZI-06-471-01
9 3/4"
80 x 55 mm



Retractor
Kocher
ZI-06-471-01
9 3/4"
80 x 65 mm



ZARYAB
I N S T R U M E N T S

Products that saves life

Retractor



Retractor
Martin
ZI-06-501-25
10 1/4"
110 x 27 mm



ZARYAB
I N S T R U M E N T S

Products that saves life

Retractor

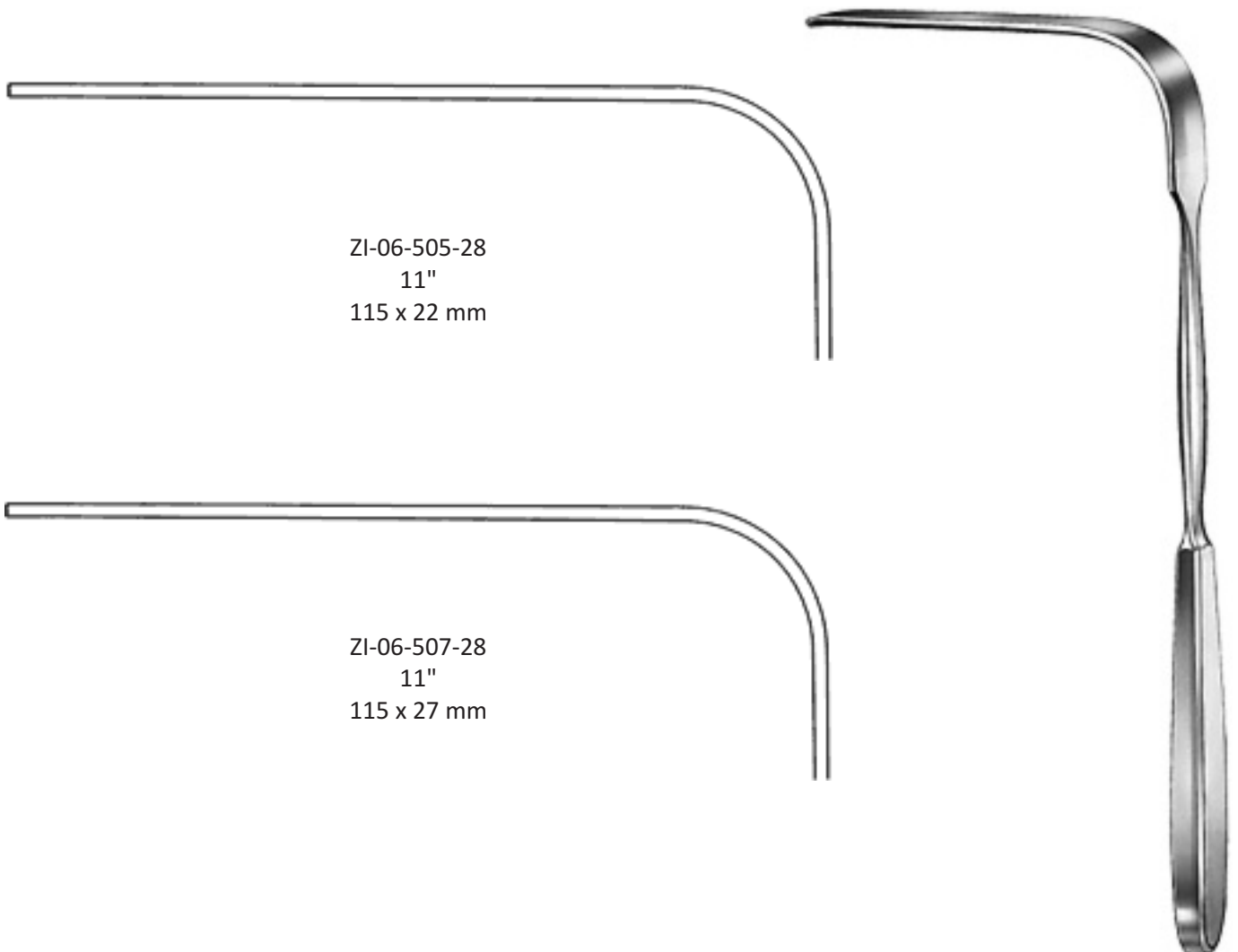

ZI-06-505-28
11"
115 x 22 mm

ZI-06-507-28
11"
115 x 27 mm

Retractor
Simon



Retractor

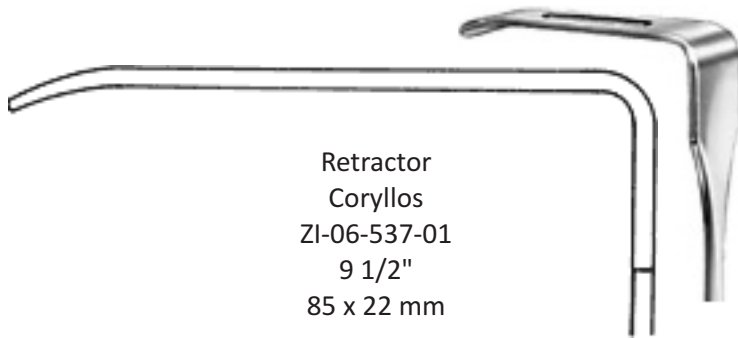

Retractor
Coryllos
ZI-06-537-01
9 1/2"
85 x 22 mm

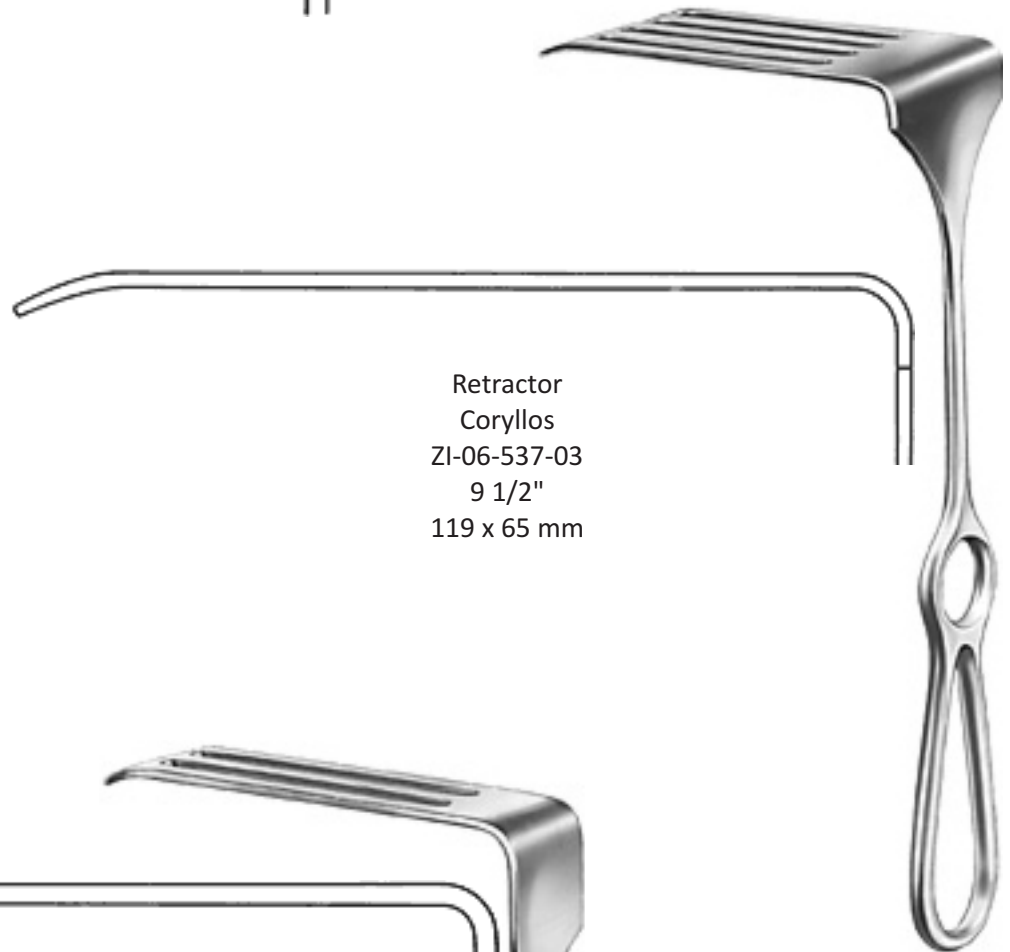

Retractor
Coryllos
ZI-06-537-03
9 1/2"
119 x 65 mm

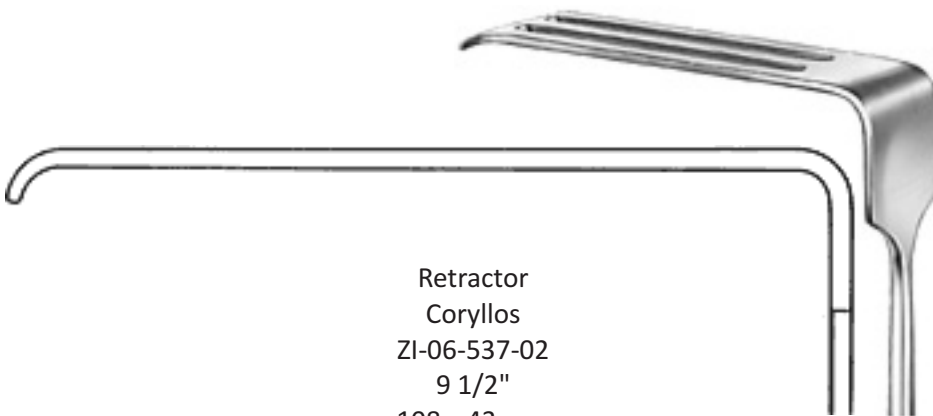

Retractor
Coryllos
ZI-06-537-02
9 1/2"
108 x 43 mm



ZARYAB
I N S T R U M E N T S

Products that saves life

Retractor



Scapula Retractor

Davidson

ZI-06-545-01

7 1/2"

80 x 54 mm

Scapula Retractor

Davidson

ZI-06-545-02

7 1/4"

80 x 95 mm



ZARYAB
I N S T R U M E N T S

Products that saves life

Retractor

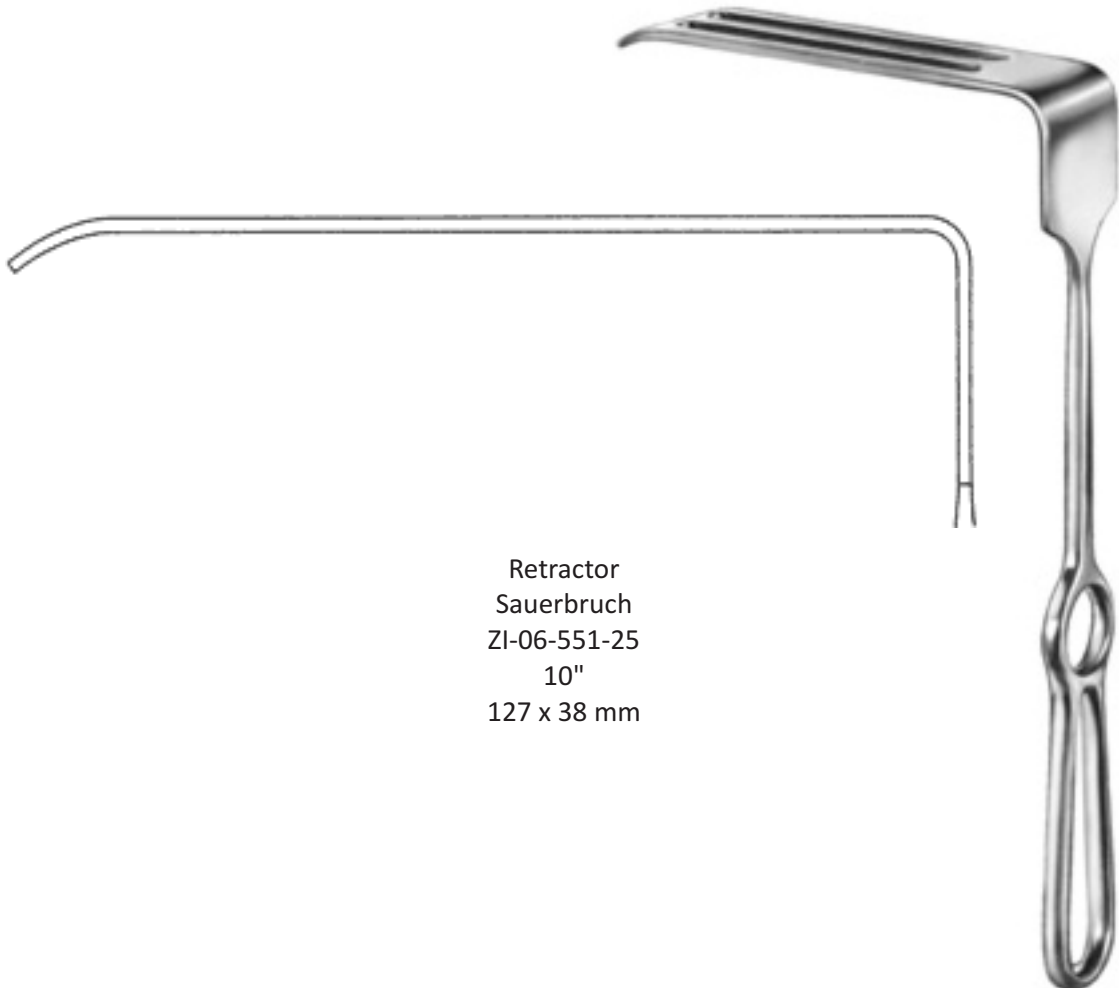

Retractor
Sauerbruch
ZI-06-551-25
10"
127 x 38 mm



Retractor



Retractor
Brunner

	ZI-06-558-08 10" 84 x 20 mm
	ZI-06-558-10 10" 104 x 25 mm
	ZI-06-558-12 10" 124 x 30 mm
	ZI-06-558-13 10" 130 x 30 mm
	ZI-06-558-14 10" 144 x 30 mm
	ZI-06-558-16 10" 160 x 30 mm
	ZI-06-558-18 10" 164 x 30 mm



Retractor



Retractor
Brunner

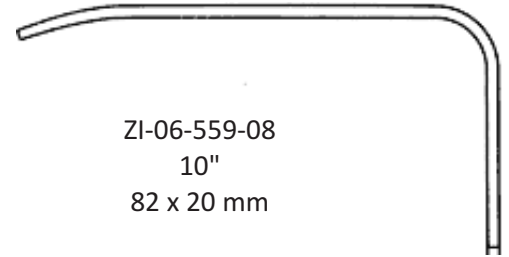

ZI-06-559-08
10"
82 x 20 mm

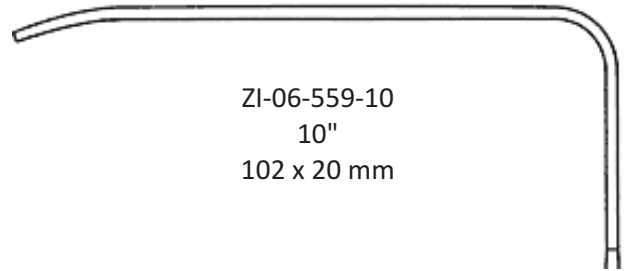

ZI-06-559-10
10"
102 x 20 mm

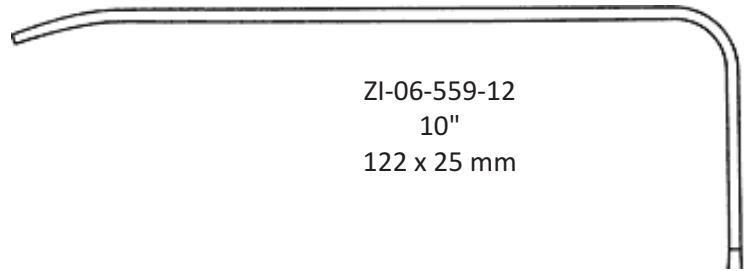

ZI-06-559-12
10"
122 x 25 mm

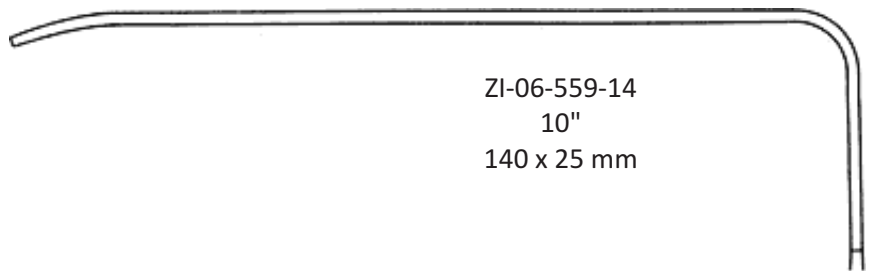

ZI-06-559-14
10"
140 x 25 mm

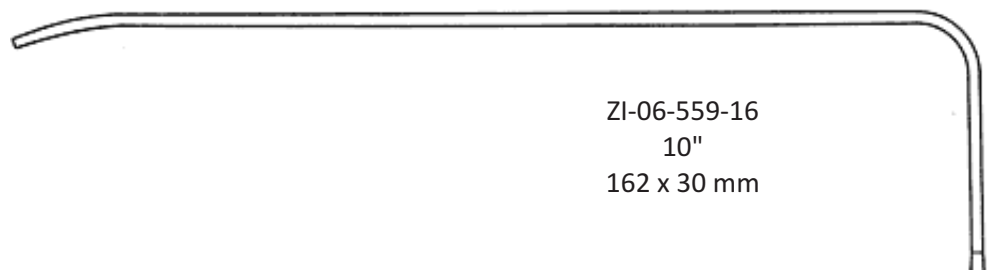

ZI-06-559-16
10"
162 x 30 mm

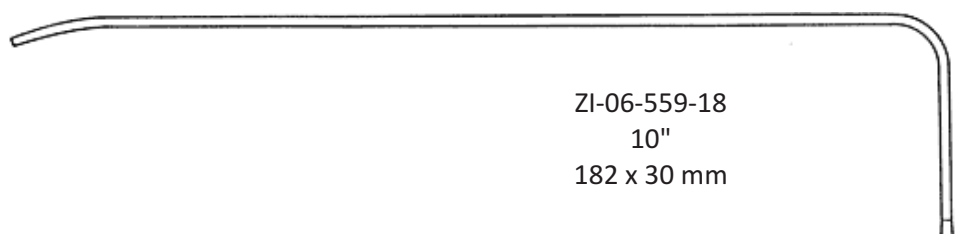

ZI-06-559-18
10"
182 x 30 mm



ZARYAB
I N S T R U M E N T S

Products that saves life

Retractor



Retractor
Sauerbruch



ZI-06-561-01
8 3/4"
50 x 15 mm

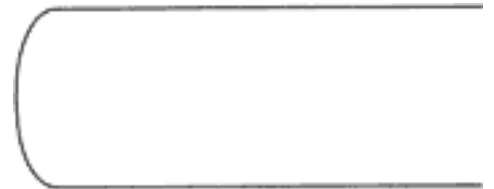

ZI-06-561-02
8 3/4"
63 x 23 mm

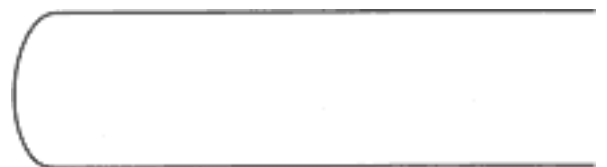

ZI-06-561-03
8 3/4"
80 x 20 mm



ZARYAB
I N S T R U M E N T S

Products that saves life

Retractor



Aorta Retractor
Crawford

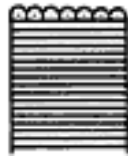

ZI-06-562-01
7 ½"
15 x 15 mm

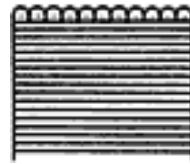

ZI-06-562-02
7 ½"
15 x 23 mm



Retractor



Aorta Retractor
Ross



ZI-06-563-01
10"
Fig. 1



ZI-06-563-02
10"
Fig. 2



ZI-06-563-03
10"
Fig.3



ZI-06-563-04
10"
Fig. 4



ZI-06-563-05
10"
Fig. 5



ZI-06-563-06
10"
Fig. 6



ZARYAB
I N S T R U M E N T S

Products that saves life

Retractor

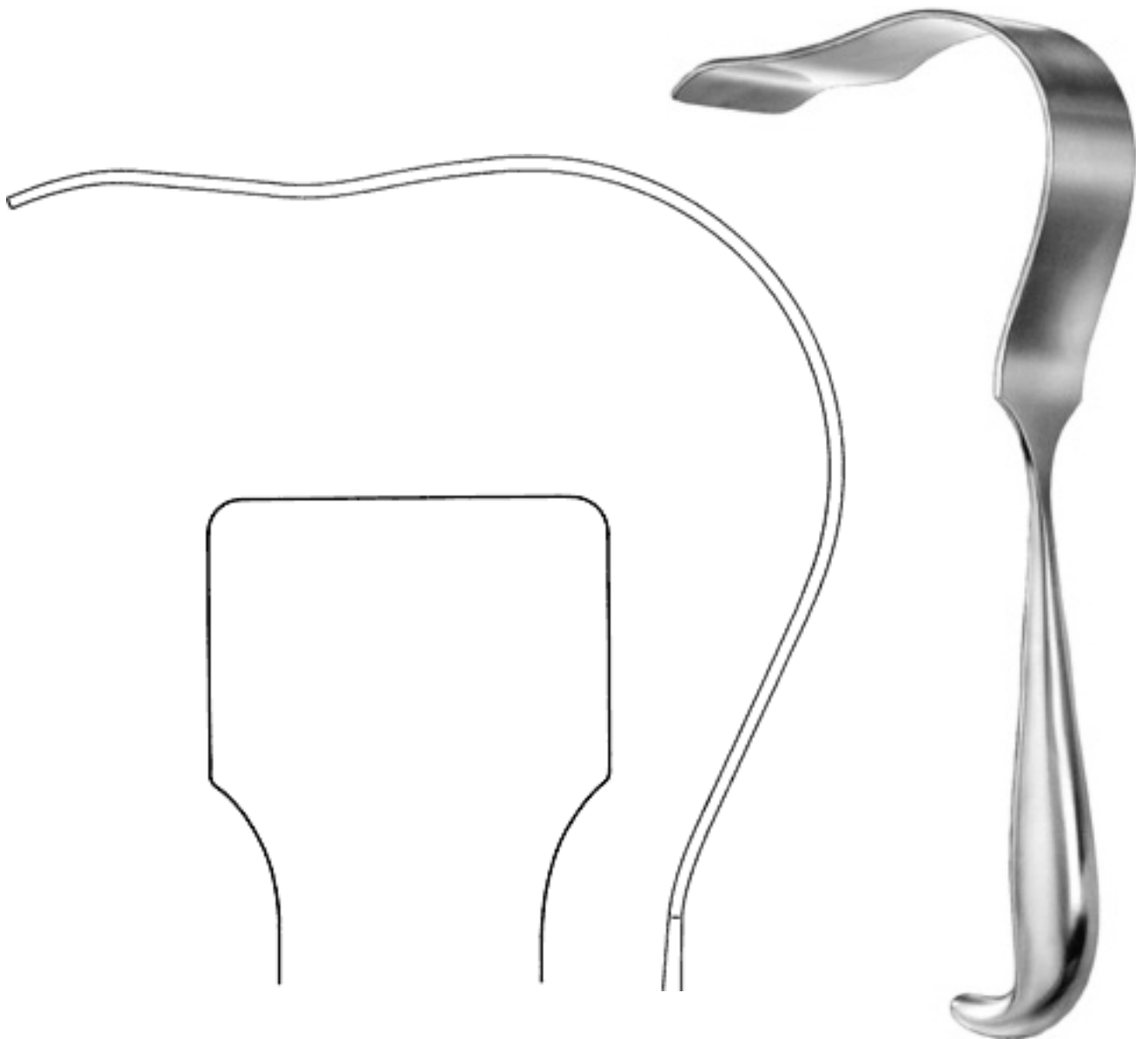

Retractor
Polloson
ZI-06-577-27
11 1/2"



ZARYAB
I N S T R U M E N T S

Products that saves life

Retractor

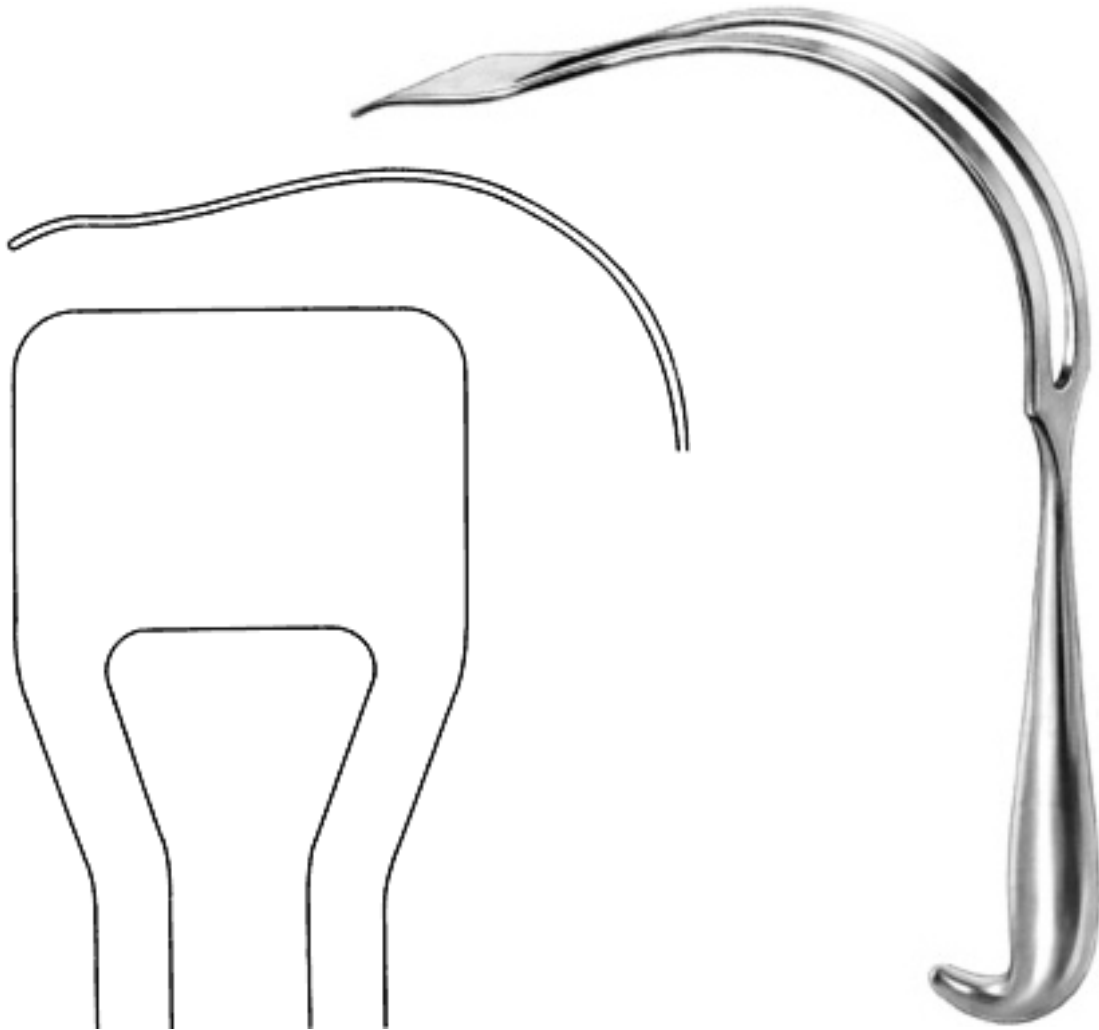

Retractor
Polloson
ZI-06-579-27
10"



ZARYAB
I N S T R U M E N T S

Products that saves life

Retractor

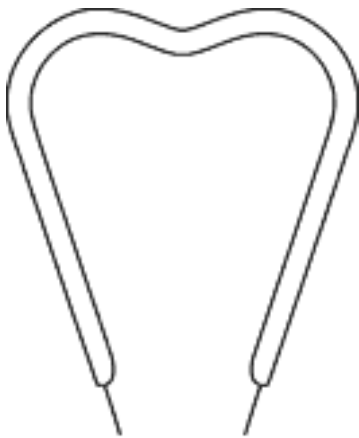

ZI-06-581-01
12 1/2"
137 x 44 mm

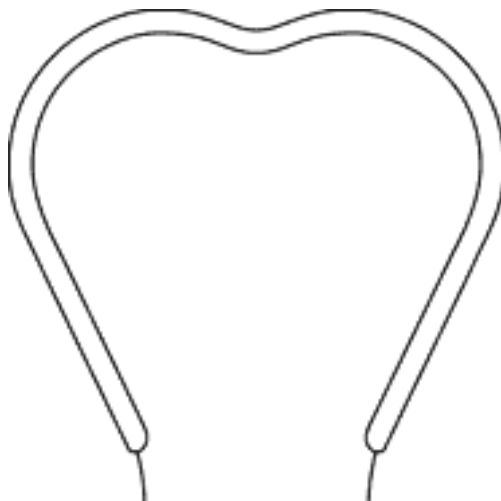

ZI-06-581-02
13"
137 x 65 mm



Retractor
Harrington



ZARYAB
INSTRUMENTS

Products that saves life

Retractor



Retractor
Deaver
ZI-06-591-01
7"
19 mm



Retractor
Deaver
ZI-06-591-02
8 1/2"
22 mm



Retractor
Deaver
ZI-06-591-03
9 3/4"
25 mm



ZARYAB
I N S T R U M E N T S

Products that saves life

Retractor



Retractor
Deaver
ZI-06-591-04
12 1/4"
25 mm



Retractor
Deaver
ZI-06-591-05
13"
25 mm



Retractor
Deaver
ZI-06-591-06
14 1/4"
25 mm



ZARYAB
INSTRUMENTS

Products that saves life

Retractor



Retractor
Deaver
ZI-06-591-07
11 3/4"
38 mm



Retractor
Deaver
ZI-06-591-08
12 1/4"
50 mm



Retractor
Deaver
ZI-06-591-09
12 1/2"
75 mm



Retractor

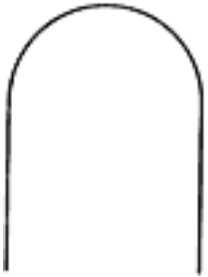

HIM-06-592-04
12 ½"
25 mm

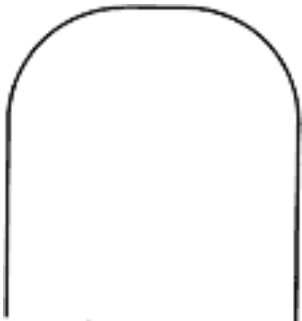

ZI-06-592-07
12 ½"
38 mm

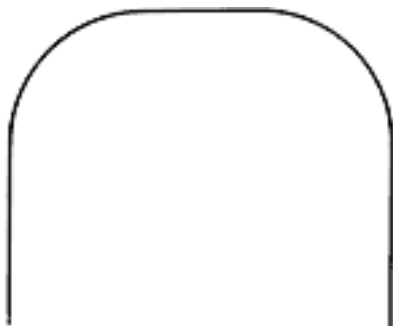

ZI-06-592-08
12 ½"
50 mm

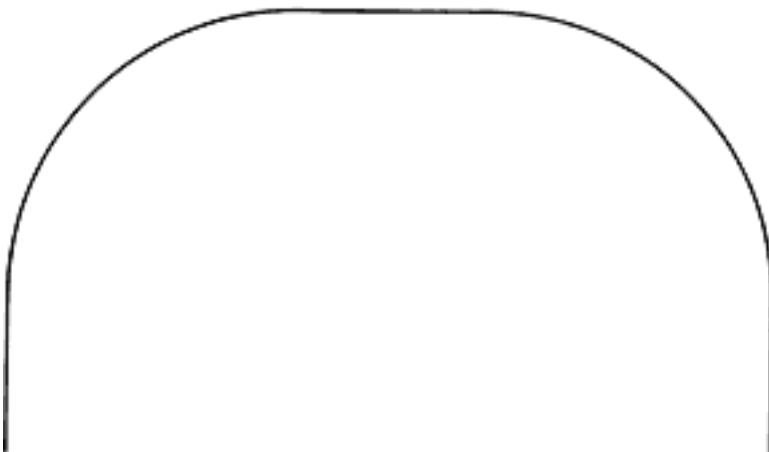

ZI-06-592-10
12 ½"
100 mm



Retractor
Deaver



Retractor



Atrium Retractor
Cooley
ZI-06-593-01
9 3/4"
48 x 48 mm
right



Atrium Retractor
Cooley
ZI-06-593-02
9 3/4"
48 x 48 mm
right, serrated



Atrium Retractor
Cooley
ZI-06-593-03
10 1/2"
30 x 48 mm
left



Retractor

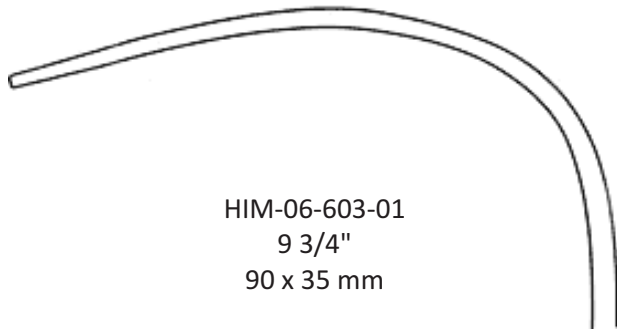

HIM-06-603-01
9 3/4"
90 x 35 mm

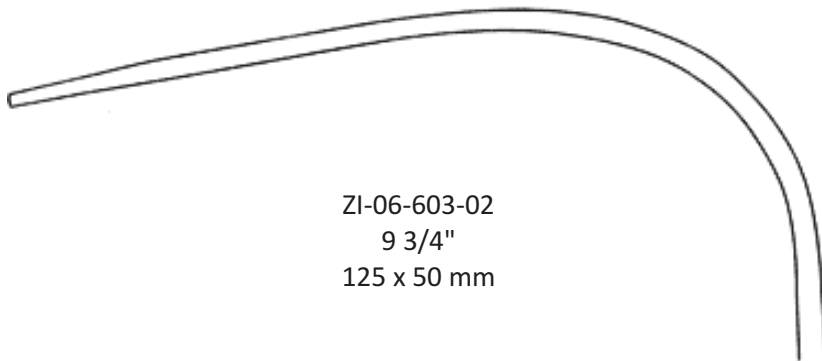

ZI-06-603-02
9 3/4"
125 x 50 mm

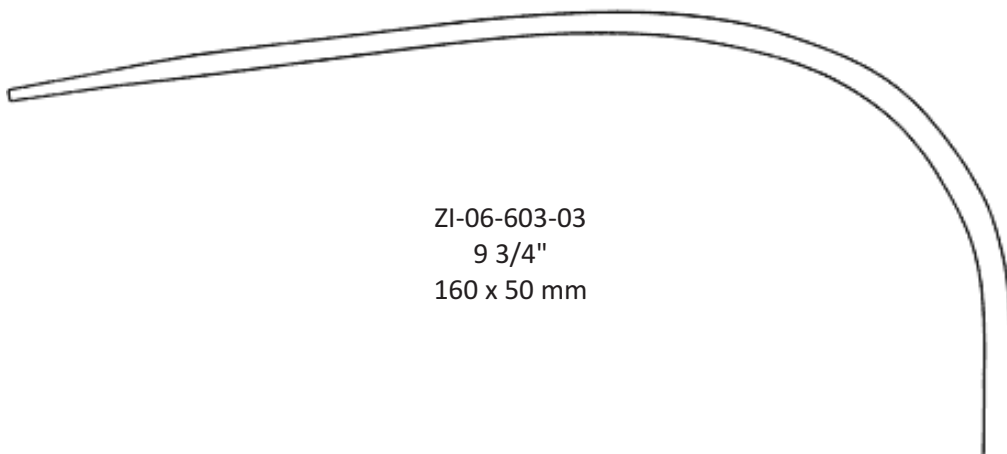

ZI-06-603-03
9 3/4"
160 x 50 mm



Liver Retractor
Mikulicz



ZARYAB
I N S T R U M E N T S

Products that saves life

Retractor



Retractor
Mikulicz
ZI-06-607-26
90 x 55 mm

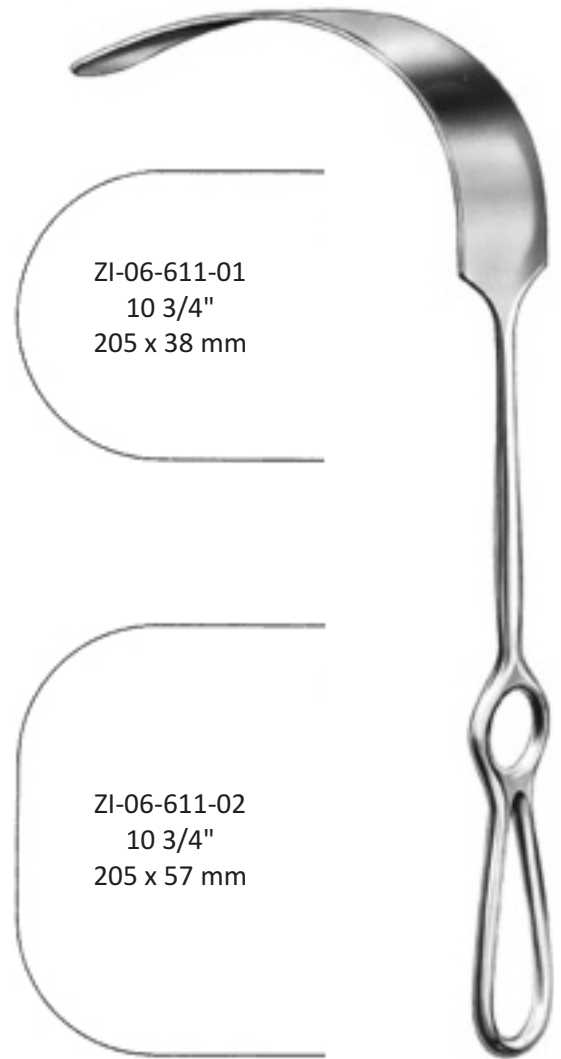

Retractor
Kelly



ZARYAB
I N S T R U M E N T S

Products that saves life

Retractor



Pelvis Retractor
St. Marks

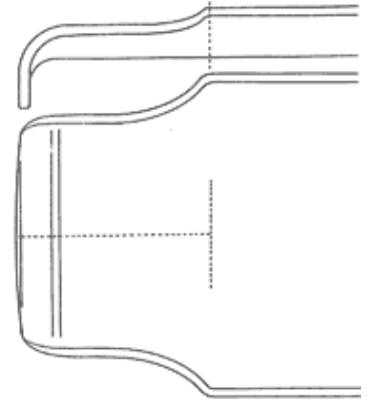

ZI-06-615-01
11 1/2"
142 x 60 mm 35 x 45 mm

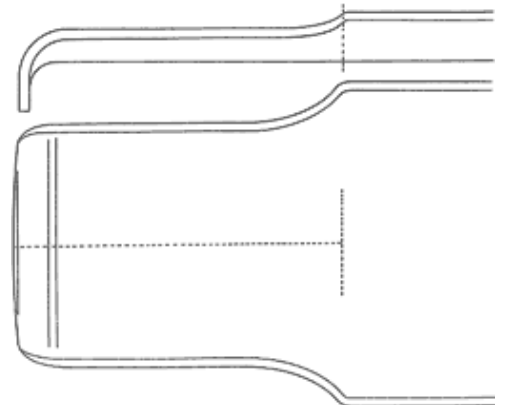

ZI-06-615-02
11 1/2"
193 x 60 mm 60 x 45 mm

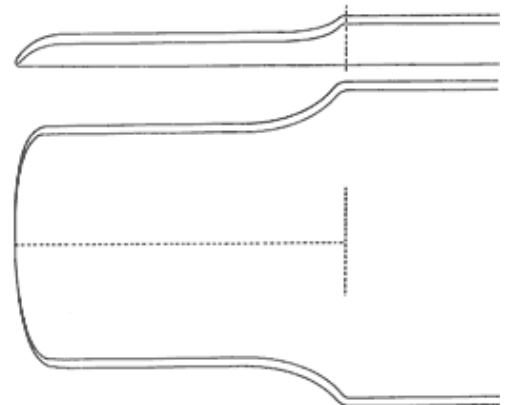

ZI-06-615-03
13"
195 x 60 mm 60 x 45 mm



ZARYAB
I N S T R U M E N T S

Products that saves life

Retractor



Abdominal Spatula
Kümmel
ZI-06-621-28
12 1/4"
100 x 45 mm



ZARYAB
INSTRUMENTS

Products that saves life

Retractor



ZI-06-623-20
11"
20 mm



ZI-06-623-30
11"
30 mm



ZI-06-623-40
11"
40 mm

Abdominal Spatula
Kader



Retractor
Roux



ZI-06-655-00
6 3/4"
Fig. 1-3



ZI-06-655-01
5 1/2"
Fig. 1

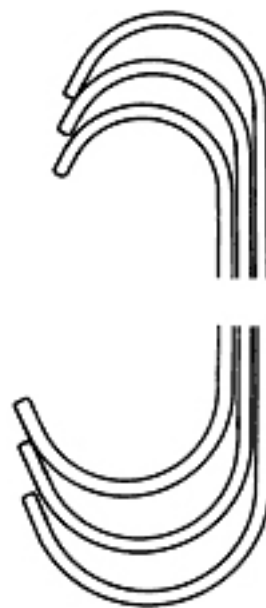

ZI-06-655-02
6"
Fig. 2

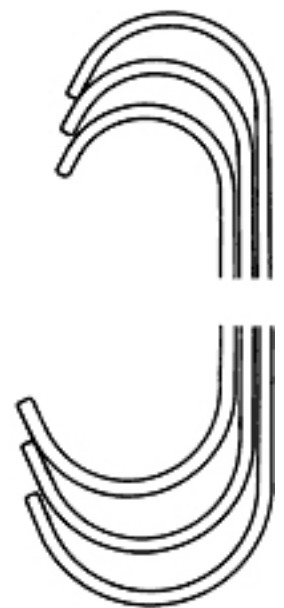

ZI-06-655-03
6 3/4"
Fig. 3



Retractor



Retractor
Farabeuf
ZI-06-663-00
4 1/2"

Fig. 1 – 2
Fig. 2 = 30 x 10 mm
Fig. 1 = 26 x 10 mm
Fig. 1 = 30 x 13 mm
Fig. 2 = 34 x 13 mm



Retractor
Farabeuf
ZI-06-665-00
6"

Fig. 1 – 2
Fig. 2 = 27 x 16 mm
Fig. 1 = 23 x 16 mm
Fig. 1 = 26 x 16 mm
Fig. 2 = 30 x 16 mm



Retractor



Retractor
Roux-Mini
ZI-06-667-06
5 3/4"
8 x 6 mm



Retractor
Roux-Baby
ZI-06-669-13
5"

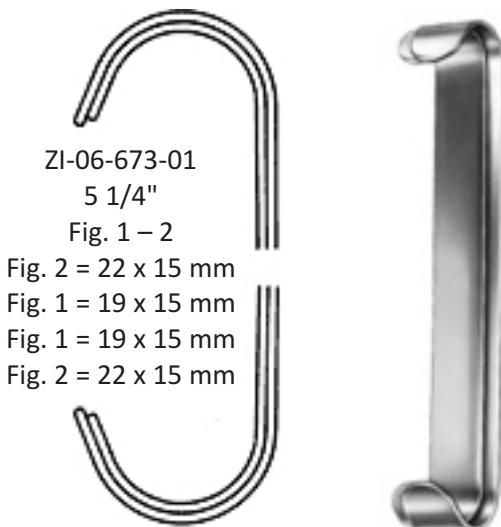

ZI-06-673-01
5 1/4"
Fig. 1 – 2
Fig. 2 = 22 x 15 mm
Fig. 1 = 19 x 15 mm
Fig. 1 = 19 x 15 mm
Fig. 2 = 22 x 15 mm

Retractor
Parker



Retractor



ZI-06-673-02
7"

Fig. 1 – 2
Fig. 2 = 29 x 25 mm
Fig. 1 = 26 x 25 mm
Fig. 1 = 27 x 25 mm
Fig. 2 = 27 x 25 mm



Retractor
Parker

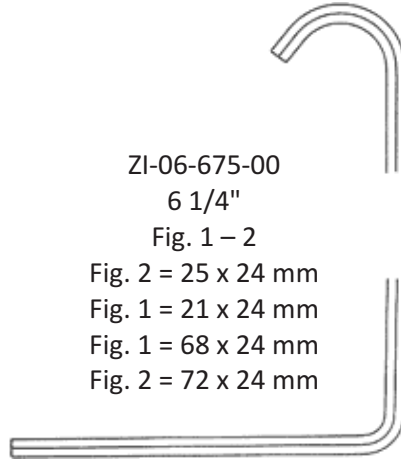

ZI-06-675-00
6 1/4"

Fig. 1 – 2
Fig. 2 = 25 x 24 mm
Fig. 1 = 21 x 24 mm
Fig. 1 = 68 x 24 mm
Fig. 2 = 72 x 24 mm



Retractor
Parker-Mott

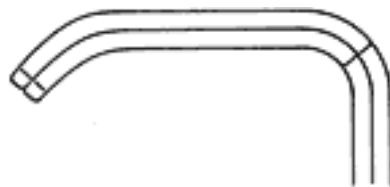

ZI-06-683-00
8" Fig. 1 – 2

Fig. 2 = 47 x 13 mm
Fig. 1 = 42 x 13 mm
Fig. 1 = 42 x 26 mm
Fig. 2 = 46 x 26 mm

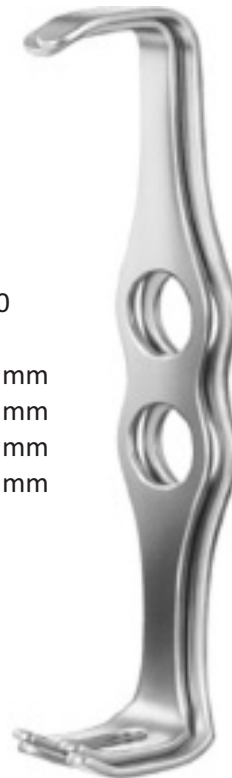

Retractor
Mathieu



Retractor

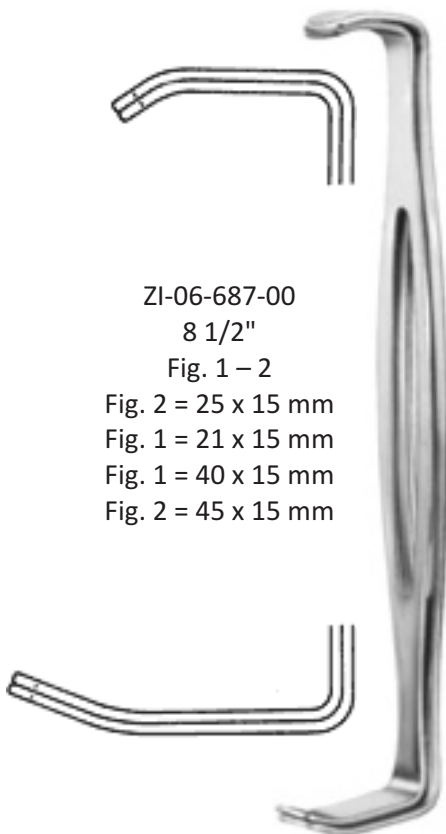

ZI-06-687-00
8 1/2"
Fig. 1 – 2
Fig. 2 = 25 x 15 mm
Fig. 1 = 21 x 15 mm
Fig. 1 = 40 x 15 mm
Fig. 2 = 45 x 15 mm

Retractor
Parker-Langenbeck

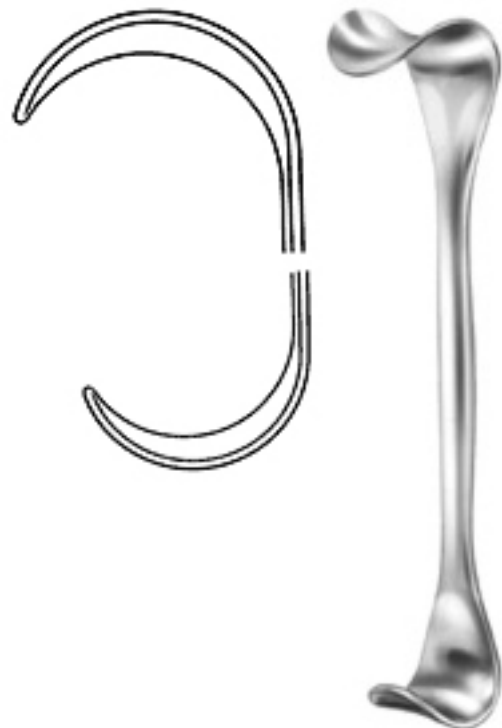

Retractor
Goelet
ZI-06-695-00
7 1/2"
40 x 40 mm
30 x 30 mm



Wound Spreaders
self-retaining
Finsen



ZI-06-700-05
2"
sharp 2 x 3 teeth



ZI-06-701-05
2"
blunt 2 x 3 teeth



ZI-06-702-05
2 3/4"
sharp teeth 3 x 4

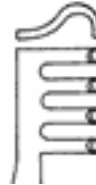

ZI-06-703-05
2 3/4"
blunt 3 x 4 teeth



Wound Spreaders
self-retaining
Finsen-Martin

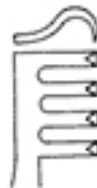

ZI-06-704-07
2 3/4"
sharp 3 x 4 teeth

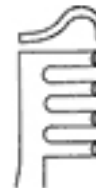

ZI-06-705-07
2 3/4"
blunt 3 x 4 teeth



Retractor



Wound Spreaders, self-retaining
Logan
ZI-06-708-04
1 1/2"
sharp



Fat Spreader
ZI-06-709-30
1 1/4"



Fat Spreader
ZI-06-709-40
1 1/2"

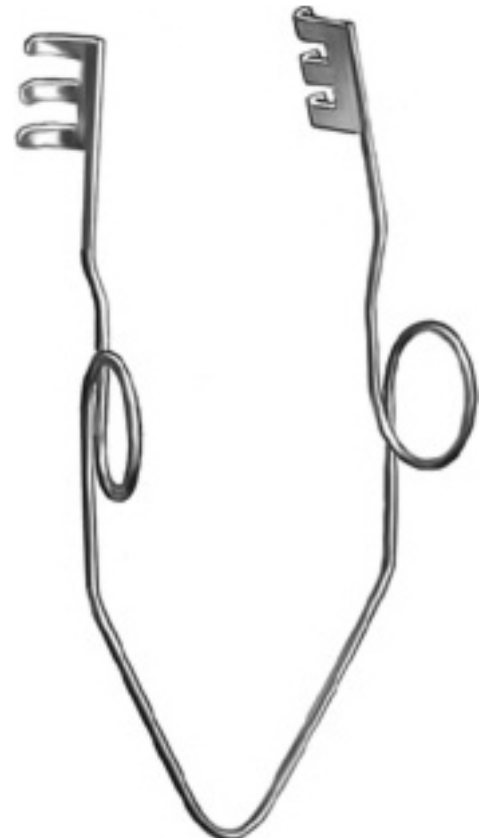
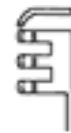

Fat Spreader
ZI-06-709-55
2 1/4"



Retractor



Wound Spreaders, self-retaining
Buckley
ZI-06-710-06
2 1/4"



Wound Spreaders
self-retaining
Alm



ZI-06-714-07
2 3/4"
sharp
4 x 4 teeth



ZI-06-714-10
4 "
sharp
4 x 4 teeth



ZI-06-715-07
2 3/4"
blunt
4 x 4 teeth



ZI-06-715-10
4 "
blunt
4 x 4 teeth



Wound Spreaders, self-retaining
ZI-06-717-10
4 "

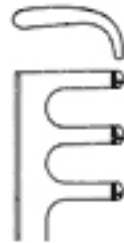

Wound Spreaders, self-retaining
Jansen
ZI-06-723-10
4 "
blunt



ZARYAB
I N S T R U M E N T S

Products that saves life

Retractor



Wound Spreaders, self-retaining
Scalp-Contour



ZI-06-725-14
5 1/4"
sharp
3:4 teeth

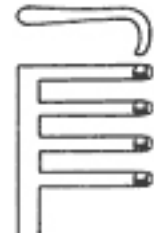

ZI-06-727-14
5 1/4"
blunt
3:4 teeth



ZARYAB
I N S T R U M E N T S

Products that saves life

Retractor

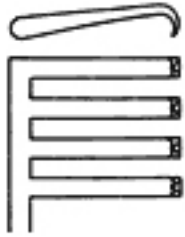

Wound Spreaders, self-retaining
Anderson-Adson
Z1-06-732-20
8"
sharp
4:4 teeth

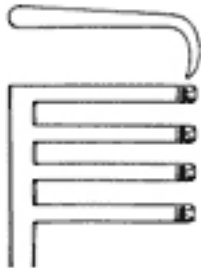

ZI-06-734-20
8"
sharp
3:4 teeth

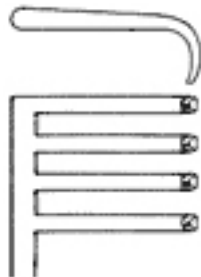

ZI-06-735-20
8"
blunt
3:4 teeth



Wound Spreaders, self-retaining
Weitlaner



Retractor

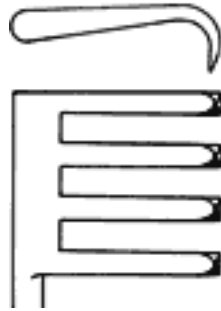

ZI-06-736-26
10 1/4"
sharp
3:4 teeth

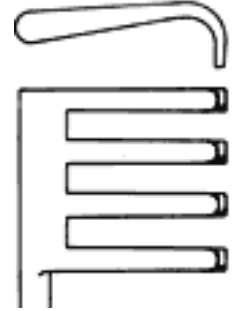

ZI-06-737-26
10 1/4"
blunt
3:4 teeth



Wound Spreaders, self-retaining
Adson

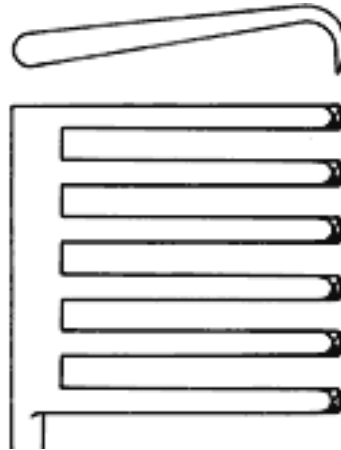

ZI-06-738-26
11 1/2"
sharp
6:6 teeth

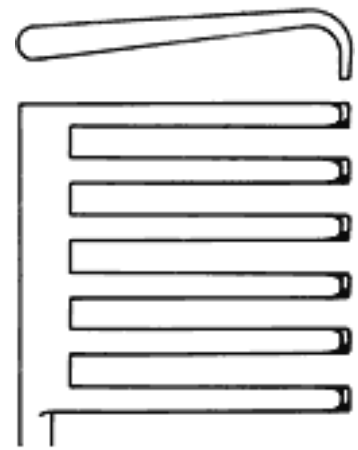

ZI-06-739-26
11 1/2"
blunt
6:6 teeth



ZARYAB
I N S T R U M E N T S

Products that saves life

Retractor



Wound Spreaders, self-retaining
Weitlaner



ZI-06-750-13
5 1/4"
sharp
3:4 teeth

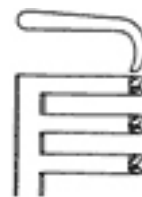

ZI-06-750-16
6 1/4"
sharp
3:4 teeth



Retractor



Wound Spreaders, self-retaining
Weitlaner

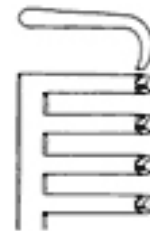

ZI-06-751-13
5 1/4"
blunt
3:4 teeth

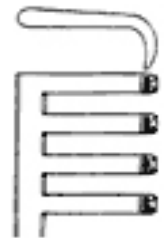

ZI-06-751-16
6 1/4"
blunt
3:4 teeth

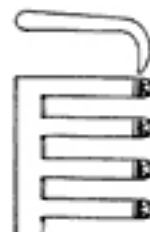

ZI-06-752-13
5"
sharp
3:3 teeth

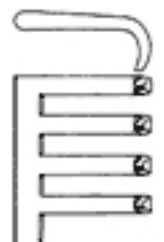

ZI-06-753-16
5"
blunt
3:3 teeth



ZARYAB
INSTRUMENTS

Products that saves life

Retractor



Wound Spreaders, self-retaining
Mollison
ZI-06-754-15
6"
sharp 4:4 teeth



ZI-06-755-13
5"
blunt
2:2 teeth



ZI-06-756-13
5"
sharp
2:2 teeth

Wound Spreaders, self-retaining
Plester



ZI-06-757-11
4"
blunt



ZI-06-759-11
4"
blunt

Wound Spreaders, self-retaining
Plester

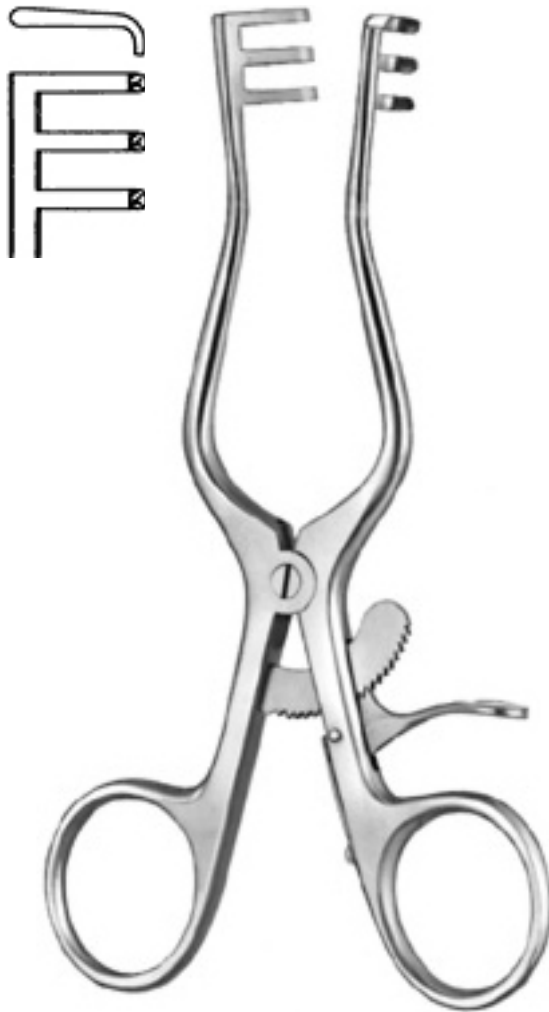

Wound Spreaders, self-retaining
Milligan
ZI-06-765-13
5 1/4"
blunt
3:3 teeth

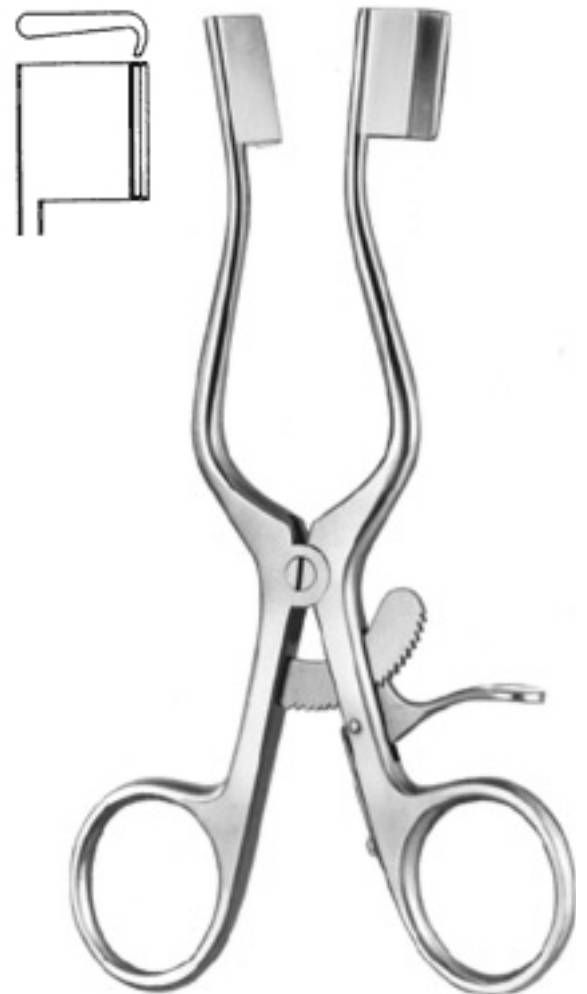

Wound Spreaders, self-retaining
Weitlaner, Baby
ZI-06-767-13
5 1/4"



ZARYAB
INSTRUMENTS

Products that saves life

Retractor



Wound Spreaders, self-retaining
Henley
ZI-06-768-00
6 1/4"
complete with 3 central blades ref.
15-768-19, -25 and -32blunt3:4 prongs



ZARYAB
INSTRUMENTS

Products that saves life

Retractor



Central Blade
Henley



ZI-06-768-19



ZI-06-768-25



ZI-06-768-32



ZARYAB
INSTRUMENTS

Products that saves life

Retractor

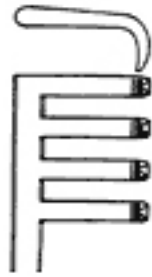

Wound Spreaders, self-retaining

Henley

ZI-06-769-00

6 1/4"

complete with 3 central blades ref. 15-768-19, -25 and -32sharp3:4 prongs



Retractor



Wound Spreaders, self-retaining
Adson

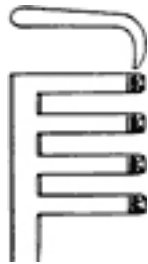

ZI-06-770-13
5 1/4"
sharp3:4 teeth

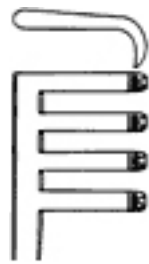

ZI-06-770-16
6 1/2"
sharp3:4 teeth

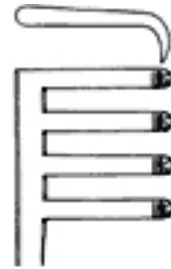

ZI-06-770-20
8 1/4"
sharp3:4 teeth

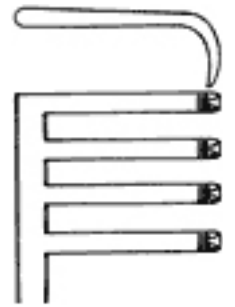

ZI-06-770-26
9 3/4"
sharp3:4 teeth

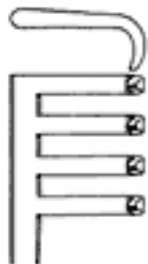

ZI-06-771-13
5 1/4"
blunt3:4 teeth

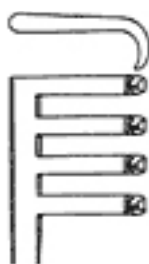

ZI-06-771-16
6 1/2"
blunt3:4 teeth

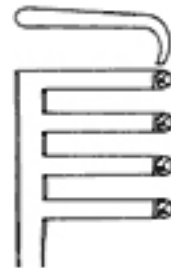

ZI-06-771-20
8 1/4"
blunt3:4 teeth

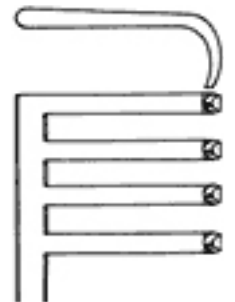

ZI-06-771-26
9 3/4"
blunt3:4 teeth



Retractor



Wound Spreaders, self-retaining
ZI-06-774-00
9 3/4"
completewith 2 each plug-in blades ref.
15-774-40 – 15-774-60



Cloward



Blades, (pair)
ZI-06-774-25
deep 40 mm



Blades, (pair)
ZI-06-774-40
deep 40 mm



Blades, (pair)
ZI-06-774-45
deep 45 mm



Blades, (pair)
ZI-06-774-50
deep 50 mm



Blades, (pair)
ZI-06-774-55
deep 55 mm



Blades, (pair)
ZI-06-774-60
deep 60 mm



Retractor

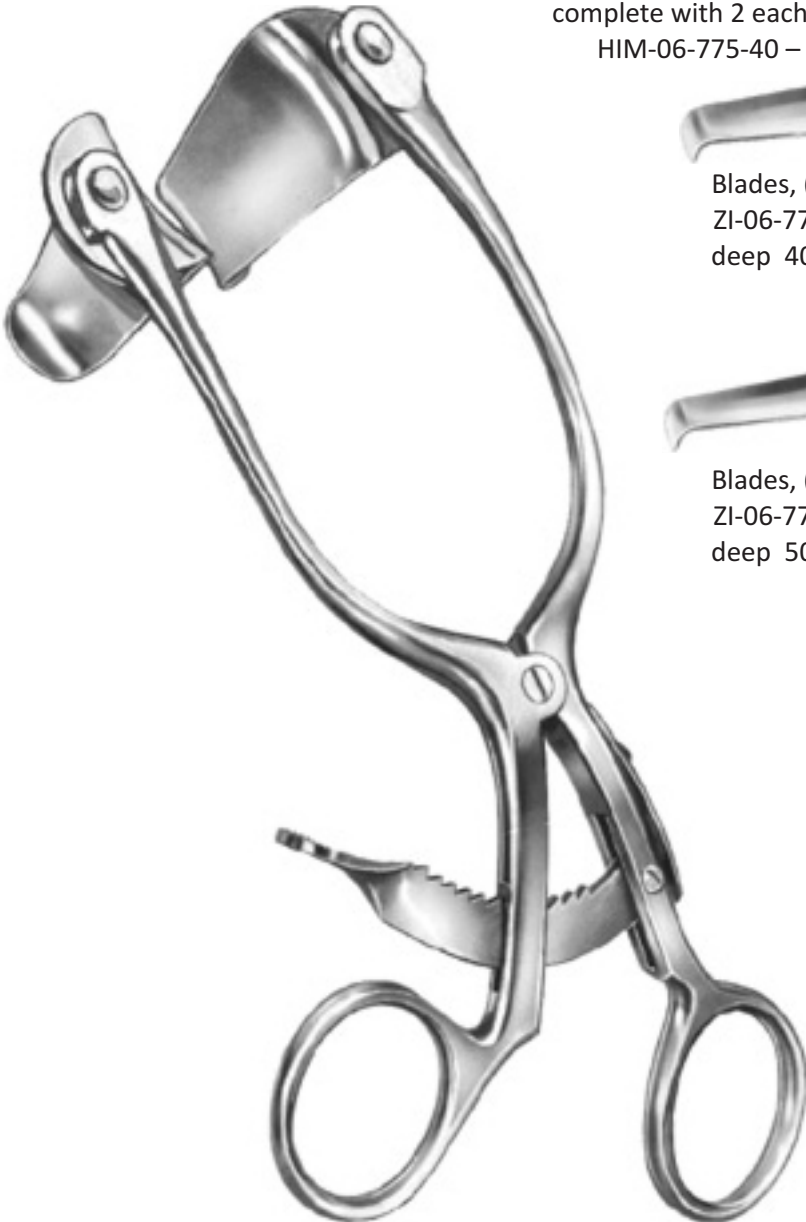

Cloward



Wound Spreaders, self-retaining
ZI-06-775-00
6"

complete with 2 each plug-in blades ref.
HIM-06-775-40 – HIM-06-775-60



Wound Spreaders,
self-retaining
ZI-06-775-15
6"

Spreader only



Blades, (pair)
ZI-06-775-40
deep 40 mm



Blades, (pair)
ZI-06-775-45
deep 45 mm



Blades, (pair)
ZI-06-775-50
deep 50 mm



Blades, (pair)
ZI-06-775-55
deep 55 mm



Blades, (pair)
ZI-06-775-60
deep 60 mm



Products that saves life

Retractor

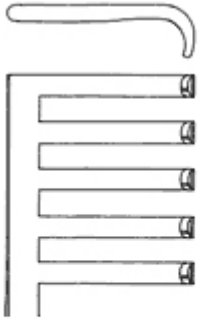

Beckmann
Wound Spreaders
self-retaining
ZI-06-776-31
12 1/2"sharp4:4 teeth

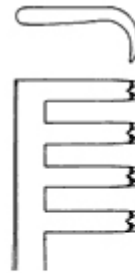

Adson
Wound Spreaders
self-retaining
ZI-06-777-32
13"
blunt4:5 teeth



Retractor



Beckman-Adson
Wound Spreader, self-retaining

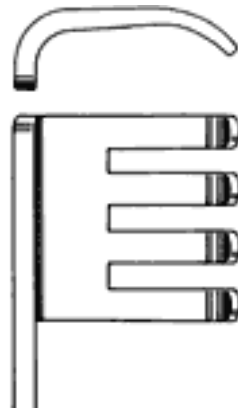

ZI-06-778-00
12"
blunt4:4 teeth

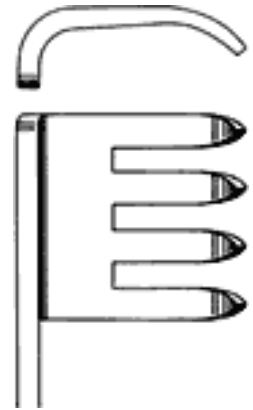

ZI-06-778-01
12"
blunt4:4 teeth

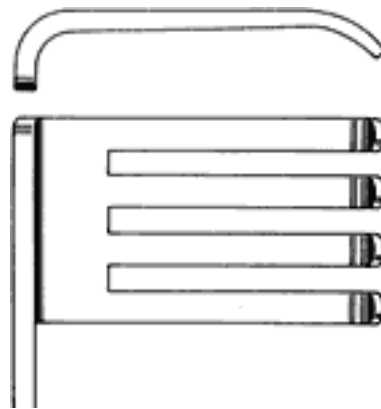

ZI-06-778-02
12"
blunt4:4 teeth

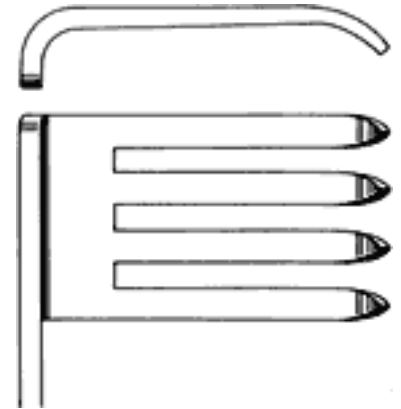

ZI-06-778-03
12"
blunt4:4 teeth



ZARYAB
INSTRUMENTS

Products that saves life

Retractor

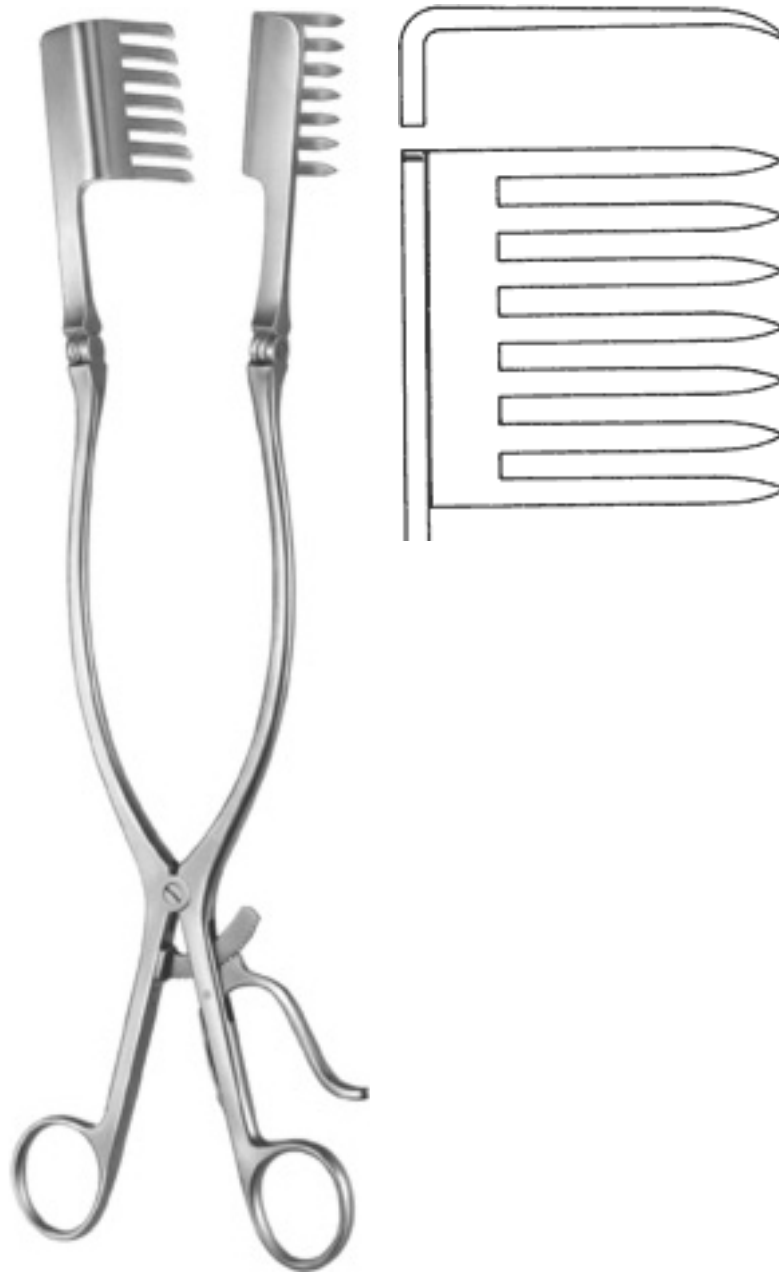

Beckman-Eaton
Wound Spreaders, self-retaining
ZI-06-778-32
12 1/2"
sharp 7:7 teeth



Retractor

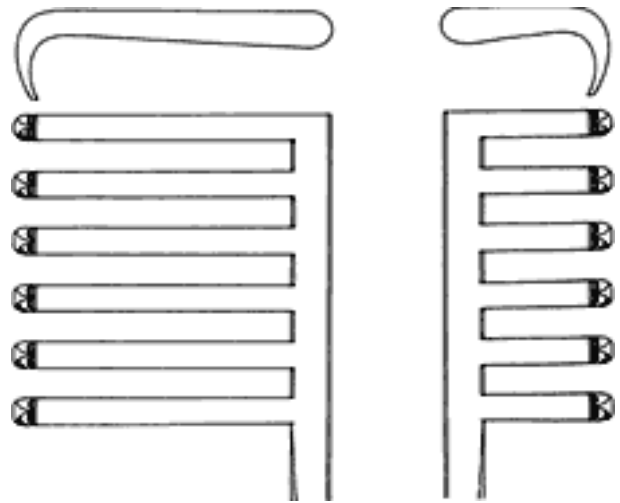

Wound Spreaders, self-retaining
ZI-06-790-01
11 1/4"
teeth6:6 teeth



Martin

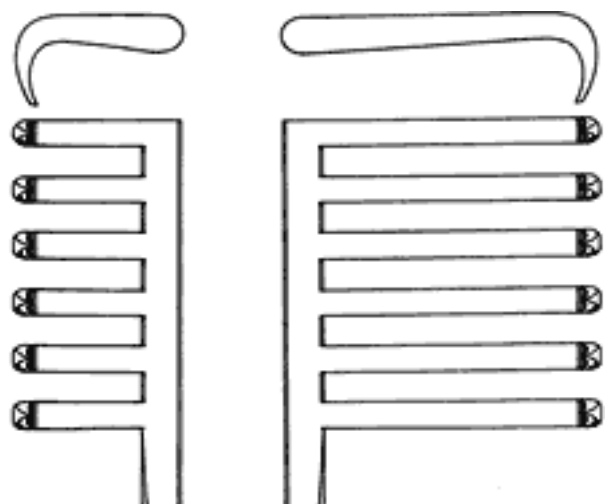

Wound Spreaders, self-retaining
ZI-06-790-02
11 1/4"
teeth6:6 teeth

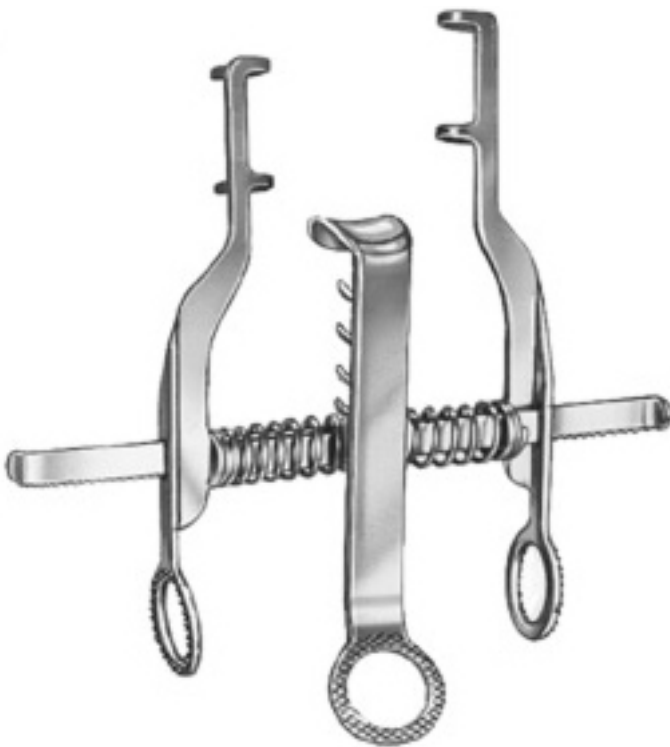

Vickers Low-Profile
Wound Spreader, self-retaining
ZI-06-792-00
3"
complete, with central blade ref.
15-792-01

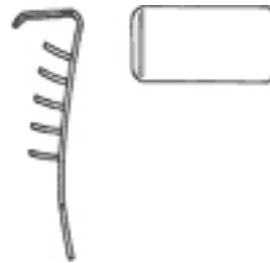

Central Blade
ZI-06-792-01
2 1/2"
10 x 18 mm



Central Blade
ZI-06-792-02
2 1/2"
12 x 10 mm



ZARYAB
I N S T R U M E N T S

Products that saves life

Retractor



Wound Spreaders, self-retaining
Vickers Low-Profile
ZI-06-793-00
3 1/2"
complete, with central blade ref. 15-792-01



Wound Spreaders, self-retaining
Vickers Low-Profile
ZI-06-794-00
3"
complete, with central blade ref. 15-792-01



ZARYAB
I N S T R U M E N T S

Products that saves life

Retractor



Wound Spreaders, self-retaining
Vickers

ZI-06-798-01
2"

blunt, ring model, for thumb and fingers



Thyroid and Vaginal retractor
Joll

ZI-06-801-00
6"



Wound Spreaders, self-retaining
Gelpi
ZI-06-802-13
5"

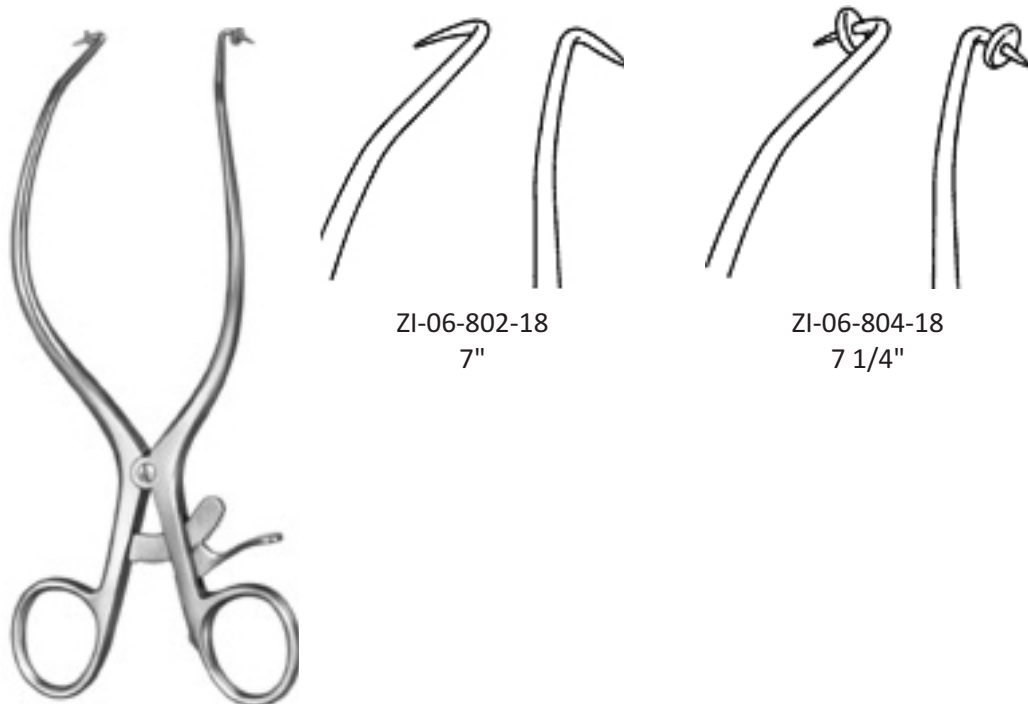

ZI-06-802-18
7"

ZI-06-804-18
7 1/4"

Wound Spreaders, self-retaining
Gelpi



ZARYAB
I N S T R U M E N T S

Products that saves life

Retractor



Abdominal Retractor

Collin, Baby

ZI-06-820-00

8

complete, with 2 pairs of lateral blades ref.15-839-18 (18 x 40 mm) and 15-839-27 (27 x 40 mm)



Abdominal Retractor
Collin
ZI-06-822-22
9 1/4

complete, with 1 pair of lateral blades ref
.15-839-38 (38 x 60 mm)



Abdominal Retractor
Collin
ZI-06-823-00
9"

complete, with 1 pair of lateral blades ref.
15-839-38 (38 x 60 mm) and central blade 38 x 55 mm



Abdominal Retractor
Collin

ZI-06-826-00
12 1/4"

complete, with 1 pair of lateral blades ref.
15-839-60 (60 x 80 mm)
and central blade 60 x 75 mm



Abdominal Retractor
Ricard

ZI-06-828-00

complete with 1 pair of lateral blades ref.
15-839-90 and central blade ref
15-830-02



ZARYAB
I N S T R U M E N T S

Products that saves life

Retractor



Spreader, only
Ricard
ZI-06-828-01

Abdominal Retractor
Ricard
ZI-06-830-00
complete with 1 pair of lateral blades ref.
15-839-92
and central blade ref.
15-830-04

Central Blade
Ricard
ZI-06-830-02
55 x 70 mm

Central Blade
Ricard
ZI-06-830-04
80 x 90 mm



ZARYAB
INSTRUMENTS

Products that saves life

Retractor



ZI-06-839-18
18 x 40 mm

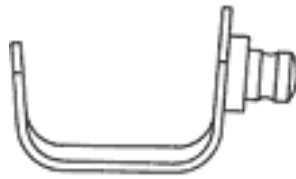

ZI-06-839-27
27 x 40 mm

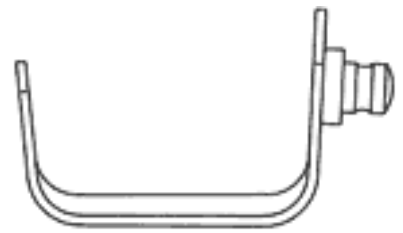

ZI-06-839-38
38 x 60 mm



Lateral Blade

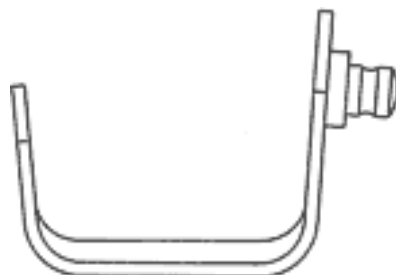

ZI-06-839-40
40 x 80 mm

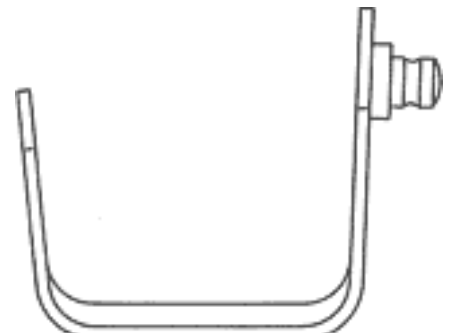

ZI-06-839-45
45 x 80 mm



Retractor

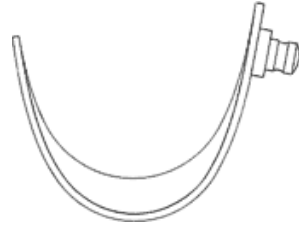

ZI-06-839-50
50 x 70 mm

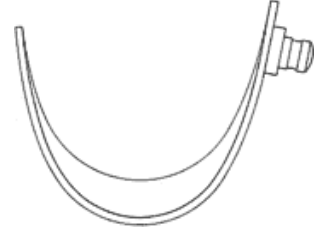

ZI-06-839-52
52 x 110 mm

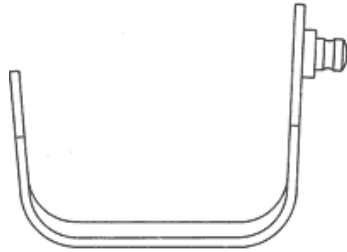

ZI-06-839-60
60 x 80 mm



ZI-06-839-70
70 x 55 mm



Lateral Blade

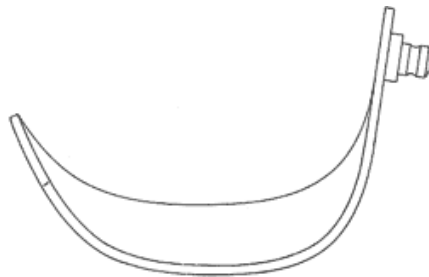

ZI-06-839-80
75 x 90 mm

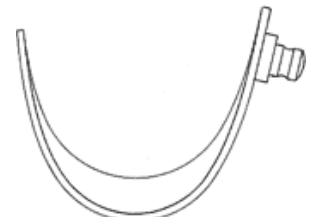

ZI-06-839-90
50 x 58 mm

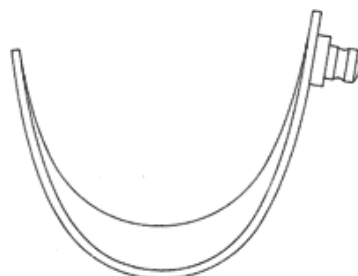

ZI-06-839-92
60 x 80 mm



ZI-06-839-94
72 x 85 mm



Abdominal Retractor
Gosset-Baby
ZI-06-840-00
5"
spreading 100 mmlateral blades
40 x 30 mm



Abdominal Retractor
Gosset
ZI-06-844-00
6 1/2"
spreading 160 mmlateral blades 63 x 35 mm
1 central blade 60 x 56 mm



Retractor

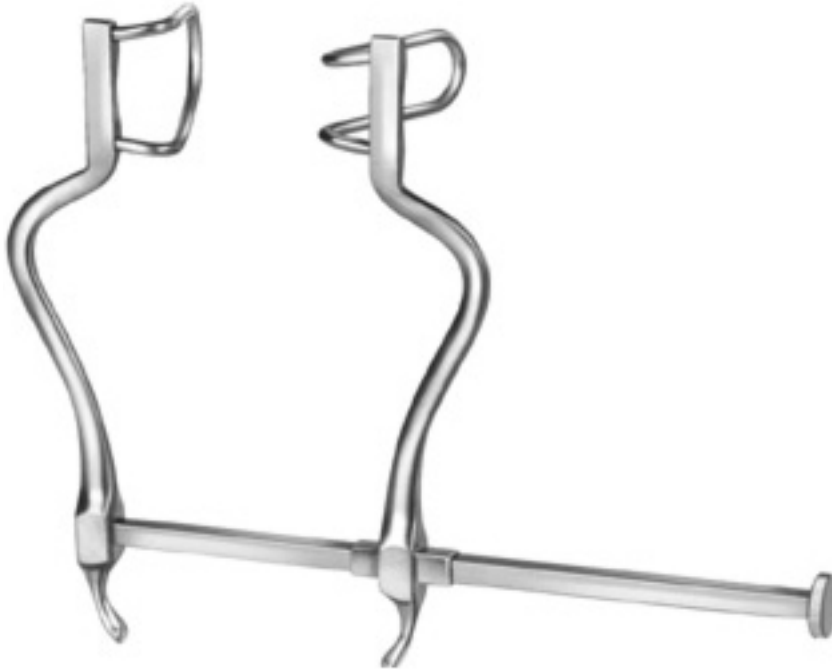

Abdominal Retractor
Gosset
ZI-06-846-00
7 1/4"
spreading 140 mm lateral blades 63 x 35 mm



Abdominal Retractor
Balfour-Baby
HIM-06-850-00
5"
spreading 90 mm 1 central blade 24 x 20 mm

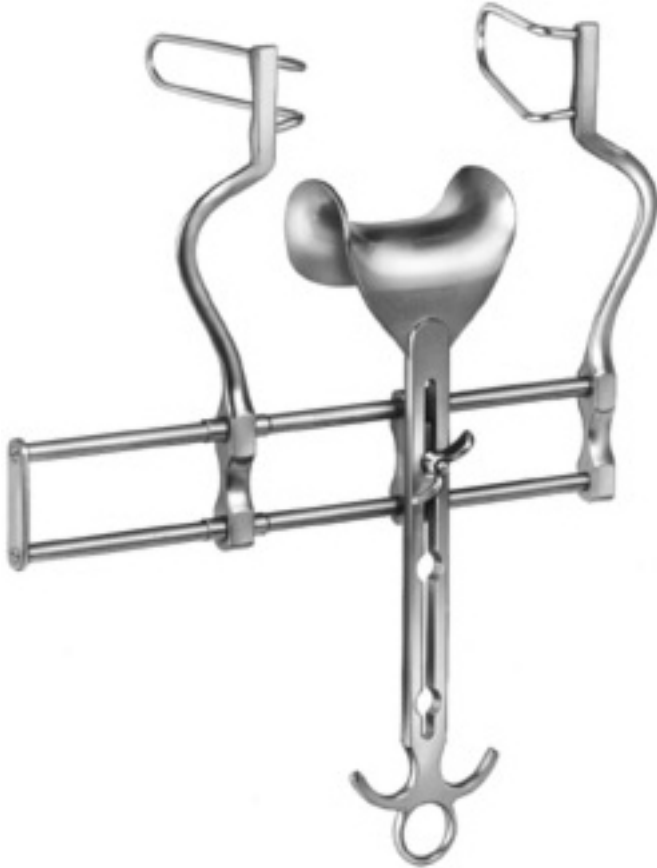

Abdominal Retractor
Balfour
ZI-06-852-00
8"

spreading 180 mmlateral blades 70 x 35 mm1
central blade ref.
15-859-01

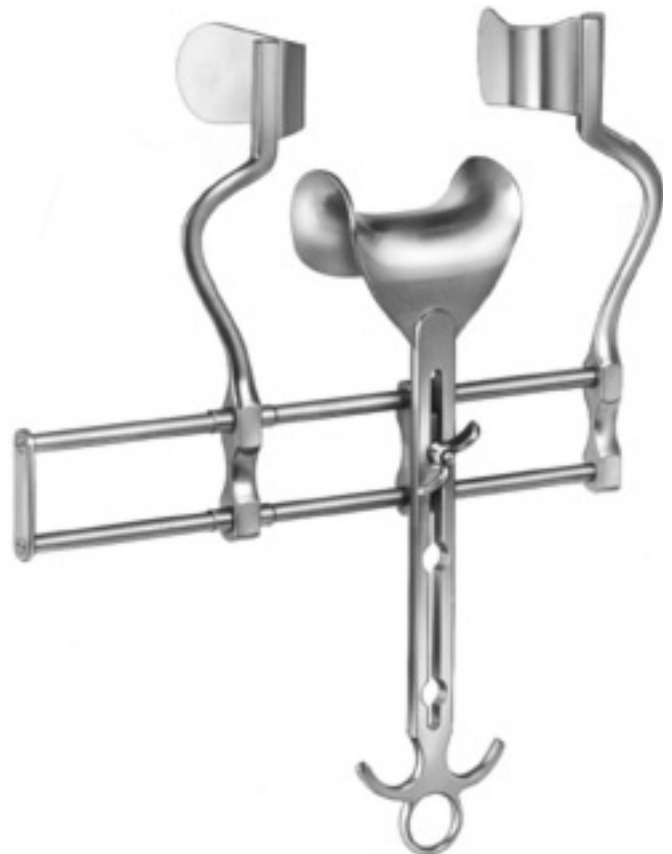

Abdominal Retractor
Balfour
ZI-06-854-00
8"

spreading 180 mmlateral blades 70 x 35 mm1
central blade ref
15-859-01



Abdominal Retractor
Balfour
ZI-06-856-00
8"
spreading 200 mm lateral blades
100 x 35 mm 1 central blade
100 x 60 mm

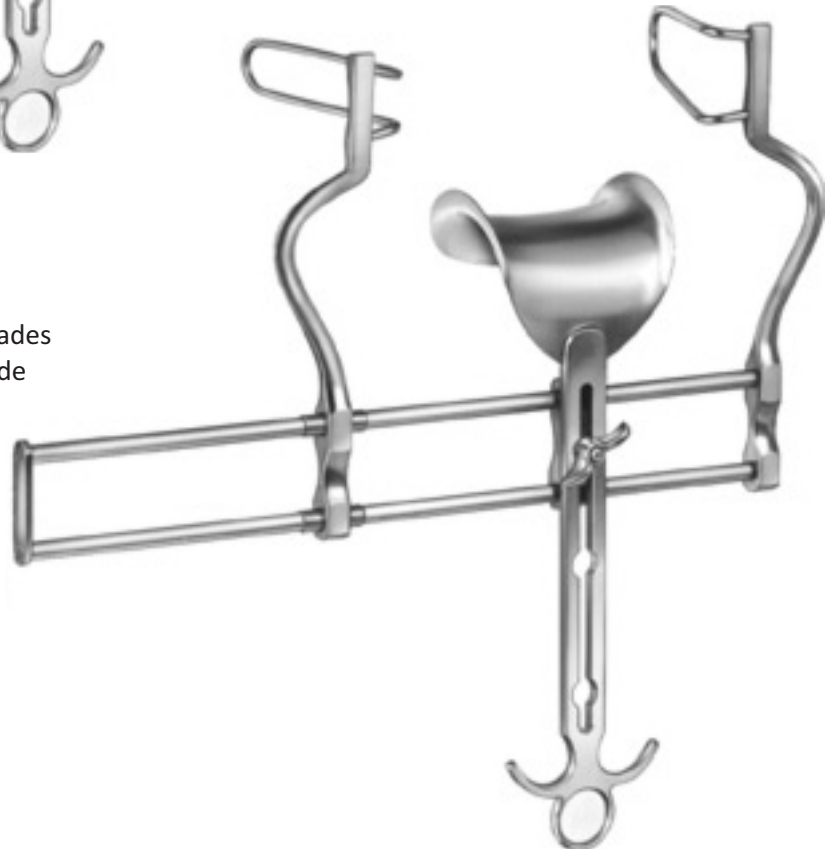

Abdominal Retractor
Balfour
ZI-06-856-00
8"
spreading 250 mm lateral
blades 100 x 35 mm 1
central blade ref
15-859-02



ZARYAB
I N S T R U M E N T S

Products that saves life

Retractor



Central Blade
Balfour
ZI-06-859-01
45 x 80 mm



Central Blade
Balfour
ZI-06-859-02
68 x 85 mm



Central Blade
Balfour
ZI-06-859-05
68 x 85 mm



Central Blade
Balfour
ZI-06-859-06
40 x 68 mm



ZARYAB
I N S T R U M E N T S

Products that saves life

Retractor



Abdominal Retractor

Balfour, Modell USA

ZI-06-860-00

with 2 pairs of each lateral blades ref

15-860-06 and 15-860-08

and 1 central blade ref

15-859-05



Fenestrated Blade
Balfour, Modell USA
ZI-06-860-06
60 mm deep (pair)



Fenestrated Blade
Balfour, Modell USA
ZI-06-860-08
80 mm deep (pair)



Abdominal Retractor
O'Sullivan-O'Connor
ZI-06-868-00
with 2 fixed lateral blades
1 blade 110 x 70 mm
and 2 blades 80 x 45 mm



ZARYAB
I N S T R U M E N T S

Products that saves life

Retractor



Abdominal Retractor

Kirschner

ZI-06-882-00

oval frame ref. 15-882-30 (300 x 240 mm), 3 hooks ref. 15-889-50



Frame

Kirschner

ZI-06-882-30

340 x 240 mm



Abdominal Retractor

Kirschner

ZI-06-884-00

frame 15-884-24, 2 hooks 15-889-40 and 2 hooks ref. 15-889-50



Frame, only

Kirschner

ZI-06-884-24

240 x 240 mm



Retractor

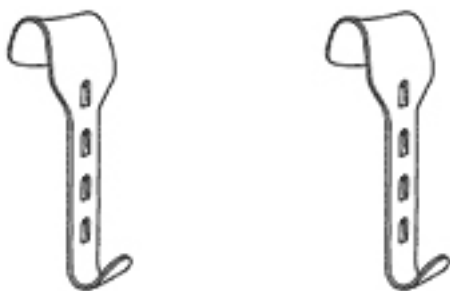

Blade
Kirschner
ZI-06-889-40
40 x 55 mm Standard



Blade
Kirschner
ZI-06-889-50
50 x 65 mm Standard



Blade
Kirschner
ZI-06-889-60
60 x 85 mm Standard



Blade
Kirschner
ZI-06-889-78
78 x 65 mm
for obese patients

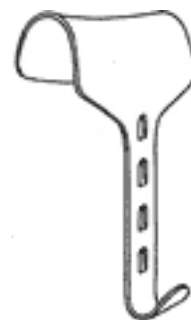

Blade
Kirschner
ZI-06-889-80
80 x 90 mm
for obese patients



Retractor



Blade
Kirschner
ZI-06-889-98
98 x 50 mm for intestine and bladder



Blade
Kirschner
ZI-06-889-99
105 x 35 mm for intestine and bladder



Abdominal Retractor
ZI-06-898-00
255 mm \varnothing round, complete with 4 blades ref. 15-898-05



Blade
ZI-06-898-05
50 x 65 mm



ZARYAB
I N S T R U M E N T S

Products that saves life

Retractor



Blade
ZI-06-898-07
75 x 65 mm



Spare Button
ZI-06-898-10



Frame, only
ZI-06-898-12
255 mm Ø



ZARYAB
I N S T R U M E N T S

Products that saves life

Retractor



Laminectomy Retractor
Scoville
ZI-06-906-00
6"
spreading 150 mm



Retractor



Hook
Scoville
ZI-06-906-01
50 mm deep
blunt



Hook
Scoville
ZI-06-906-02
70 mm deep
blunt



Hook
Scoville
ZI-06-906-06
50 mm deep
blunt



Hook
Scoville
ZI-06-906-07
70 mm deep
blunt



Blade
Scoville
ZI-06-906-11
60 x 25 mm
toothed



Blade
Scoville
ZI-06-906-12
64 x 50 mm
toothed



Blade
Scoville
ZI-06-906-13
88 x 25 mm
toothed



Hook
Taylor
ZI-06-906-41
48 x 50 mm
sharp



Hook
Taylor
ZI-06-906-42
64 x 50 mm
sharp



Hook
Taylor
ZI-06-906-43
64 x 64 mm
sharp



Hook
Taylor
ZI-06-906-44
80 x 57 mm
sharp



Hook
Taylor
ZI-06-906-46
41 x 38 mm
sharp



Hook
Taylor
ZI-06-906-47
67 x 44 mm
sharp



ZARYAB
I N S T R U M E N T S

Products that saves life

Retractor



Laminectomy Retractor
Scoville-Haverfield
ZI-06-906-50
6"
spreading 150 mm



ZARYAB
I N S T R U M E N T S

Products that saves life

Retractor



Martin Arm System
Martin
ZI-06-910-01



Universal Fixation Clamp
Martin
ZI-06-910-50
for Martin Arm and Martin-Rochard System



ZARYAB
I N S T R U M E N T S

Products that saves life

Retractor

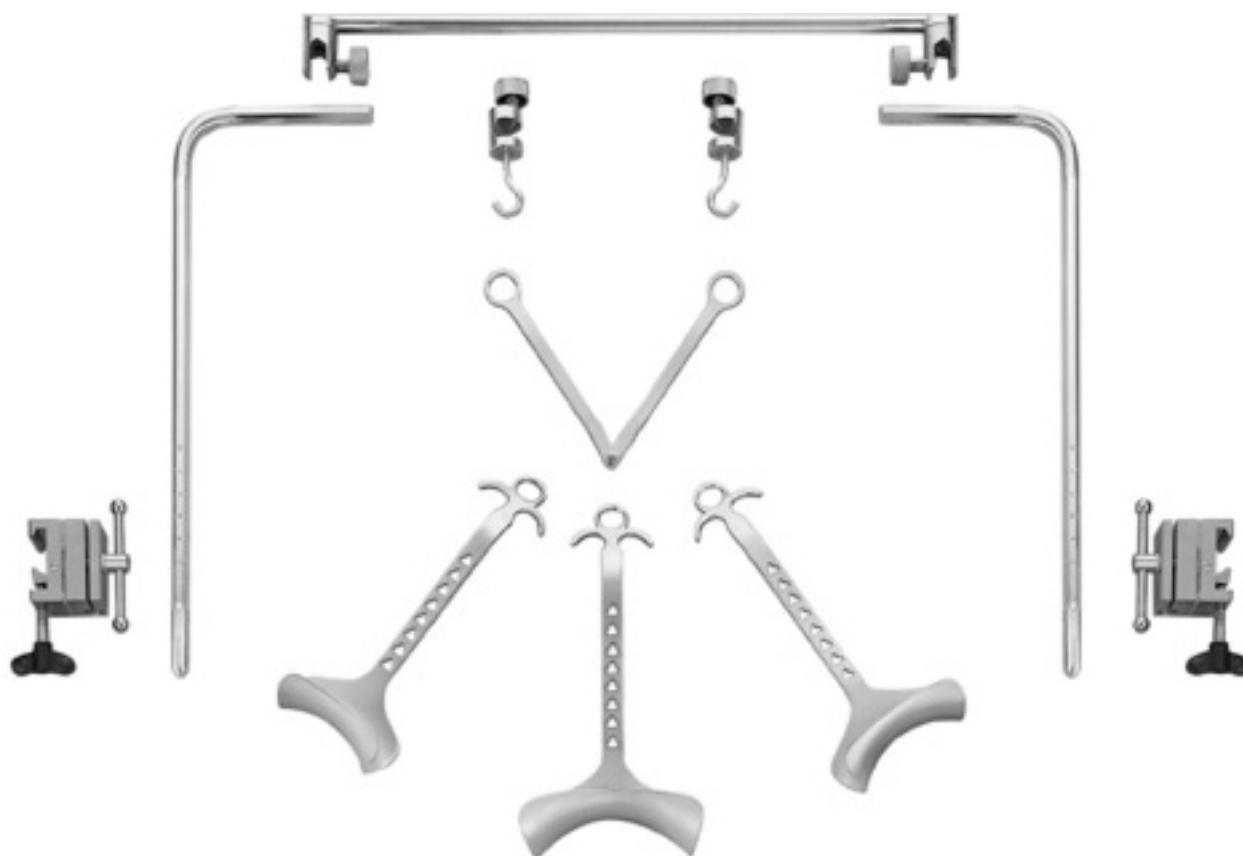

Retractor System
Martin-Rochard
ZI-06-917-00
complete

Fixation Arm
Martin-Rochard
ZI-06-917-01
lateral

Cross Bar
Martin-Rochard
ZI-06-917-02
hexagon

Sliding Clamp
Martin-Rochard
ZI-06-917-03
complete

Fixing device for hooks
Martin-Rochard
ZI-06-917-04
7 1/4"

Retractor
Martin-Rochard
ZI-06-917-10
47 x 105 mm

Retractor
Martin-Rochard
ZI-06-917-12
50 x 120 mm

Retractor
Martin-Rochard
ZI-06-917-15
50 x 155 mm



ZARYAB
I N S T R U M E N T S

Products that saves life

Retractor



Abdominal Spatula
ZI-06-963-01
13"
30 mm wide

Abdominal Spatula
ZI-06-963-02
13"
40 mm wide

Abdominal Spatula
ZI-06-963-02
13"
50 mm



ZARYAB
I N S T R U M E N T S

Products that saves life

Retractor



Abdominal Spatula
Haberer
ZI-06-971-00
8"
17 – 25 mm

Abdominal Spatula
Haberer
ZI-06-971-01
11"
25 – 30 mm

Abdominal Spatula
Haberer
ZI-06-971-02
11 3/4"
37 – 45 mm



ZARYAB
I N S T R U M E N T S

Products that saves life

Retractor



Abdominal Spatula
Martin
ZI-06-975-06
8"
6,5 mm wide

Abdominal Spatula
Martin
ZI-06-975-09
8"
9,5 mm wide

Abdominal Spatula
Martin
ZI-06-975-13
8"
13 mm wide

Abdominal Spatula
Martin
ZI-06-975-16
8"
16 mm wide

Abdominal Spatula
Martin
ZI-06-975-19
8"
19 mm wide

Abdominal Spatula
Martin
ZI-06-975-25
8"
25 mm wide



Products that saves life

ZARYAB

I N S T R U M E N T S

 Harar, Wazirabad Road, Sialkot-51310, Pir Sabz Rd, Pir Sabz, Pakistan

 +92 52 3573775

 +92 52 3573776

 +92 333 8608580 , +92 333 3349600

 info@zaryabinstruments.com

 sales@zaryabinstruments.com

 www.zaryabinstruments.com