



Products that saves life

ZARYAB

INSTRUMENTS



FORCEPS

Catalogue





ZARYAB
INSTRUMENTS

Products that saves life

Forceps



ZI-03-100-10
4"

ZI-03-100-11
4 1/2"

ZI-03-100-13
5"

ZI-03-100-14
5 3/4"

ZI-03-100-16
6 1/4"

ZI-03-100-18
7"

ZI-03-100-20
8"

ZI-03-100-23
9"

ZI-03-100-25
9 3/4"

ZI-03-100-30
12"

Dressing Forceps
standard pattern



Forceps



ZI-03-120-11
4 3/4"



ZI-03-120-13
5"



ZI-03-120-14
5 3/4"



ZI-03-120-16
6 1/4"



ZI-03-120-18
7"



ZI-03-120-20
8"



ZI-03-120-25
9 3/4"



ZI-03-120-30
11 3/4"

Dressing Forceps
standard pattern



Forceps



Dressing Forceps
ZI-03-126-13
5"
standard pattern



Dressing Forceps
ZI-03-126-14
5 3/4"
standard pattern



Dressing Forceps
ZI-03-130-15
6"



ZARYAB
INSTRUMENTS

Products that saves life

Forceps



Mini-Adson Dressing Forceps
ZI-03-166-12
4 3/4"



Adson Dressing Forceps
ZI-03-168-12
4 3/4"



Adson Dressing Forceps
ZI-03-168-15
6"



Forceps

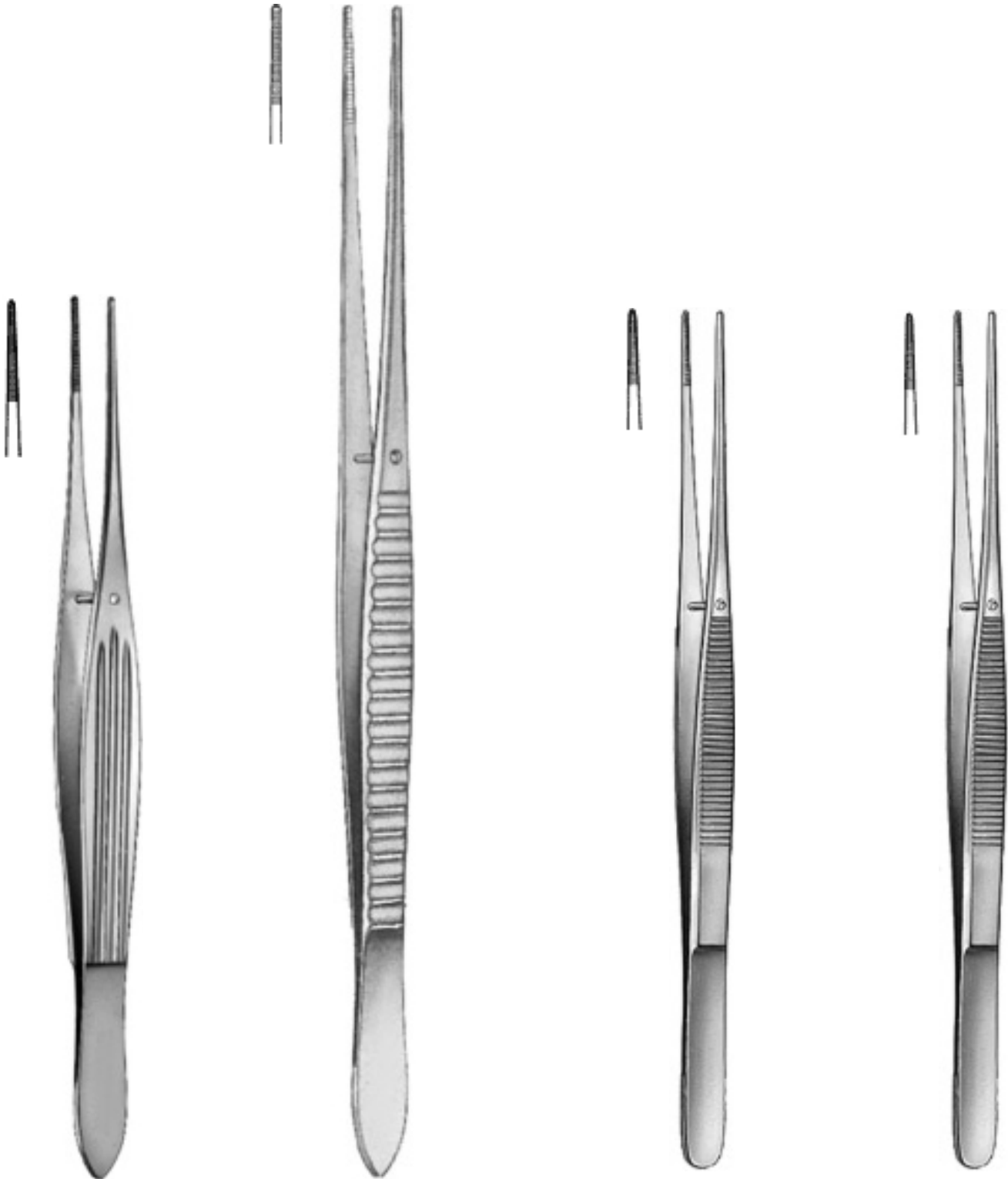

McIndoe Dressing Forceps
ZI-03-170-15
6"

Waugh Dressing Forceps
ZI-03-171-20
8"

Semken Dressing Forceps
ZI-03-172-12
5"

Semken Dressing Forceps
ZI-03-172-15
6"



ZARYAB
INSTRUMENTS

Products that saves life

Forceps



Taylor Dressing Forceps
ZI-03-174-17
6 3/4"



Taylor Dressing Forceps
ZI-03-180-17
6 3/4"
with dissector end



Taylor Dressing Forceps
ZI-03-183-17
7 1/4"
with dissector end



Forceps

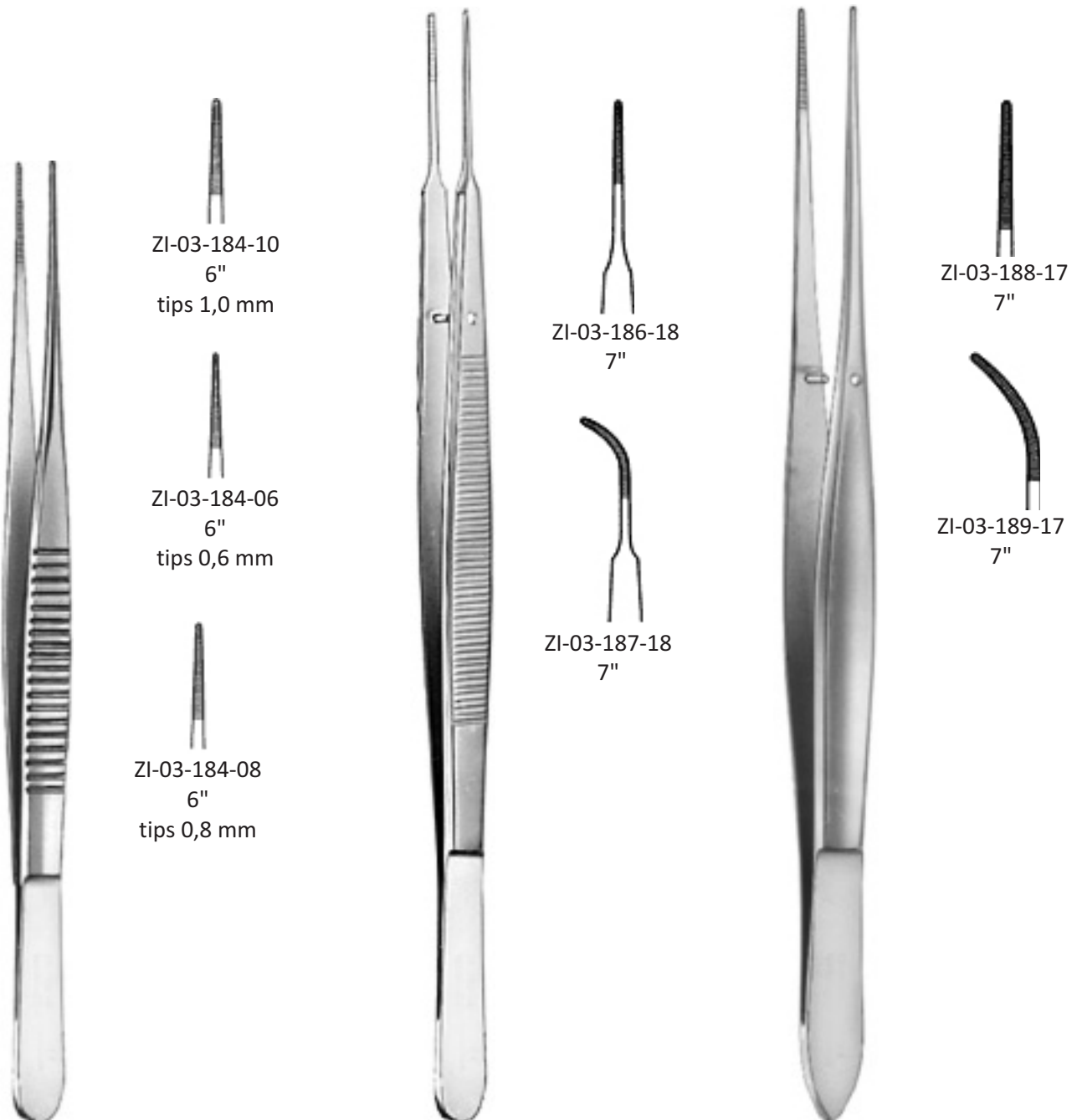

Micro Dressing Forceps

Gerald Dressing Forceps

Cushing Dressing Forceps



Potts-Smith Dressing Forceps



ZI-03-192-18
7"

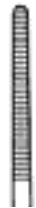

ZI-03-192-21
8 1/4"



ZI-03-192-25
9 3/4"



Bonney Dissecting Forceps
ZI-03-230-17
7"

1:2 teethnormal profile



Gerald Dissecting Forceps
ZI-03-234-17
7"

1:2 teethmini profile



Gillies Dissecting Forceps
ZI-03-236-15
6"
1:2 teeth
mini profile



McIndoe Dressing Forceps
ZI-03-238-15
6"
mini profile



Semken Dissecting Forceps



ZI-03-240-16
6"
normal profile 1:2 teeth



ZI-03-242-16
6"
mini profile 1:2 teeth



ZI-03-240-18
7"
normal profile 1:2 teeth



ZI-03-242-18
6"
mini profile 1:2 teeth



ZI-03-240-16
6"

normal profile 1:2 teeth



ZI-03-242-16
6"

mini profile 1:2 teeth



ZI-03-240-18
7"

normal profile 1:2 teeth



ZI-03-242-18
6"

mini profile 1:2 teeth



Semken Dissecting Forceps



Adson-Brown Dissecting Forceps
ZI-03-244-12
4 3/4"
normal profile



Adson Dissecting Forceps



ZI-03-246-12
4 3/4"



ZI-03-246-15
6"



ZI-03-250-12
4 3/4"



ZI-03-250-15
6"



ZARYAB
I N S T R U M E N T S

Products that saves life

Forceps

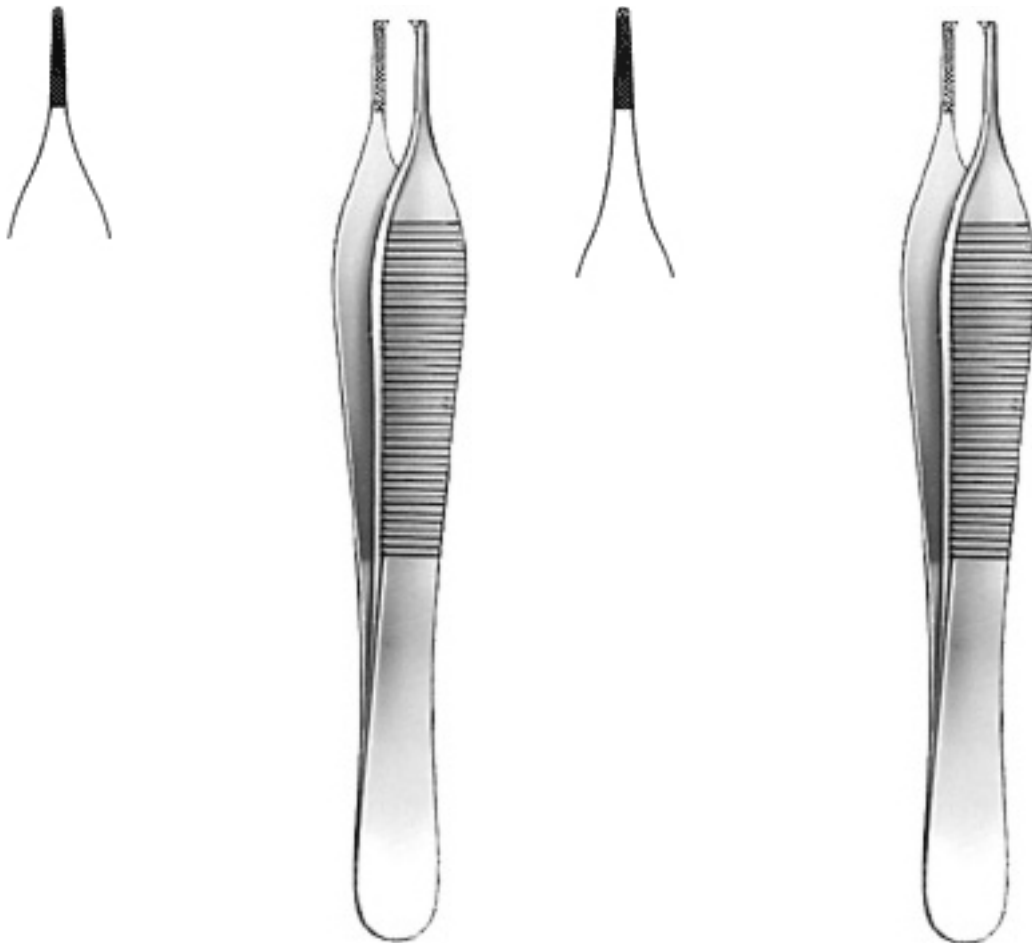

Adson Dissecting Forceps
ZI-03-252-12
6"
normal profile 1:2 teeth

Adson Dissecting Forceps
ZI-03-252-15
6"
normal profile 1:2 teeth



Cushing Dressing Forceps
ZI-03-254-17
7"
normal profile



Cushing Dressing Forceps
ZI-03-255-18
6 3/4"
normal profile



Cushing-Taylor Dressing Forceps
ZI-03-256-18
7 1/4"
normal profile



Forceps



ZI-03-258-15
6 1/4"

ZI-03-258-18
7 1/4"

ZI-03-258-20
8"

ZI-03-258-23
9"

ZI-03-258-25
9 3/4"



ZI-03-260-14
5 3/4"

ZI-03-260-25
9 3/4"

ZI-03-260-16
6 1/4"

ZI-03-260-18
7"

ZI-03-260-20
8"



ZI-03-266-15
6"



ZI-03-266-23
9"



Wangensteen Dressing Forceps



ZI-03-270-15
6 1/4"
micro profile 1,6 mm



ZI-03-270-19
8"
micro profile 1,6 mm



ZI-03-270-24
9 3/4"
micro profile 1,6 mm



ZI-03-272-15
6 1/4"
mini profile 2,0 mm



ZI-03-272-19
8"
mini profile 2,0 mm



ZI-03-272-24
9 3/4"
mini profile 2,0 mm



JABOMA Dressing
Forceps
ZI-03-276-18
7"



JABOMA Dressing
Forceps
ZI-03-278-18
7"
1:2 teeth



JABOMA Dressing
Forceps
ZI-03-279-18
7"
1:2 teeth



ZI-03-282-16
6 1/4"
jaw 1,5 mm



ZI-03-282-20
8"
jaw 1,5 mm



ZI-03-282-24
9 1/2"
jaw 1,5 mm



ZI-03-284-16
6 1/4"
jaw 1,8 mm



ZI-03-284-20
8"
jaw 1,8 mm



ZI-03-284-24
9 1/2"
jaw 1,8 mm

DeBakey Atraumatic
Dressing Forceps



Forceps



ZI-03-301-10
4"
1:2 teeth



ZI-03-301-11
4 1/2"
1:2 teeth



ZI-03-301-13
5"
1:2 teeth



ZI-03-301-14
5 3/4"
1:2 teeth



ZI-03-301-16
6 1/4"
1:2 teeth



ZI-03-301-18
7"
1:2 teeth



ZI-03-301-20
8"
1:2 teeth



ZI-03-301-23
9"
1:2 teeth



ZI-03-301-25
9 3/4"
1:2 teeth



ZI-03-301-30
12"
1:2 teeth



Dissecting Forceps



ZI-03-302-11
4 3/4"
2:3 teeth



ZI-03-302-13
5"
2:3 teeth



ZI-03-302-14
5 3/4"
2:3 teeth



ZI-03-302-16
6"
2:3 teeth



ZI-03-302-18
7"
2:3 teeth



ZI-03-302-20
8"
2:3 teeth



ZI-03-302-25
9 3/4"
2:3 teeth



Dissecting Forceps



ZI-03-303-14	ZI-03-303-16
5 3/4"	6 1/4"
3:4 teeth	3:4 teeth



ZI-03-304-14	ZI-03-304-16
5 3/4"	6 1/4"
4:5 teeth	4:5 teeth



Dissecting Forceps



ZI-03-321-13
5"
1:2 teeth
slender pattern



ZI-03-321-14
5 3/4"
1:2 teeth
slender pattern



ZI-03-321-16
6 1/4"
1:2 teeth
slender pattern



ZI-03-321-20
8"
1:2 teeth
slender pattern



Forceps



ZI-03-326-13
5 3/4"
1:2 teeth



ZI-03-326-14
5 1/2"
1:2 teeth



ZI-03-331-15
6"
1:2 teeth



ZI-03-332-15
6"
2:3 teeth



Stone Dissecting Forceps
ZI-03-364-15
6"
4:5 teeth



Lerche Dissecting Forceps
ZI-03-365-15
6"
5:6 teeth



Forceps



ZI-03-366-15
6"
2:3 teeth



ZI-03-366-20
8"
2:3 teeth



ZI-03-367-15
6 1/4"
4:5 teeth



ZI-03-367-20
8"
4:5 teeth



ZI-03-367-25
9 3/4"
4:5 teeth



Forceps



Adson Dissecting Forceps



ZI-03-368-12
4 3/4"
1:2 teeth



ZI-03-368-15
4 3/4"
1:2 teeth



Gillies Dissecting Forceps
ZI-03-370-15
6"
1:2 teeth



Waugh Dissecting Forceps
ZI-03-371-20
8"
1:2 teeth



Forceps



ZI-03-372-12
5"
1:2 teeth

ZI-03-372-15
6"
1:2 teeth



Taylor Dissecting Forceps

ZI-03-374-17
7"
1:2 teeth

ZI-03-380-17
6 3/4"
1:2 teeth



Taylor Dissecting Forceps
ZI-03-383-17
7 1/4"
1:2 teeth



ZI-03-384-06
6"
1:2 teeth

ZI-03-384-08
6"
1:2 teeth

ZI-03-384-10
6"
1:2 teeth



ZI-03-386-17
7"
1:2 teeth

ZI-03-387-17
7"
1:2 teeth



ZI-03-388-17
7"
1:2 teeth



Forceps



ZI-03-392-18
7 1/4"
1:2 teeth



ZI-03-392-21
8 1/4"
1:2 teeth



ZI-03-392-25
9 1/2"
1:2 teeth



Potts-Smith Dissecting Forceps

Rees Dressing Forceps
ZI-03-394-20
8"
Dressing Forceps for coagulation



Adson Dissecting Forceps
ZI-03-400-12
5"



Mini-Adson Dissecting Forceps
ZI-03-402-12
4 3/4"
1:2 teeth



Mini-Adson Dissecting Forceps
ZI-03-403-12
4 3/4"
1:2 teeth





Forceps



ZI-03-404-12
4 3/4"



ZI-03-404-15
6"



ZI-03-406-12
4 3/4"
1:2 teeth



ZI-03-406-15
6"
1:2 teeth



Mikro-Adson Dressing Forceps



Dissecting Forceps
ZI-03-408-11
4"
1:2 teeth



Jeweler Type Forceps
ZI-03-409-12
4 3/4"
Fig. 7



Jeweler Type Forceps



ZI-03-410-12
4 3/4"
Fig. 3



ZI-03-412-11
4 3/4"
Fig. 3c



Forceps



Jeweler Type Forceps
ZI-03-414-11
4 1/4"
Fig. 5



Jeweler Type Forceps
ZI-03-416-11
4 1/4"
Fig. 4



Russ. Modell Dissecting Forceps



ZI-03-420-15
6"

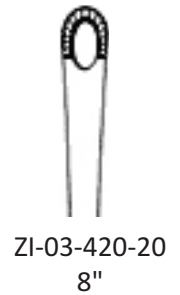

ZI-03-420-20
8"



ZI-03-420-25
10"



Forceps

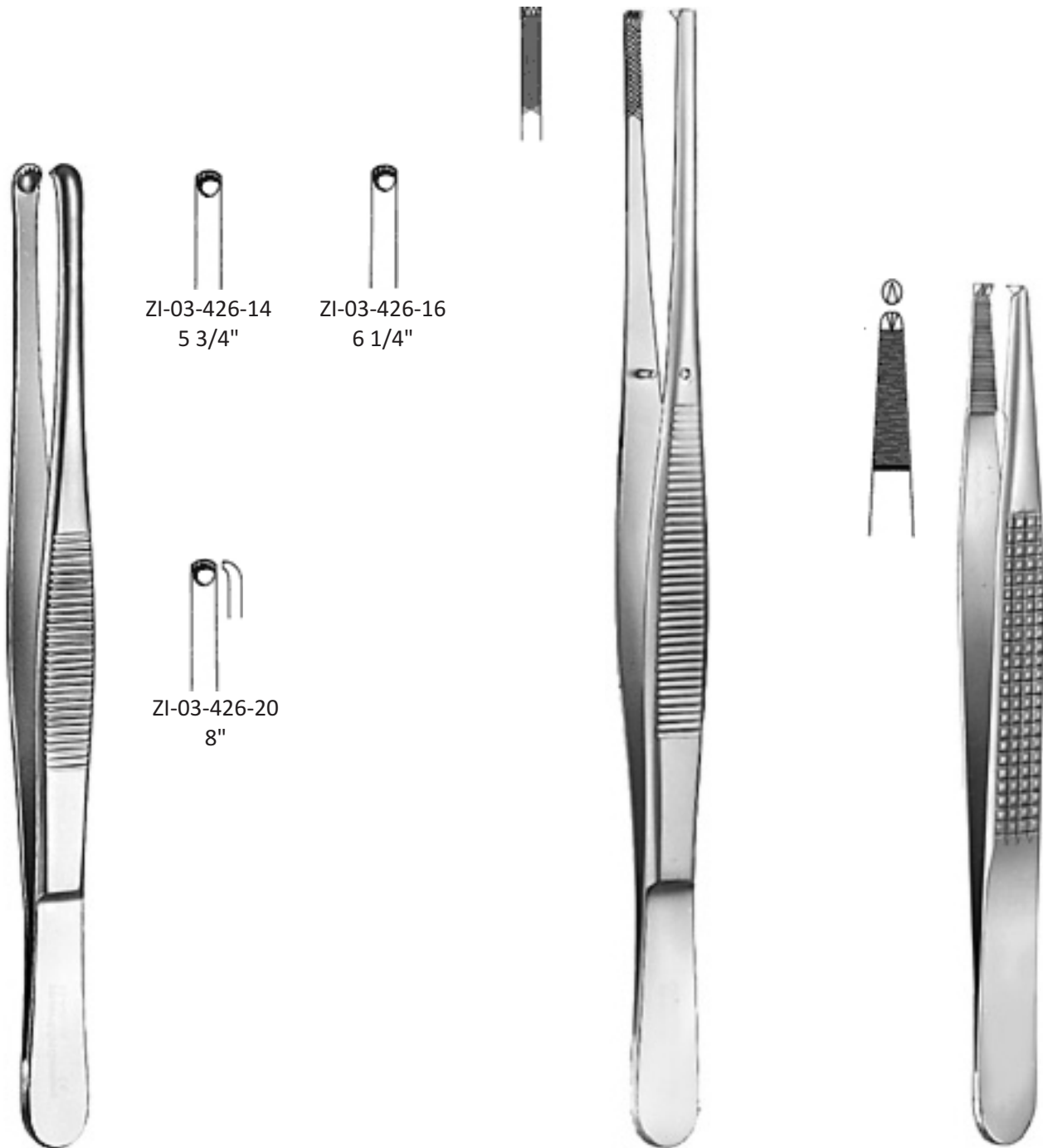

Durante Dissecting Forceps

ZI-03-426-14
5 3/4"

ZI-03-426-16
6 1/4"

ZI-03-426-20
8"

Stille-Barraya Dissecting Forceps

ZI-03-444-18
7"

Bonney Dissecting Forceps

ZI-03-451-18
7"
1:2 teeth



ZARYAB
INSTRUMENTS

Products that saves life

Forceps



Mayo Dissecting Forceps
ZI-03-456-23
9"



Singley-Tuttle Dissecting Forceps
ZI-03-460-18
7"



Singley-Tuttle Dissecting Forceps
ZI-03-460-23
9"



ZARYAB
I N S T R U M E N T S

Products that saves life

Forceps



Nelson Dissecting Forceps
ZI-03-466-23
9"



Hepp-Scheidel Tubal Forceps
ZI-03-468-18
7 1/4"



Forceps



Dressing Forceps
delicate



ZI-03-502-10
4"



ZI-03-503-10
4"



ZI-03-505-10
3 3/4"



ZI-03-512-10
4"
1:2 teeth



ZI-03-513-10
4"
1:2 teeth



ZI-03-515-10
3 3/4"
1:2 teeth



Forceps



ZI-03-564-15
6"
tips 6,0 x 0,4 mm



ZI-03-564-18
7"
tips 6,0 x 0,4 mm



ZI-03-565-15
6"
tips 6,0 x 0,4 mm



ZI-03-565-18
7"
tips 6,0 x 0,4 mm

Micro Dressing Forceps
diamond coated jaw

Micro Dressing Forceps
diamond coated jaw



ZI-03-566-15
6"



ZI-03-566-18
7"



ZI-03-566-21
8 1/4"



ZI-03-566-23
9"



ZI-03-567-15
6"



ZI-03-567-18
7"



ZI-03-567-21
6"



ZI-03-567-23
9"

Micro Dressing Forceps
diamond coated jaw
tips 6,0 x 0,7 mm



ZARYAB
I N S T R U M E N T S

Products that saves life

Forceps

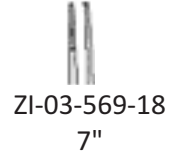
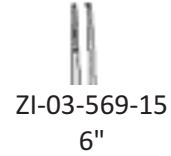

Micro Dissecting Forceps
diamond coated jaw
tips 6,0 x 0,4 mm

Micro Dissecting Forceps
diamond coated jaw
tips 6,0 x 0,4 mm



ZI-03-570-15
6"



ZI-03-570-18
7"



ZI-03-570-21
8 1/4"



ZI-03-570-23
9"



ZI-03-571-15
6"



ZI-03-571-18
7"



ZI-03-571-21
8 1/4"



ZI-03-571-23
9"

Micro Dissecting Forceps
diamond coated jaw
tips 6,0 x 0,7 mm



- ZI-03-574-15
6"
- ZI-03-574-18
7"
- ZI-03-574-21
8 1/4"
- ZI-03-574-23
9"



- ZI-03-576-15
6"
- ZI-03-576-18
7"
- ZI-03-576-21
8 1/4"
- ZI-03-576-23
9"

Micro Ring Forceps
diamond coated jaw
tips 1,0 x 0,5 mm

Micro Ring Forceps
tips 2,0 x 1,0 mm



ZARYAB
INSTRUMENTS

Products that saves life

Forceps

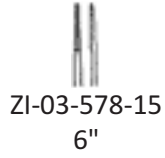

ZI-03-578-15
6"

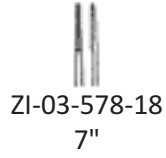

ZI-03-578-18
7"

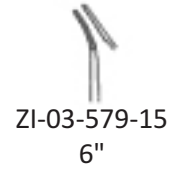

ZI-03-579-15
6"

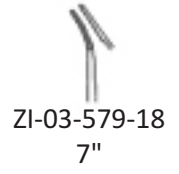

ZI-03-579-18
7"

Micro Dressing Forceps
tips 6,0 x 0,4 mm

Micro Dressing Forceps
tips 6,0 x 0,4 mm



ZI-03-580-15
6"



ZI-03-580-18
7"



ZI-03-580-21
8 1/4"



ZI-03-581-15
6"



ZI-03-581-15
6"



ZI-03-581-15
6"

Micro Dressing Forceps
tips 6,0 x 0,8 mm



Forceps

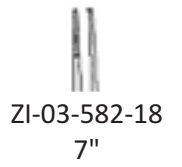
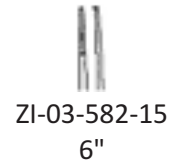
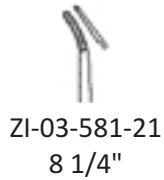
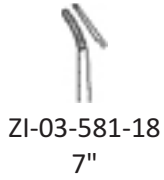

Micro Dressing Forceps
tips 6,0 x 0,8 mm

Micro Dressing Forceps
tips 6,0 x 0,4 mm



ZI-03-583-15
6"
tips 6,0 x 0,4 mm



ZI-03-583-18
7"
tips 6,0 x 0,4 mm



ZI-03-584-15
6"
tips 6,0 x 0,8 mm



ZI-03-584-18
7"
tips 6,0 x 0,8 mm



ZI-03-584-21
8 1/4"
tips 6,0 x 0,8 mm



ZI-03-585-15
6"
tips 6,0 x 0,8 mm



ZI-03-585-18
7"
tips 6,0 x 0,8 mm



ZI-03-585-21
8 1/4"
tips 6,0 x 0,8 mm



ZI-03-585-15
6"



ZI-03-585-18
7"



ZI-03-585-21
8 1/4"

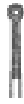

ZI-03-586-15
6"



ZI-03-586-18
7"



ZI-03-586-21
8 1/4"



ZI-03-588-15
6"



ZI-03-588-18
7"



ZI-03-588-21
8 1/4"

Micro Ring Forceps
diamond coated jaw
tips 1,0 x 0,5 mm



ZI-03-589-15
6"
tips 1,2 mm



ZI-03-589-18
7"
tips 1,2 mm



ZI-03-589-21
8 1/4"
tips 1,2 mm



ZI-03-590-15
6"
tips 1,2 mm



ZI-03-590-18
7"
tips 1,2 mm



ZI-03-590-21
8 1/4"
tips 1,2 mm





ZARYAB
INSTRUMENTS

Products that saves life

Forceps



Splinter Forceps
ZI-03-600-12
5"
smooth jaw



Splinter Forceps
ZI-03-601-12
5"
smooth jaw



ZARYAB
I N S T R U M E N T S

Products that saves life

Forceps



Splinter Forceps
ZI-03-604-12
5"
smooth jaw



Splinter Forceps
ZI-03-605-12
5"
smooth jaw



ZARYAB
I N S T R U M E N T S

Products that saves life

Forceps



Micro Tying Forceps
ZI-03-616-16
6"

Micro Tying Forcepssmooth jaw



Forceps



Splinter Forceps
Feilchenfeld



ZI-03-630-07
3 1/4"



ZI-03-630-09
3 1/2"



ZI-03-630-11
4 1/2"



ZI-03-640-10
4"



ZI-03-641-10
4"



Splinter Forceps
Hunter



ZARYAB
INSTRUMENTS

Products that saves life

Forceps



Microscopic Forceps
ZI-03-657-10
4"
super light, blunt



Microscopic Forceps
ZI-03-659-10
4"
super light, pointed



Splinter Forceps
ZI-03-661-09
3 3/4"



ZARYAB
I N S T R U M E N T S

Products that saves life

Forceps



Cilia Forceps
ZI-03-664-08
3 1/4"



Cilia Forceps
ZI-03-666-09
3 1/4"



Cilia Forceps
ZI-03-674-09
3 1/2"



Forceps



Cilia Forceps
ZI-03-676-09
3 1/2"



Cilia Forceps
ZI-03-680-09
3 1/2"



Cilia Forceps
ZI-03-695-10
4"



Forceps



ZI-03-720-13
5 1/2"



ZI-03-721-13
5 1/4"



Splinter Forceps
Peet
ZI-03-725-11
5"





ZARYAB
I N S T R U M E N T S

Products that saves life

Forceps



Splinter Forceps
ZI-03-740-15
6"



Splinter Forceps
ZI-03-741-15
6"



Forceps



Clip Applying Forceps
ZI-04-050-14
5 3/4"
without lock



Clip Applying Forceps
ZI-04-051-14
5 3/4"
with lock



Vessel Clip
ZI-04-052-04
jaw opening 4 mm
jaw length 6 mm
closing pressure 30 – 40 gr



Vessel Clip
ZI-04-052-04
jaw opening 5 mm
jaw length 9 mm
closing pressure 30 – 40 gr



Vessel Clip
ZI-04-052-04
jaw opening 5 mm
jaw length 9 mm
closing pressure 20 – 25 gr



Approximator
Biemer-Müller



ZI-04-054-05
jaw opening 5 mm
jaw length 9 mm
closing pressure 25 – 30 gr
straight



ZI-04-055-05
jaw opening 5 mm
jaw length 9 mm
closing pressure 25 – 30 gr
angled



ZI-04-056-03
jaw opening 3 mm
jaw length 4,5 mm
closing pressure 25 – 30 gr
straight



Approximator
Biemer-Müller



Approximator
Biemer-Müller



ZI-04-058-05
jaw opening 5 mm
jaw length 9 mm
closing pressure 25 – 30 gr
straight



ZI-04-059-05
jaw opening 5 mm
jaw length 9 mm
closing pressure 25 – 30 gr
angled



Approximator
Müller



ZI-04-060-01
diameter 1 mm closing
pressure 25 – 30 gr.



ZI-04-060-02
diameter 2 mm closing
pressure 25 – 30 gr.



Approximator
Müller



ZI-04-060-03
diameter 3 mm closing
pressure 25 – 30 gr.



ZI-04-060-03
diameter 4 mm closing
pressure 25 – 30 gr.



Approximator
ZI-04-062-00
complete with key for Micro vessel
anastomosis in the depth



Approximator
ZI-04-062-01
complete with key for Micro vessel
anastomosis in the depth



Approximator
ZI-04-062-02
complete with key for Micro vessel
anastomosis in the depth



Forceps



Nerve Approximator
ZI-04-063-00
complete with keyneedles
exchangeable by means of key

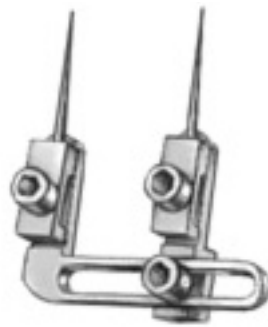

Nerve Approximator
ZI-04-063-02
complete with keyneedles
exchangeable by means of key

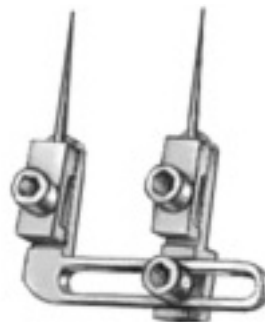

Spare Needle
ZI-04-063-04
onlypair



Forceps

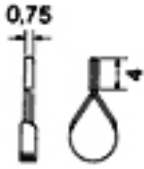

Mini Vessel Clip
ZI-04-102-04
jaw 4,0 x 0,75
mmclosing pressure 60 gr.



Mini Vessel Clip
ZI-04-102-08
jaw 8,0 x 2,0
mmclosing pressure 100 gr.



Mini Vessel Clip
ZI-04-102-10
jaw 10,0 x 2,0
mmclosing pressure 125 gr.

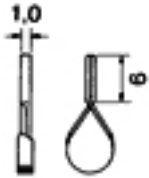

Mini Vessel Clip
ZI-04-102-06
jaw 6,0 x 1,0
mmclosing pressure 85 gr.

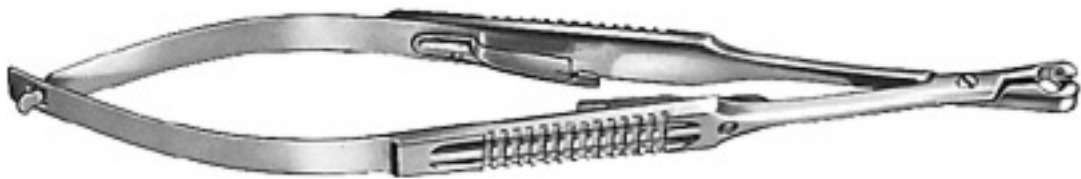

Clip Applying Forceps
ZI-04-104-14
5 3/4"
with ratchet



Clip Applying Forceps
ZI-04-106-18
7 1/4"
with ratchet



Forceps



Bulldog Clamp
jaw length 10 mm
closing pressure 30 gr.
weight 1 gr.



ZI-04-108-10
31



ZI-04-108-14
35



ZI-04-108-18
39



ZI-04-109-10
30



ZI-04-109-14
33



ZI-04-109-18
36



Bulldog Clamp
Dieffenbach



ZI-04-110-06
2 1/4"



ZI-04-111-06
2 1/4"



ZI-04-114-03
1 1/2"



ZI-04-114-05
2"



ZI-04-115-03
1 1/2"



ZI-04-115-05
2"



Bulldog Clamp
Johns-Hopkins



ZI-04-119-05
2"



ZI-04-119-06
2 1/4"



ZI-04-119-07
2 3/4"



Forceps



Bulldog Clamp



Diethrich
ZI-04-120-08
3.5
jaw length 8 mm
closingpressure 50
gr.weight 3 gr.



Diethrich
ZI-04-120-10
4.55
jaw length 12 mm
closingpressure 50
gr.weight 3 gr.



Diethrich
ZI-04-120-12
5
jaw length 20 mm
closingpressure 50
gr.weight 3 gr.



Diethrich
ZI-04-121-08
4.5
jaw length 8 mm
closingpressure 50
gr.weight 3 gr.



Diethrich
ZI-04-121-10
5
jaw length 12 mm
closingpressure 50
gr.weight 3 gr.



Diethrich
ZI-04-121-12
6
jaw length 20 mm
closingpressure 50
gr.weight 3 gr.



DeBakey-Diethrich
ZI-04-122-10
4.5
jaw length 10 mm
closingpressure 180
gr.weight 3 gr.



DeBakey-Diethrich
ZI-04-122-14
5
jaw length 10 mm
closingpressure 180
gr.weight 3 gr.



DeBakey-Diethrich
ZI-04-122-20
6
jaw length 10 mm
closingpressure 180
gr.weight 3 gr.



DeBakey-Diethrich
ZI-04-123-10
3.5
jaw length 10 mm
closingpressure 180
gr.weight 3 gr.



DeBakey-Diethrich
ZI-04-123-14
4.5
jaw length 10 mm
closingpressure 180
gr.weight 3 gr.



DeBakey-Diethrich
ZI-04-123-20
6
jaw length 10 mm
closingpressure 180
gr.weight 3 gr.



Forceps



Bulldog Clamp
ZI-04-132-30
30

jaw length 9 mm

closing pressure 110 +/- 10 gr.weight 1 gr.



Bulldog Clamp
ZI-04-132-35
35

jaw length 13 mm

closing pressure 110 +/- 10 grweight 1 gr



Bulldog Clamp
ZI-04-132-40
40

jaw length 14 mm

closing pressure 110 +/- 10 gr.weight 1 gr.



Bulldog Clamp
ZI-04-132-50
50

jaw length 23 mm

closing pressure 110 +/- 10 gr.weight 1,5 gr.



Forceps



Bulldog Clamp
ZI-04-135-30
30
jaw length 10 mm
closing pressure 110 +/- 10 gr.
weight 1 gr.



Bulldog Clamp
ZI-04-135-35
35
jaw length 14 mm
closing pressure 110 +/- 10 gr.
weight 1 gr.



Bulldog Clamp
ZI-04-135-40
40
jaw length 15 mm
closing pressure 110 +/- 10 gr.
weight 1 gr.



Bulldog Clamp
ZI-04-135-50
50
jaw length 21 mm
closing pressure 110 +/- 10 gr.
weight 1,5 gr.



Forceps



Bulldog Clamp
ZI-04-142-30
30
jaw length 9 mm
closing pressure 220 +/-
10 gr.weight 1 gr.



Bulldog Clamp
ZI-04-142-35
35
jaw length 13 mm
closing pressure 220 +/-
10 gr.weight 1 gr.



Bulldog Clamp
ZI-04-142-40
40
jaw length 14 mm
closing pressure 220 +/-
10 gr.weight 1 gr.



Bulldog Clamp
ZI-04-142-50
50
jaw length 23 mm
closing pressure 220 +/-
10 gr.weight 1,5 gr.



Forceps



Bulldog Clamp
ZI-04-143-30
30
jaw length 9 mm
closing pressure 220 +/-
10 gr.weight 1 gr.



Bulldog Clamp
ZI-04-143-35
35
jaw length 13 mm
closing pressure 220 +/-
10 gr.weight 1 gr.



Bulldog Clamp
ZI-04-143-40
40
jaw length 14 mm
closing pressure 220 +/-
10 gr.weight 1 gr.



Bulldog Clamp
ZI-04-143-50
50
jaw length 22 mm
closing pressure 220 +/-
10 gr.weight 1,5 gr.



Forceps



Bulldog Clamp
ZI-04-145-30
30
jaw length 10 mm
closing pressure 220 +/-
10 gr.weight 1 gr.



Bulldog Clamp
ZI-04-145-35
35
jaw length 14 mm
closing pressure 220 +/-
10 gr.weight 1 gr.



Bulldog Clamp
ZI-04-145-40
40
jaw length 15 mm
closing pressure 220 +/-
10 gr.weight 1 gr.



Bulldog Clamp
ZI-04-145-50
50
jaw length 21 mm
closing pressure 220 +/-
10 gr.weight 1,5 gr.



ZARYAB
I N S T R U M E N T S

Products that saves life

Forceps



Haemostatic Forceps
Pean



ZI-04-176-14
5 3/4"



ZI-04-176-16
6 1/4"



Forceps



ZI-04-248-13
5"



ZI-04-248-14
5 1/2"



ZI-04-248-15
6"



ZI-04-248-18
7 1/4"



ZI-04-248-20
8"

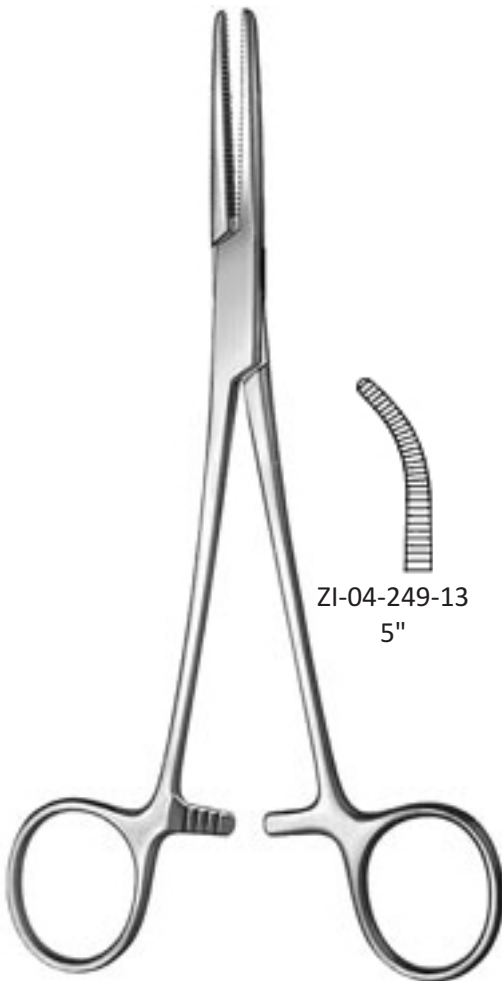

ZI-04-249-13
5"



ZI-04-249-14
5 1/2"



ZI-04-249-15
6"



ZI-04-249-18
7"



ZI-04-249-20
8"

Haemostatic Forceps
Spencer-Wells



Haemostatic Forceps
Chaput
ZI-04-256-13
5"
2:3 teeth



Haemostatic Forceps
Tuffier
ZI-04-258-13
5"
4:5 teeth



Organ Grasping Forceps



ZI-04-266-25
9 3/4"



ZI-04-266-26
10 1/4"



ZI-04-268-14
5 1/2"

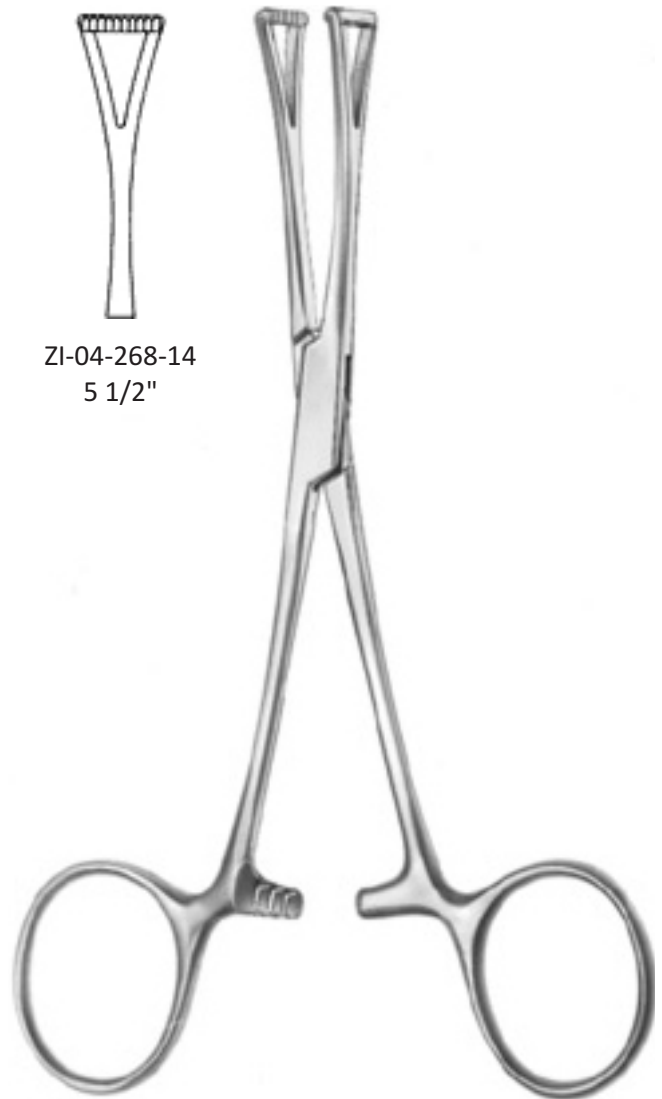

Organ Grasping Forceps
Collin



ZI-04-280-15
6"



ZI-04-280-20
8 1/4"



Haemostatic Forceps
Pennington



Tumor Grasping Forceps
Collin
ZI-04-278-17
6 3/4"



Haemostatic Forceps
Pratt
ZI-04-282-15
6"

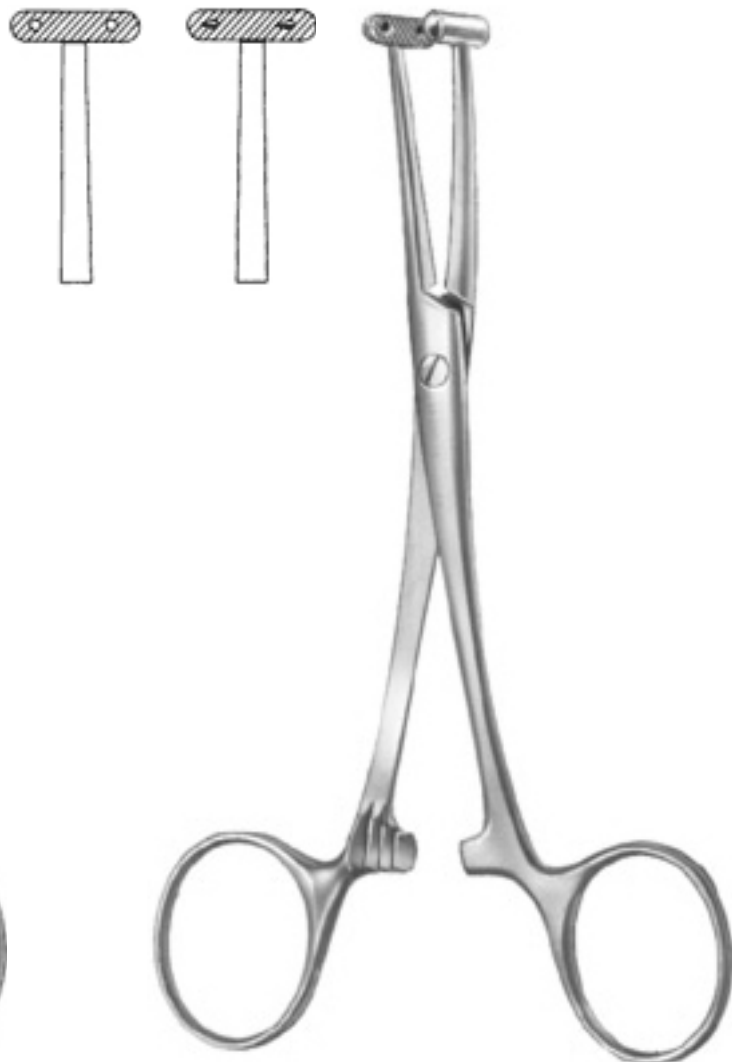

Face-lift Forceps
Martel-Rees
ZI-04-290-14
5 1/4"



ZARYAB
INSTRUMENTS

Products that saves life

Forceps



Ligature Forceps
ZI-04-302-12
5"



ZI-13-303-01
5 1/4"



ZI-13-303-02
5"



Dissecting and Ligature Forceps
Mixer-Baby



ZI-13-306-10
4"



ZI-13-307-10
3 3/4"

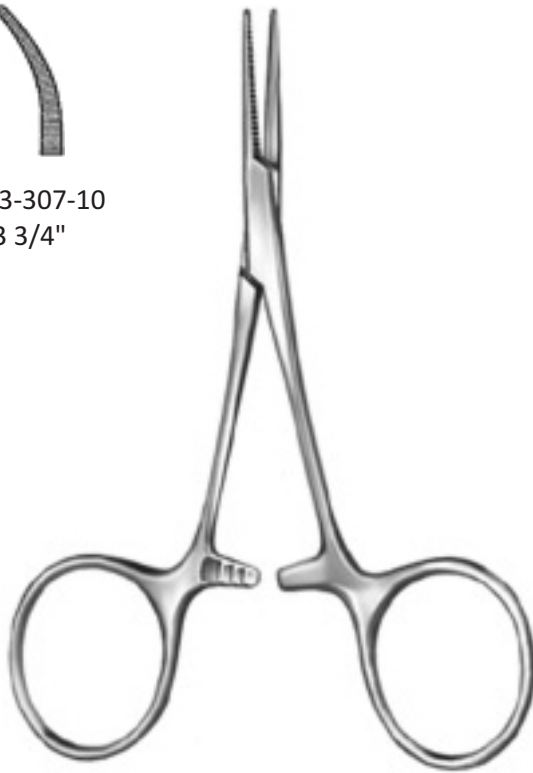

Haemostatic Forceps
Hartmann



Ligature Forceps
ZI-04-309-12
5"
cross serrated jaw



Forceps



ZI-04-310-12
5"



ZI-04-310-14
5 3/4"



ZI-04-310-62
5"



ZI-04-311-12
4 3/4"



ZI-04-311-14
5 1/2"



ZI-04-311-62
4 3/4"



ZI-04-312-12
5"
1:2 teeth



ZI-04-312-14
5 3/4"
1:2 teeth



ZI-04-312-62
4 3/4"
1:2 teeth



ZI-04-313-12
4 3/4"
1:2 teeth



ZI-04-313-14
5 1/2"
1:2 teeth



ZI-04-313-62
4 3/4"
1:2 teeth





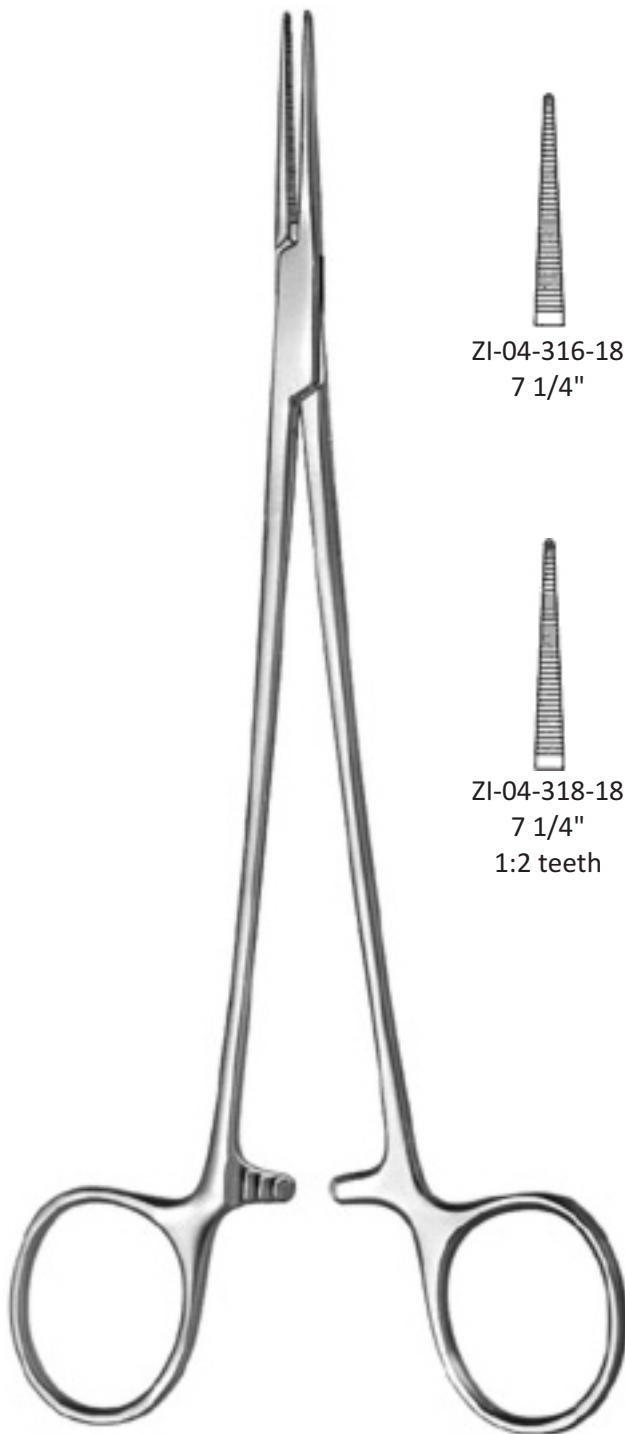





Haemostatic Forceps
Halsted-Mosquito



ZI-04-316-18 7 1/4"	ZI-04-316-21 8 1/4"	ZI-04-317-18 7"	ZI-04-317-21 8"
ZI-04-318-18 7 1/4" 1:2 teeth	ZI-04-318-21 8 1/4" 1:2 teeth	ZI-04-319-18 7" 1:2 teeth	ZI-04-319-21 8" 1:2 teeth

Haemostatic Forceps
Halsted-Mosquito



			
ZI-04-320-10 4"	ZI-04-320-12 4 3/4"	ZI-04-321-10 3 3/4"	ZI-04-321-12 4 1/2"
			
ZI-04-322-10 4" 1:2 teeth	ZI-04-322-12 4 3/4" 1:2 teeth	ZI-04-323-10 4" 1:2 teeth	ZI-04-323-12 4 3/4" 1:2 teeth

Haemostatic Forceps
Mikro-Mosquito



Haemostatic Forceps



Providence-Hospital
ZI-13-324-14
5 1/2"



Providence-Hospital
ZI-13-325-14
5 1/2"



Leriche
ZI-04-326-15
6"



Leriche
ZI-04-327-15
6"



Leriche
ZI-04-328-15
6"



Leriche
ZI-04-329-15
6"



Forceps



Haemostatic Forceps
Kelly



ZI-04-330-14
5 3/4"



ZI-04-330-64
5 3/4"



ZI-04-331-14
5 1/2"



ZI-04-331-64
5 1/2"



Kelly-Rankin
ZI-04-334-16
6 1/4"



Kelly-Rankin
ZI-04-335-16
6"



ZARYAB
I N S T R U M E N T S

Products that saves life

Forceps



Dissecting and Ligature Forceps
Overholt-Baby
ZI-04-339-14
5 1/2"



Forceps



Haemostatic Forceps
Crile



ZI-04-340-14
5 3/4"



ZI-04-340-64
5 3/4"



ZI-04-341-14
5 1/2"



ZI-04-341-64
5 1/2"



ZI-04-342-14
5 3/4"
teeth



ZI-04-343-14
5 1/2"
teeth



ZARYAB
I N S T R U M E N T S

Products that saves life

Forceps



ZI-04-346-16
6 1/2"



ZI-04-347-16
6 1/4"



Haemostatic Forceps
Crile-Rankin



ZARYAB
I N S T R U M E N T S

Products that saves life

Forceps



ZI-04-348-15
6 1/4"



ZI-04-350-15
6 1/4"
1:2 teeth

Haemostatic Forceps
Lovelace



Forceps

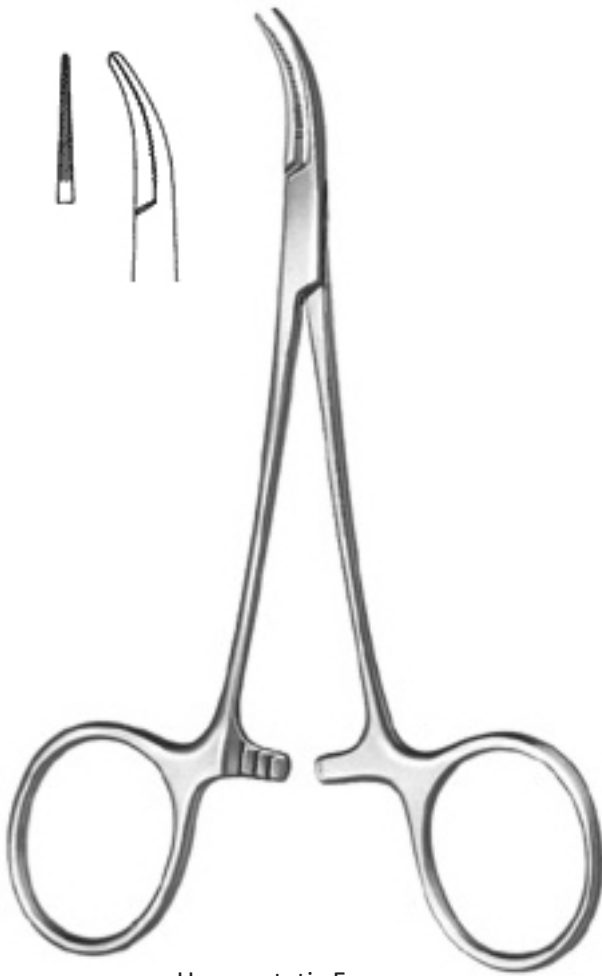

Haemostatic Forceps
Dandy-Mosquito
ZI-04-351-12
4 3/4"
laterally curved



Haemostatic Forceps
Dandy

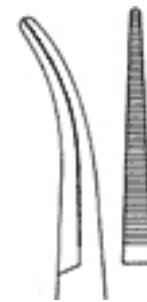

ZI-04-355-14
5 3/4"
laterally curved

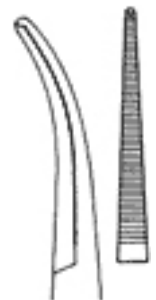

ZI-04-357-14
5 1/2"
laterally curved 1:2 teeth



Forceps



ZI-04-363-18
7 1/4"



ZI-04-363-19
7 1/2"



ZI-04-364-18
7 1/2"



ZI-04-365-18
7 1/4"

Dissecting and Ligature Forceps
Schmidt

Dissecting and Ligature Forceps
Adson



Forceps



Dissecting and Ligature Forceps
Martin-Fuchsig
HIM-04-369-20
8"

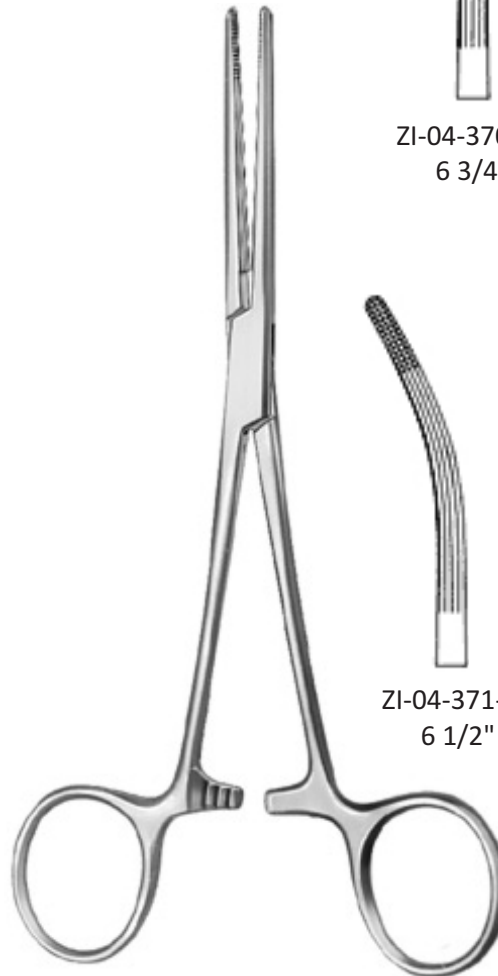

Haemostatic Forceps
Rochester-Carmalt



ZI-04-370-16
6 3/4"



ZI-04-370-20
8"



ZI-04-371-16
6 1/2"



ZI-04-371-20
8"



Forceps

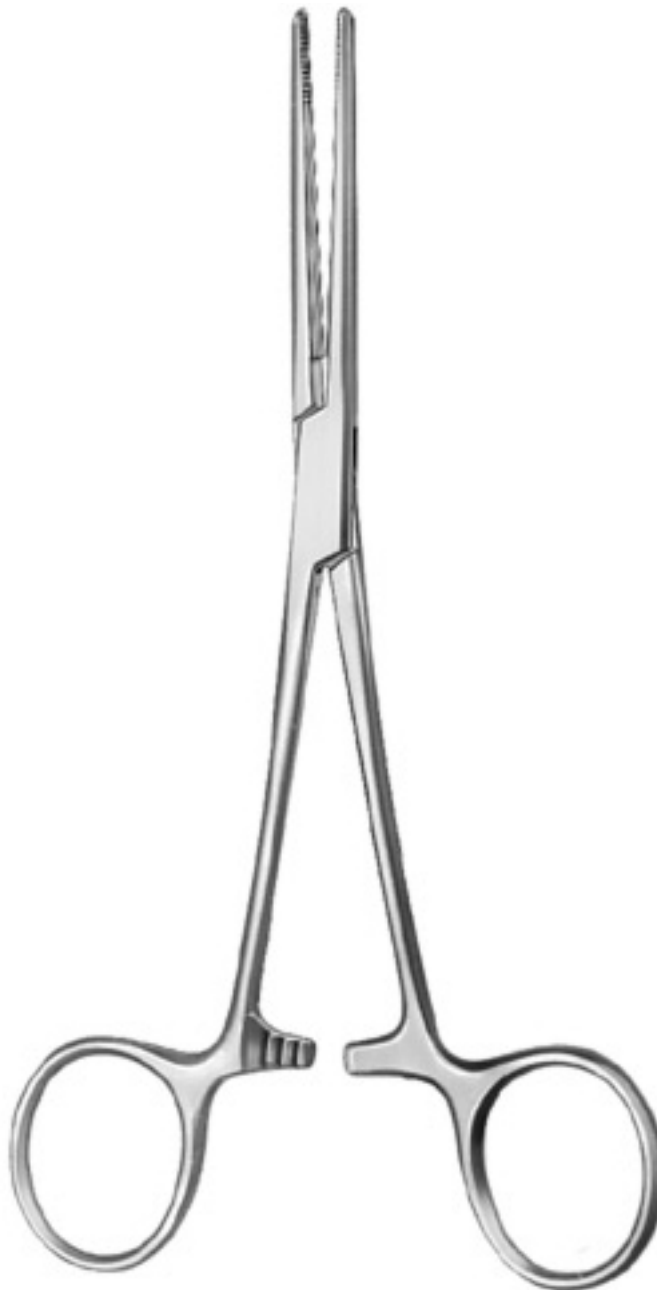

Haemostatic Forceps
Rochester-Carmalt



ZI-04-370-16
6 3/4"



ZI-04-370-20
8"



ZI-04-371-16
6 1/2"



ZI-04-371-20
8"



Forceps



Haemostatic Forceps
Pean



ZI-04-374-13
5 1/4"



ZI-04-374-14
5 3/4"



ZI-04-374-16
6 3/4"



ZI-04-375-13
5"



ZI-04-375-14
5 1/2"



ZI-04-375-16
6 1/2"

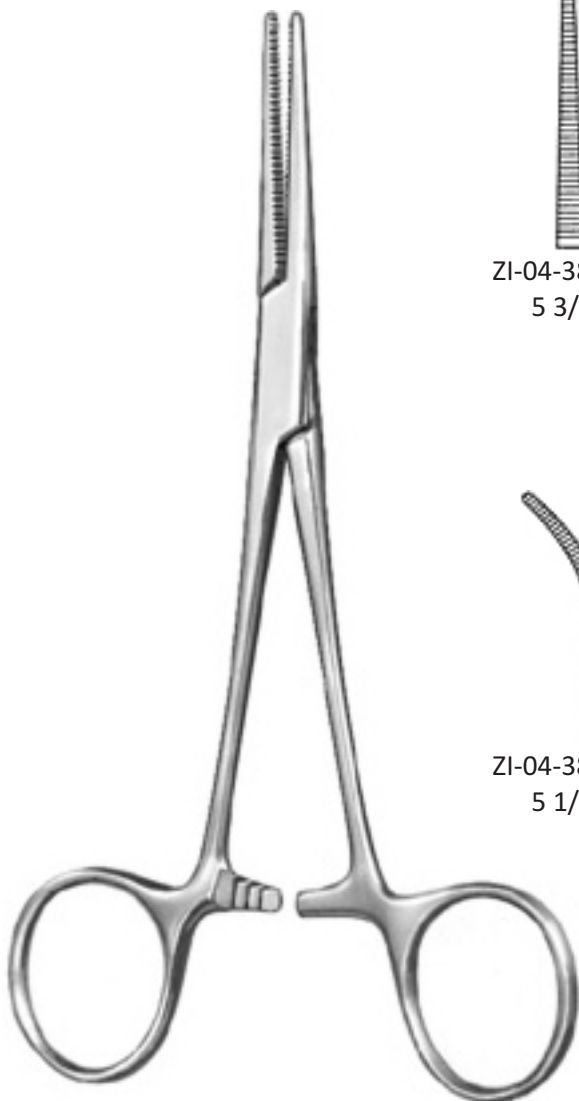

ZI-04-380-14
5 3/4"



ZI-04-380-16
6 1/2"



ZI-04-380-18
7 1/4"

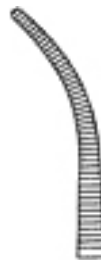

ZI-04-381-14
5 1/2"



ZI-04-381-16
6 1/4"



ZI-04-381-18
7"

Haemostatic Forceps
Pean-Nippon



Haemostatic Forceps
Kocher-Nippon



ZI-04-382-14
5 3/4"
1:2 teeth



ZI-04-382-16
6 1/2"
1:2 teeth



ZI-04-382-18
7 1/4"
1:2 teeth



ZI-04-383-14
5 1/2"
1:2 teeth



ZI-04-383-16
6 1/4"
1:2 teeth



ZI-04-383-18
7"
1:2 teeth



Forceps



Haemostatic Forceps
Kocher



ZI-04-384-13
5"
1:2 teeth



ZI-04-384-14
5 1/2"
1:2 teeth



ZI-04-384-16
6 1/4"
1:2 teeth



ZI-04-385-13
5"
1:2 teeth



ZI-04-385-14
5 1/2"
1:2 teeth



ZI-04-385-16
6 1/4"
1:2 teeth



Forceps



Haemostatic Forceps
Bengolea



ZI-04-390-20
8 1/2"



ZI-04-390-26
10 1/4"



ZI-04-391-20
8 1/4"



ZI-04-391-26
10"



ZI-04-392-20
8 1/2"
1:2 teeth



ZI-04-392-26
10 1/4"
1:2 teeth



ZI-04-393-20
8 1/4"
1:2 teeth



ZI-04-393-26
10"
1:2 teeth



Forceps



ZI-04-410-14
5 3/4"



ZI-04-410-16
6 1/2"



ZI-04-410-18
7 1/4"



ZI-04-410-20
8"



Haemostatic Forceps
Pean (Rochester)



ZI-04-410-22
8 3/4"



ZI-04-410-24
9 3/4"



ZI-04-410-26
10 1/4"



ZI-04-410-30
12"



Haemostatic Forceps
Pean (Rochester)

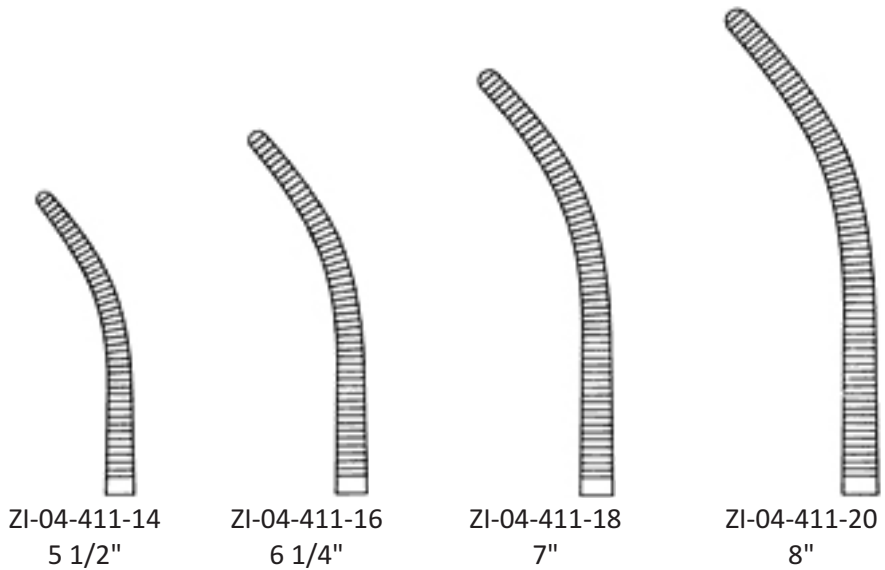



Forceps

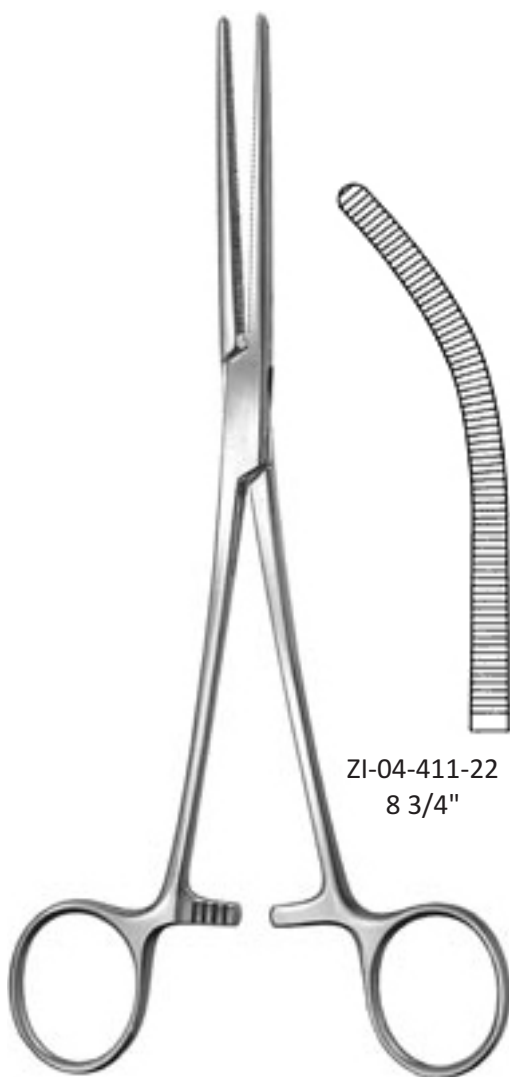

Haemostatic Forceps
Pean (Rochester)

ZI-04-411-22
8 3/4"

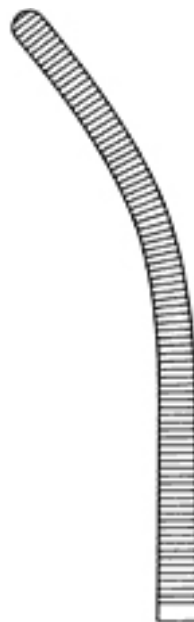

ZI-04-411-24
9 1/2"

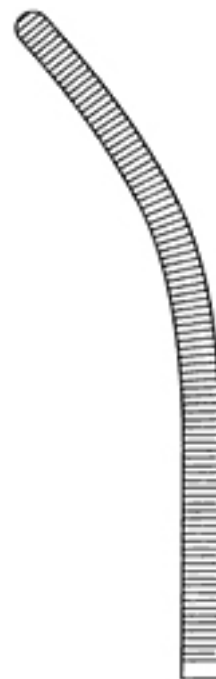

ZI-04-411-26
10"

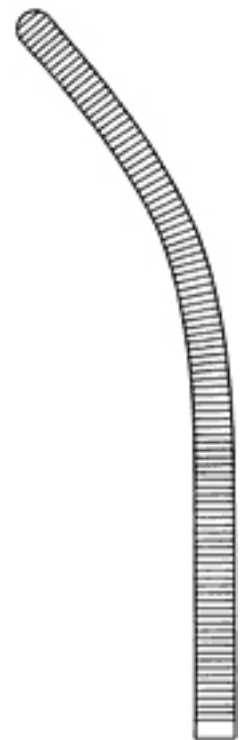

ZI-04-411-30
11 3/4"

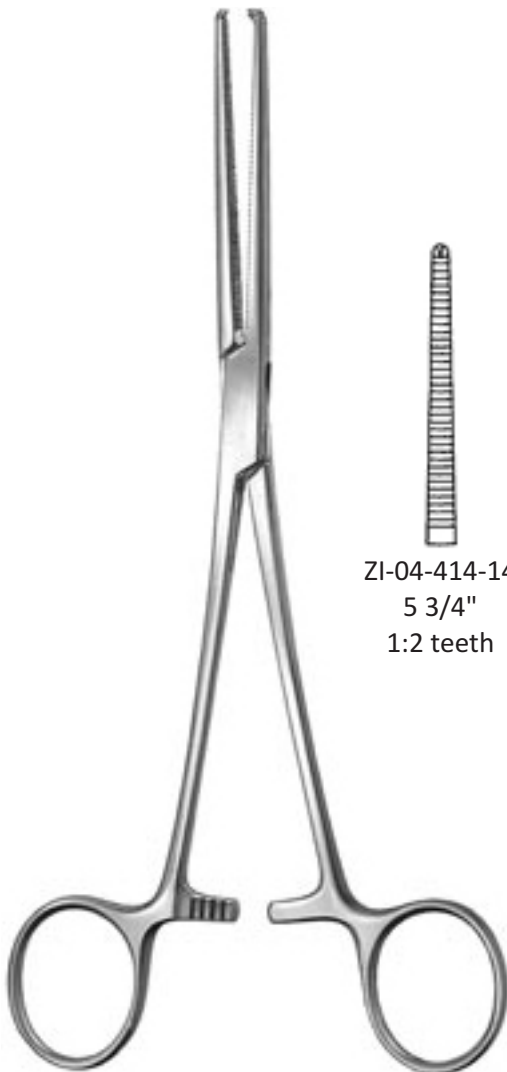

ZI-04-414-14
5 3/4"
1:2 teeth

ZI-04-414-16
6 1/2"
1:2 teeth

ZI-04-414-18
7 1/4"
1:2 teeth

ZI-04-414-20
8"
1:2 teeth

Haemostatic Forceps
Kocher (Ochsner)



ZARYAB
I N S T R U M E N T S

Products that saves life

Forceps

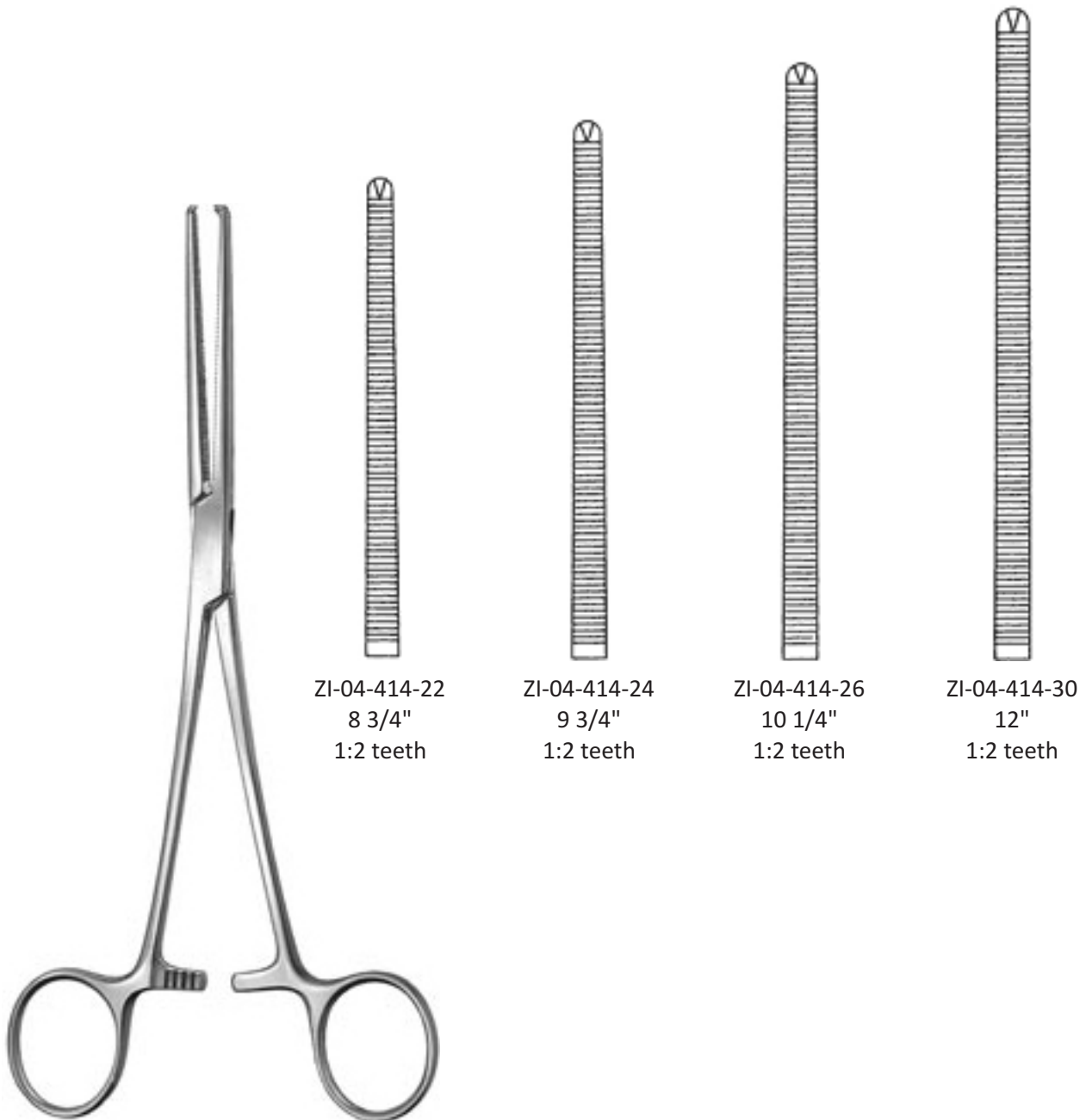

ZI-04-414-22
8 3/4"
1:2 teeth

ZI-04-414-24
9 3/4"
1:2 teeth

ZI-04-414-26
10 1/4"
1:2 teeth

ZI-04-414-30
12"
1:2 teeth

Haemostatic Forceps
Kocher (Ochsner)



Forceps

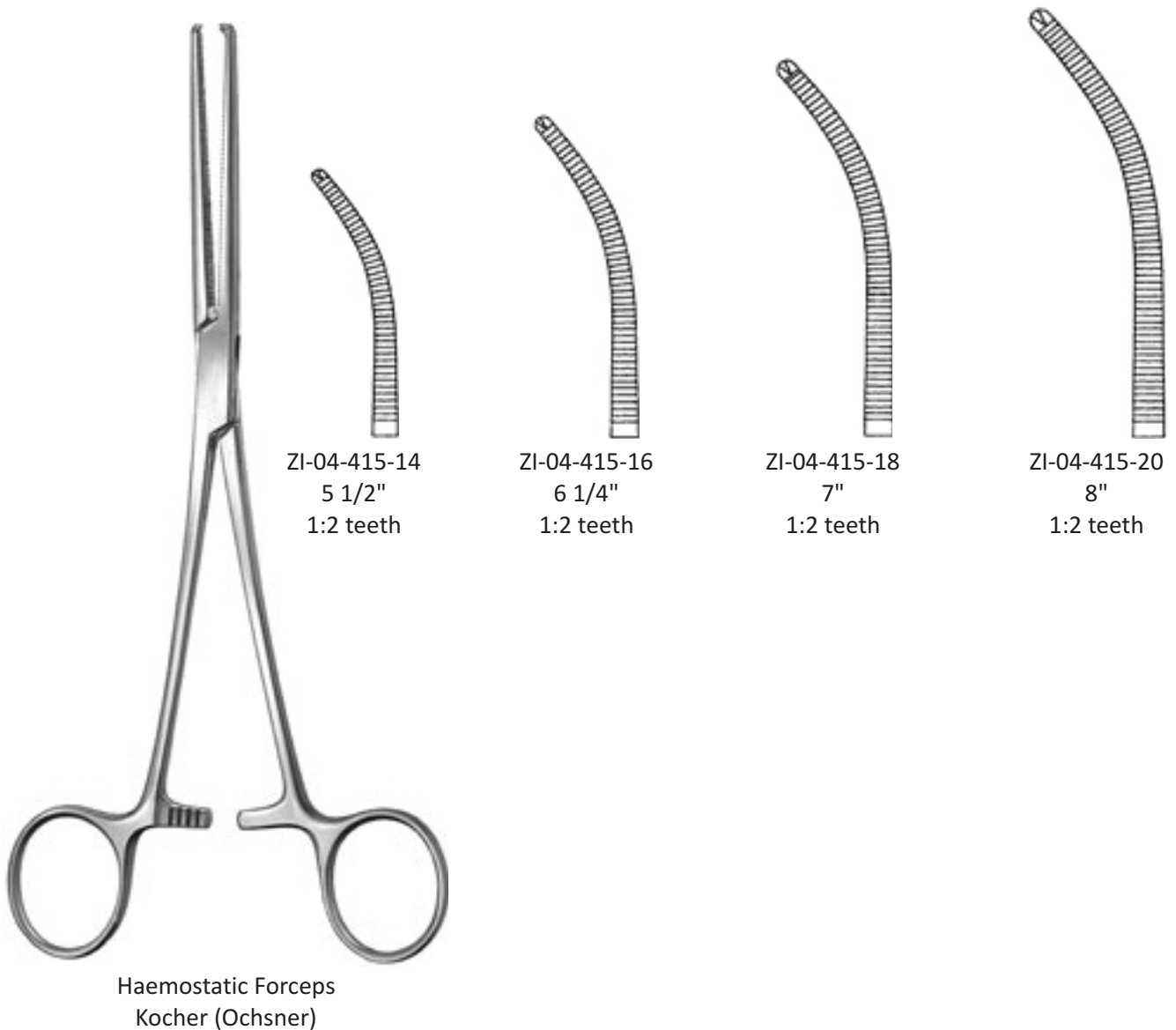



ZARYAB
INSTRUMENTS

Products that saves life

Forceps



Haemostatic Forceps
Kocher (Ochsner)

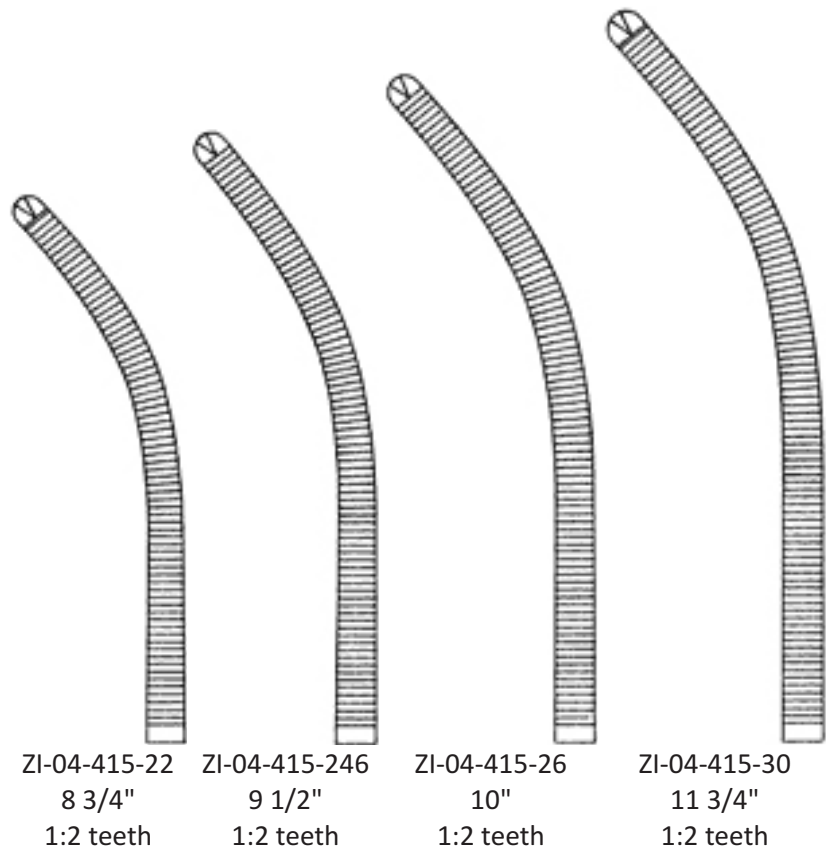

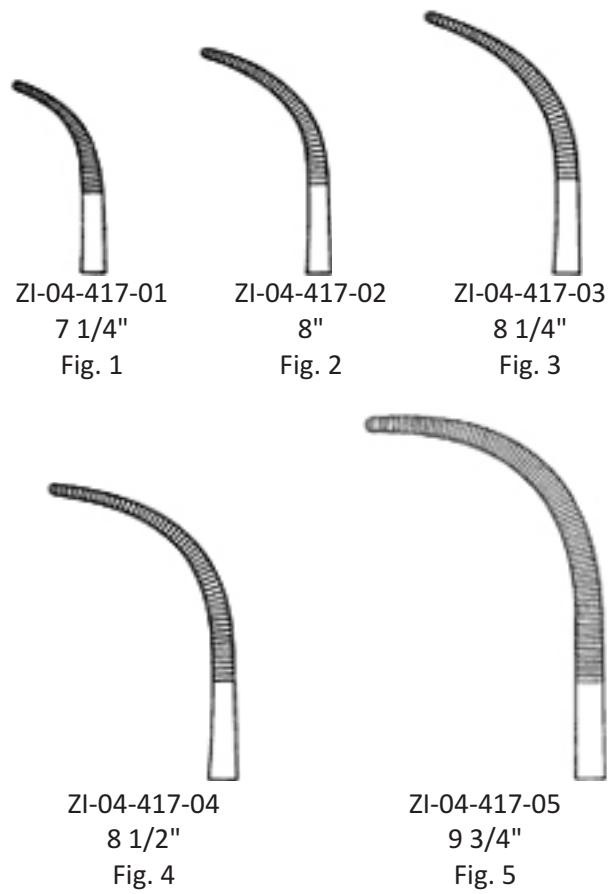
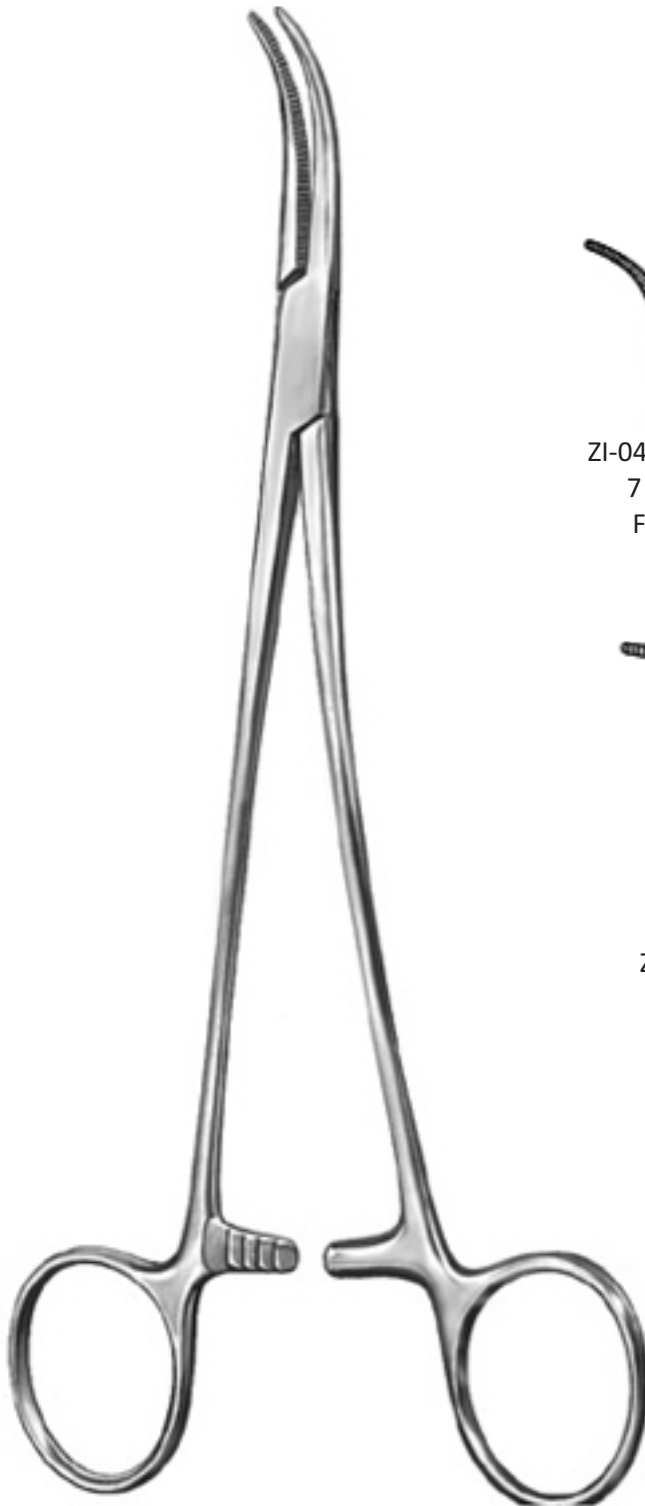

Dissecting and Ligature Forceps
Overholt-Martin



Forceps



Dissecting and Ligature Forceps
Mixer-Baby
ZI-04-419-18
7 1/4"

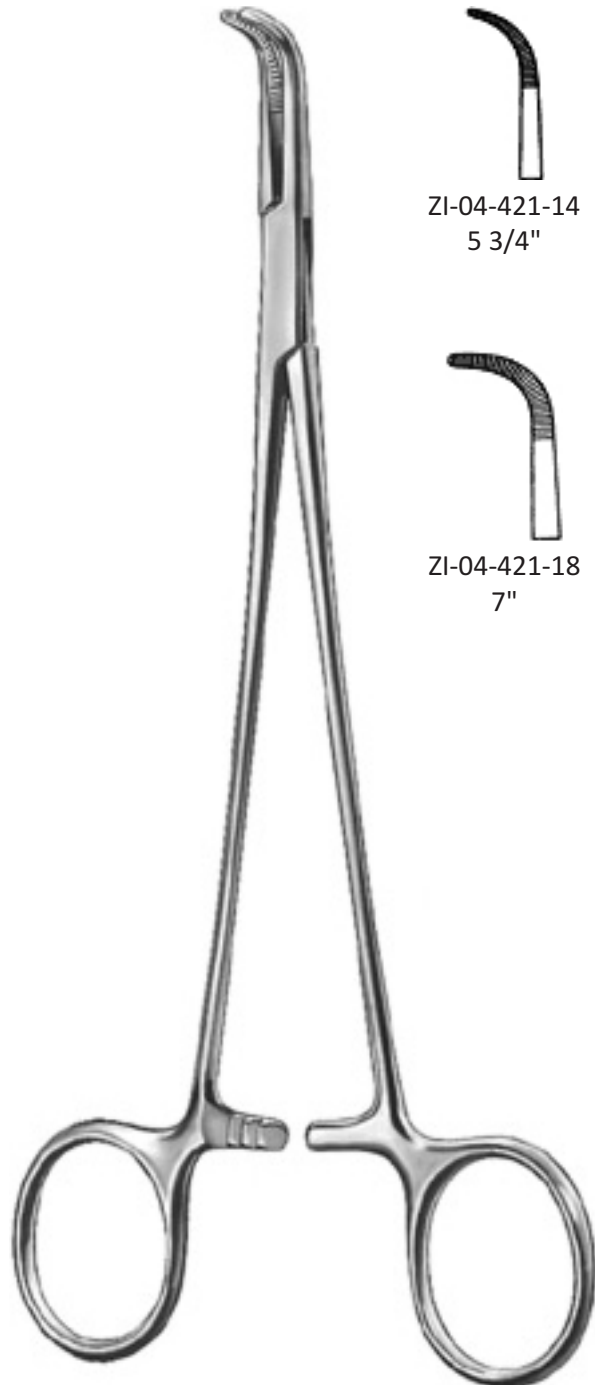

Dissecting and Ligature Forceps
Adson-Baby

ZI-04-421-14
5 3/4"

ZI-04-421-18
7"



ZARYAB
I N S T R U M E N T S

Products that saves life

Forceps



ZI-04-422-20
8 1/4"



ZI-04-423-20
8"



ZI-04-425-20
8"



Dissecting and Ligature Forceps
Heiss



Forceps



ZI-04-427-21
8 1/2"

Dissecting and Ligature Forceps
Overholt-Mixer



ZI-04-428-22
8 3/4"

Dissecting and Ligature Forceps
Roberts



ZI-04-429-22
8 1/2"

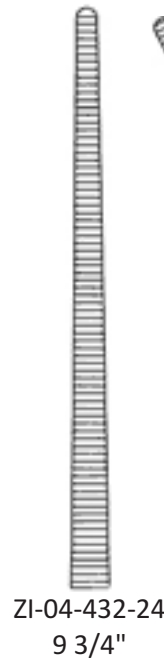

ZI-04-432-24
9 3/4"

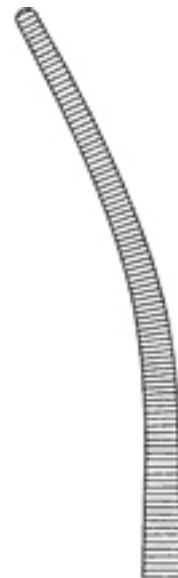

ZI-04-433-24
9 3/4"

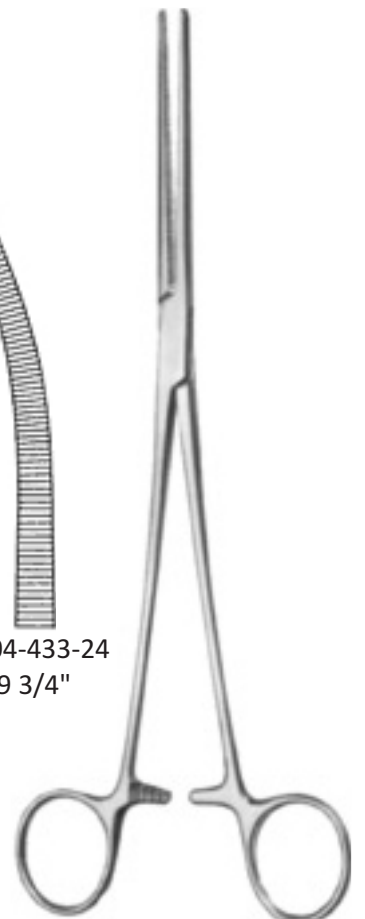

Dissecting and Ligature Forceps
Sarot



ZARYAB
I N S T R U M E N T S

Products that saves life

Forceps



ZI-04-439-18
7"



ZI-04-439-24
9 3/4"



Dissecting and Ligature Forceps
Crafoord

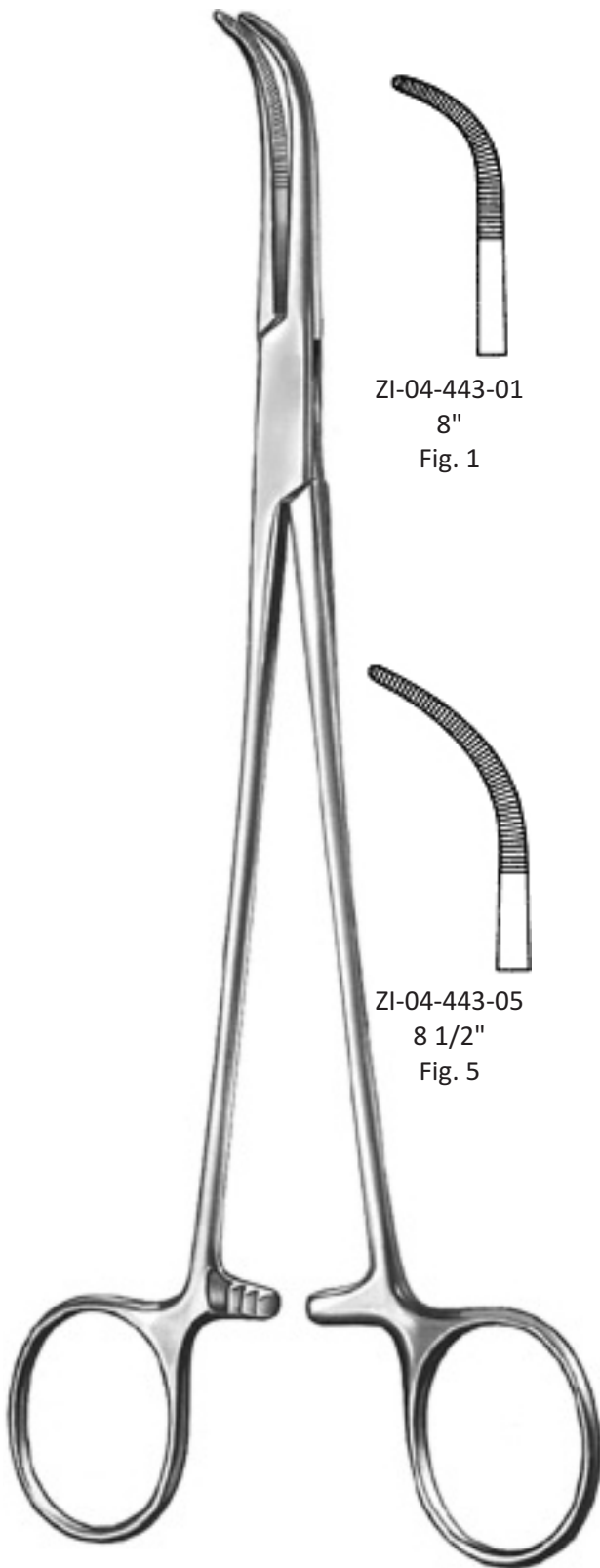

ZI-04-443-01
8"
Fig. 1

ZI-04-443-02
8"
Fig. 2

ZI-04-443-03
8 1/2"
Fig. 3

ZI-04-443-04
8 3/4"
Fig. 4

ZI-04-443-05
8 1/2"
Fig. 5

ZI-04-443-06
8 3/4"
Fig. 6

ZI-04-443-07
8 3/4"
Fig. 7

ZI-04-447-01
10 3/4"
Fig. 1

Dissecting and Ligature Forceps
Overholt-Geissendörfer



Forceps

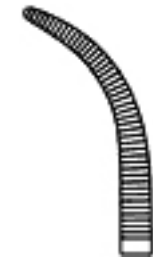
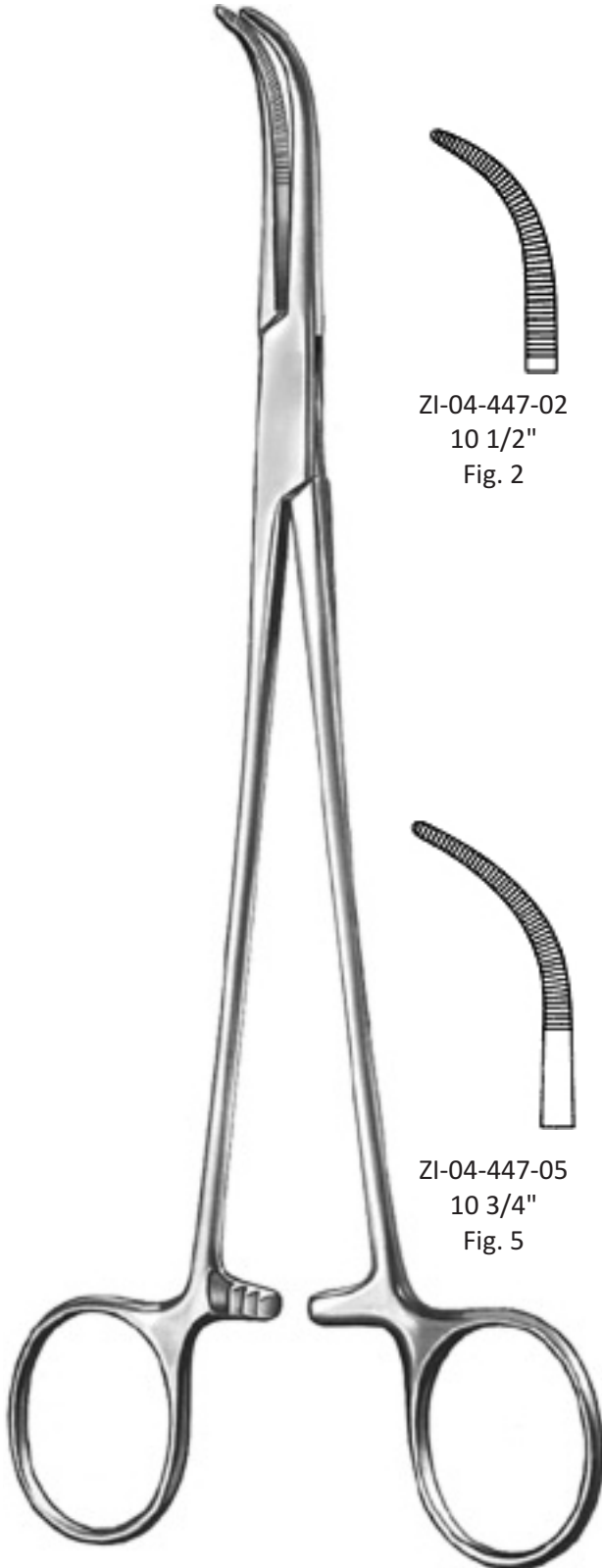

ZI-04-447-02
10 1/2"
Fig. 2



ZI-04-447-03
10 3/4"
Fig. 3



ZI-04-447-04
11"
Fig. 4

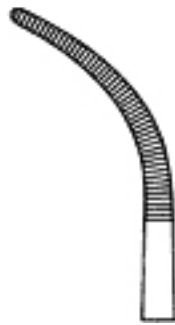

ZI-04-447-05
10 3/4"
Fig. 5



ZI-04-447-06
11"
Fig. 6



ZI-04-447-07
10 3/4"
Fig. 7

Dissecting and Ligature Forceps
Overholt-Geissendörfer



Forceps

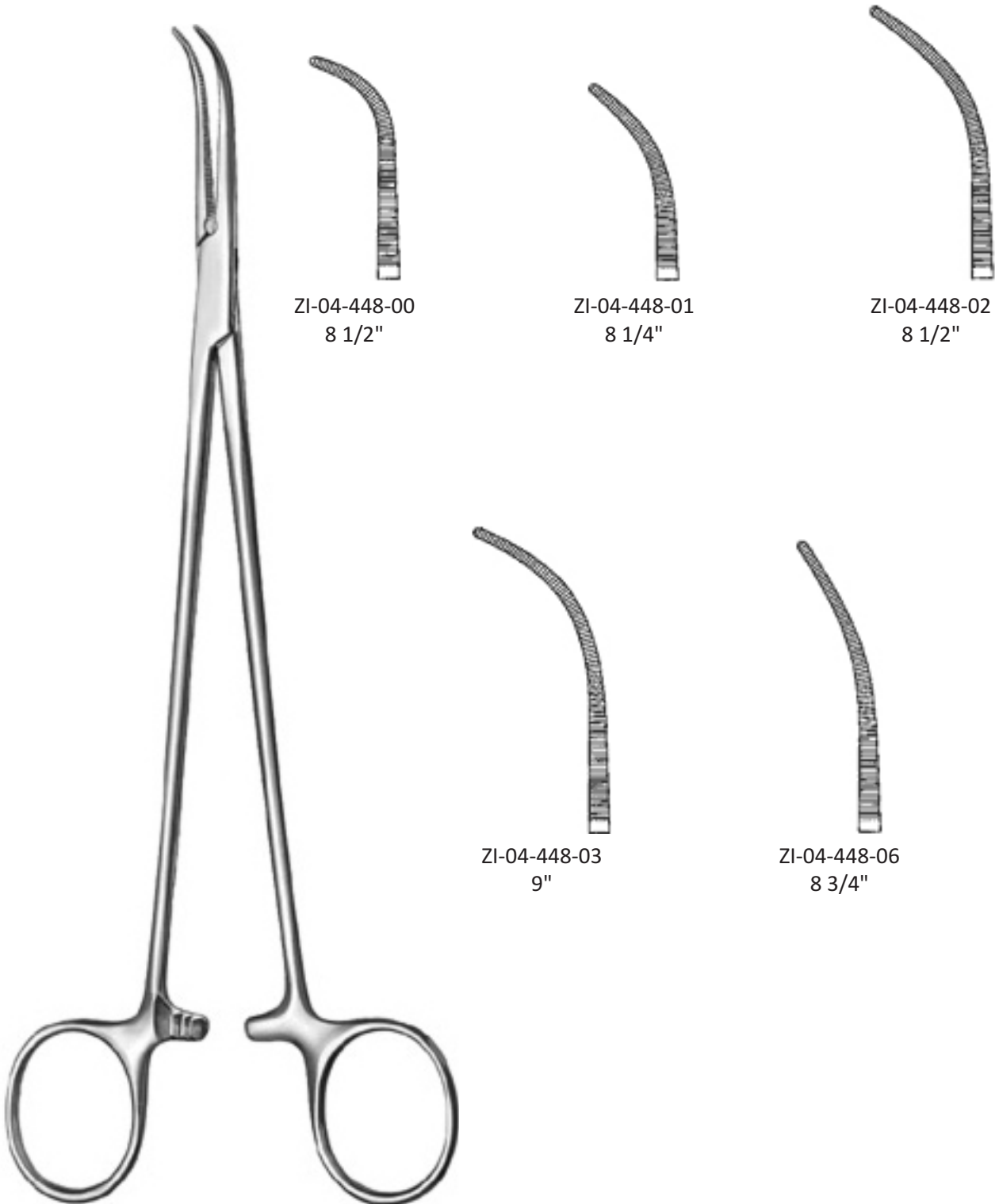

Dissecting and Ligature Forceps
Overholt-Fino



ZARYAB
I N S T R U M E N T S

Products that saves life

Forceps



Dissecting and Ligature Forceps
Overholt

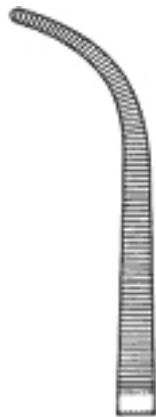

ZI-04-449-00
11 1/2"



ZI-04-449-01
11 1/2"

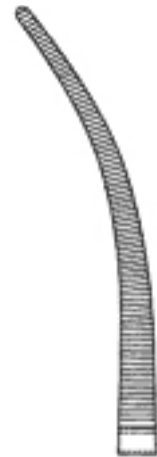

ZI-04-449-06
11 3/4"





ZARYAB
I N S T R U M E N T S

Products that saves life

Forceps



Dissecting and Ligature Forceps
Overholt-Mini
ZI-04-450-01
6"



Dissecting and Ligature Forceps
Overholt-Mini
ZI-04-450-02
8"



Forceps



Dissecting and Ligature Forceps
Overholt-Mini
ZI-04-450-01
6"



Dissecting and Ligature Forceps
Overholt-Mini
ZI-04-450-02
8"



ZARYAB
I N S T R U M E N T S

Products that saves life

Forceps

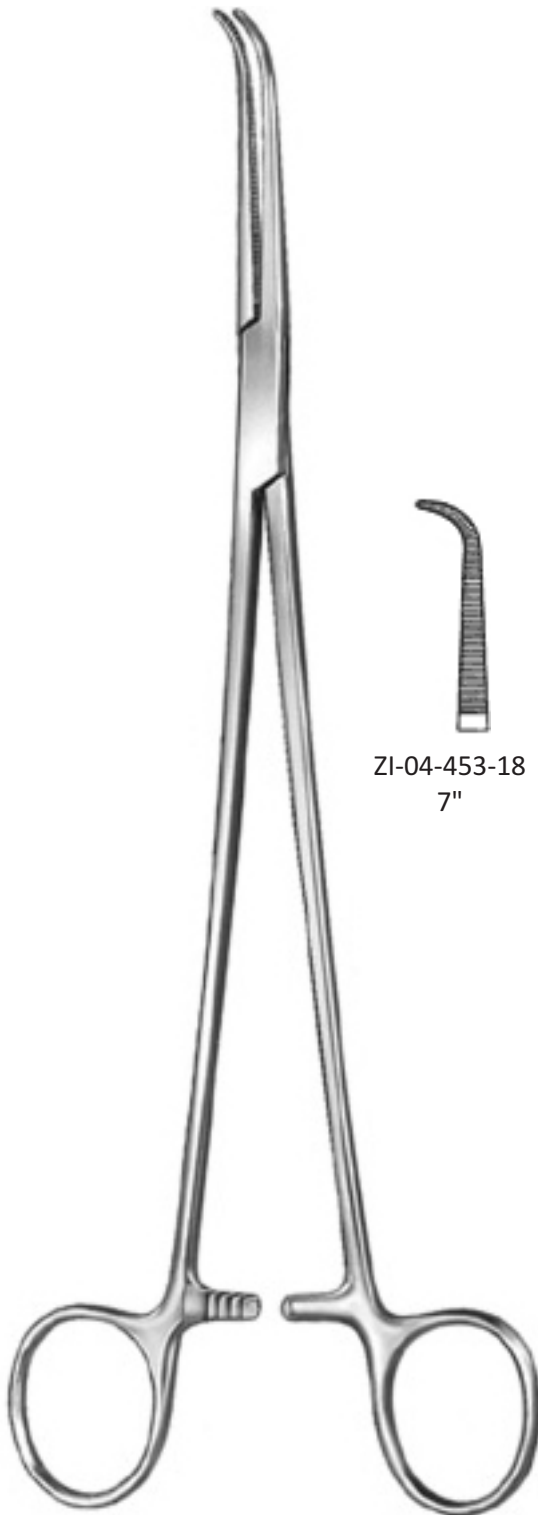

ZI-04-453-18
7"



ZI-04-453-22
8 3/4"



ZI-04-453-25
9 3/4"



ZI-04-453-28
11 1/4"

Dissecting and Ligature Forceps
Mini-Gemini



Dissecting and Ligature Forceps
Rumel



ZI-04-461-01
9 1/2"
Fig. 1



ZI-04-461-02
9 1/4"
Fig. 2

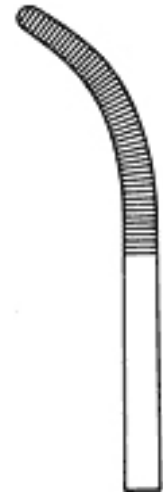

ZI-04-461-03
9"
Fig. 3



ZI-04-461-04
9 1/2"
Fig. 4



ZI-04-461-05
9 1/4"
Fig. 5



ZI-04-469-01
11 1/2"

ZI-04-469-02
11 1/4"

Dissecting and Ligature Forceps
Zenker



Dissecting and Ligature Forceps
Mixer-Baby
ZI-04-471-14
5 1/4"



Forceps

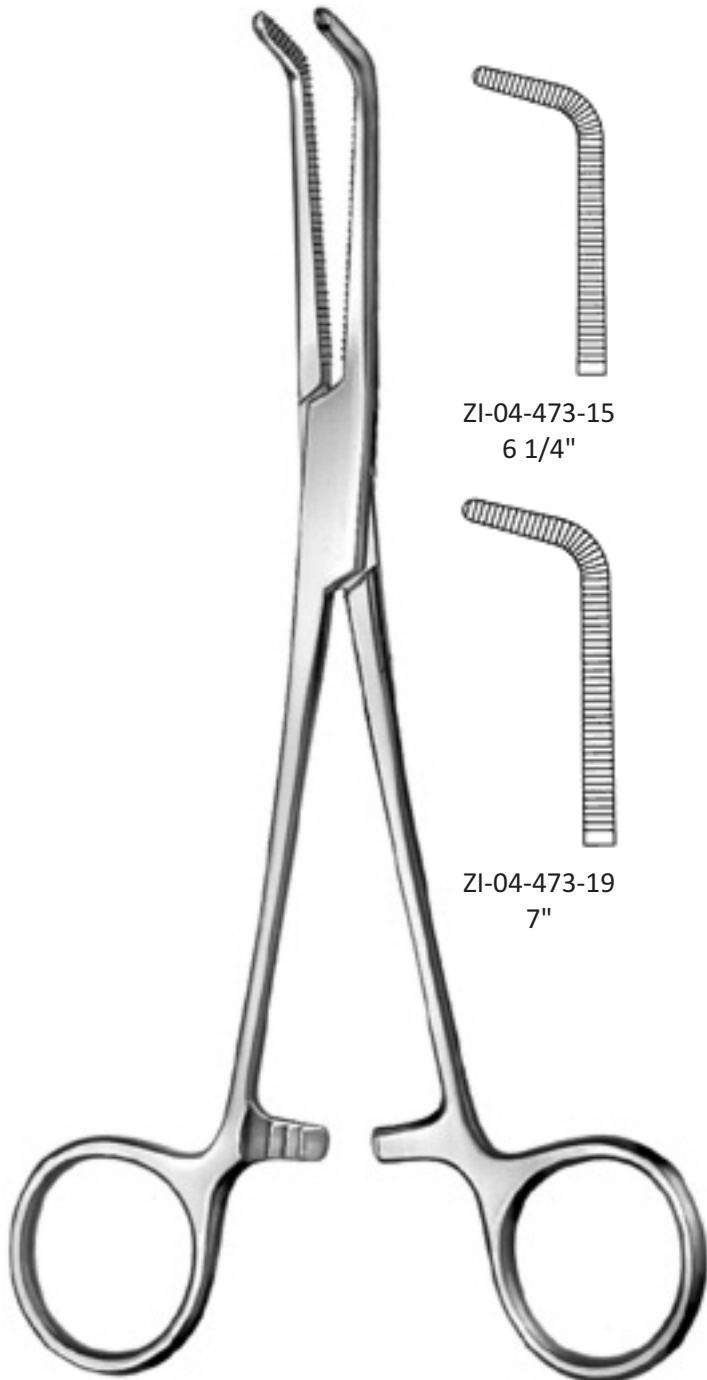

ZI-04-473-15
6 1/4"

ZI-04-473-19
7"

Dissecting and Ligature Forceps
Mixer



Dissecting and Ligature Forceps
Mixer-O'Shaughnessy
ZI-04-479-19
7"



Forceps

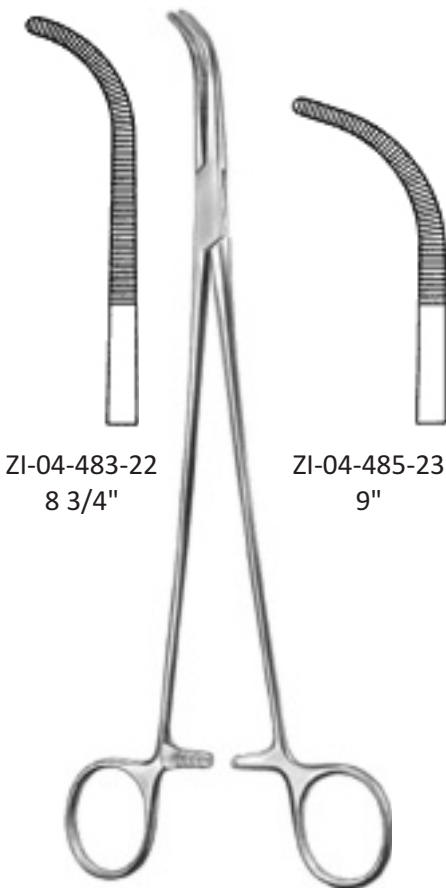

ZI-04-483-22
8 3/4"

ZI-04-485-23
9"

Dissecting and Ligature Forceps
Mixer

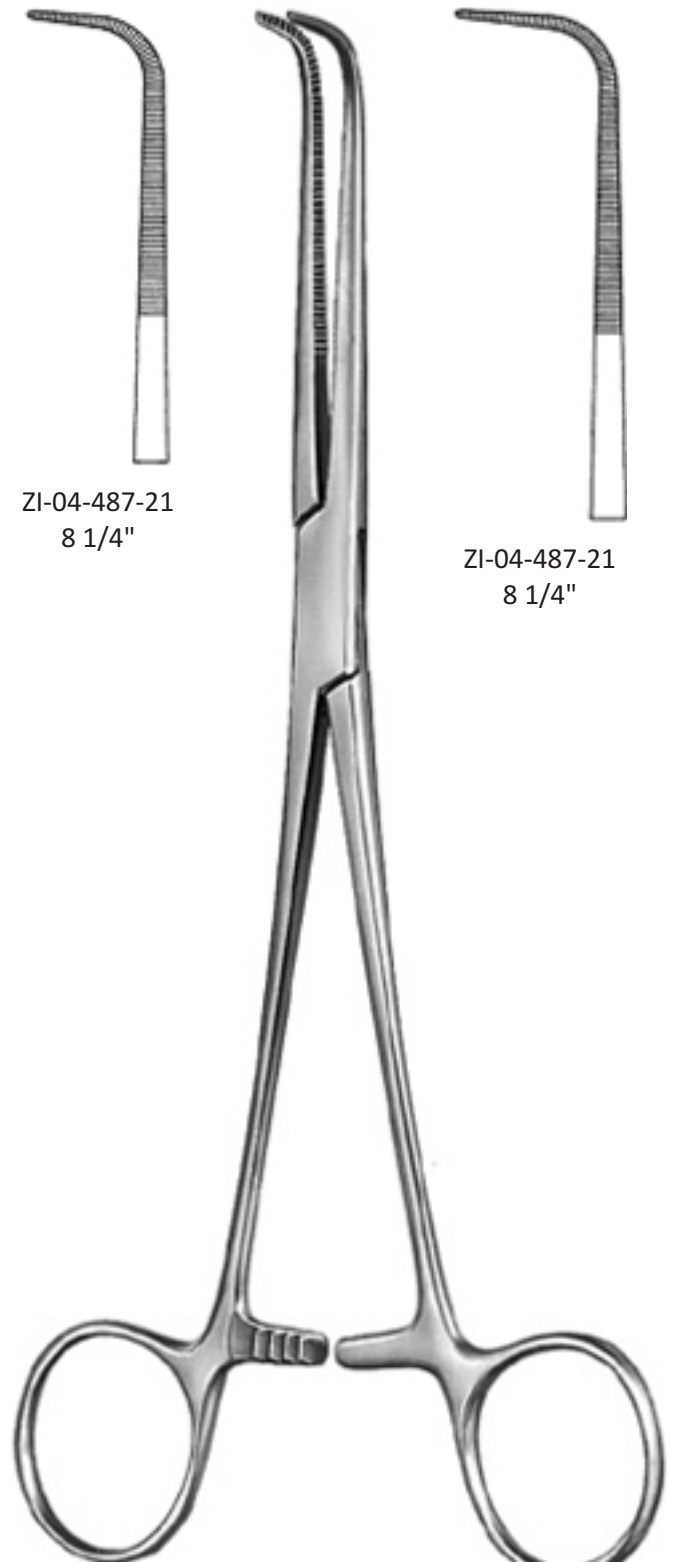

ZI-04-487-21
8 1/4"

ZI-04-487-21
8 1/4"

Dissecting and Ligature Forceps
Wickström



ZI-04-491-22
8 3/4"

Dissecting and Ligature Forceps
Mixer

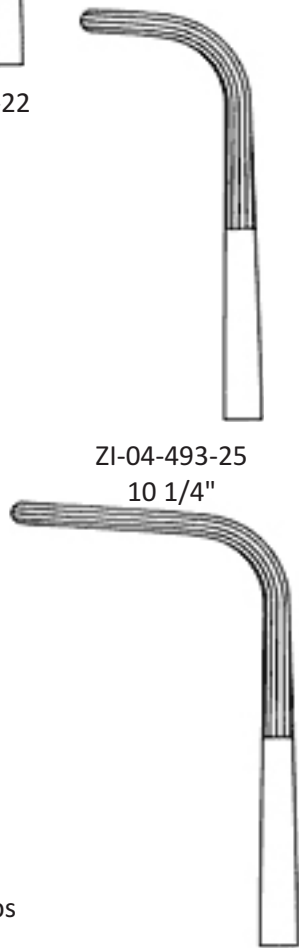

ZI-04-493-25
10 1/4"

ZI-04-495-28
11"



Dissecting and Ligature Forceps
Mc Quigg-Mixer
ZI-04-497-22
9 1/4"



ZI-04-511-19
7 3/4"

Dissecting and Ligature Forceps
Lower
ZI-04-501-18
7 1/4"



ZI-04-513-23
8 3/4"

Bile Duct Clamp
Lahey



Forceps

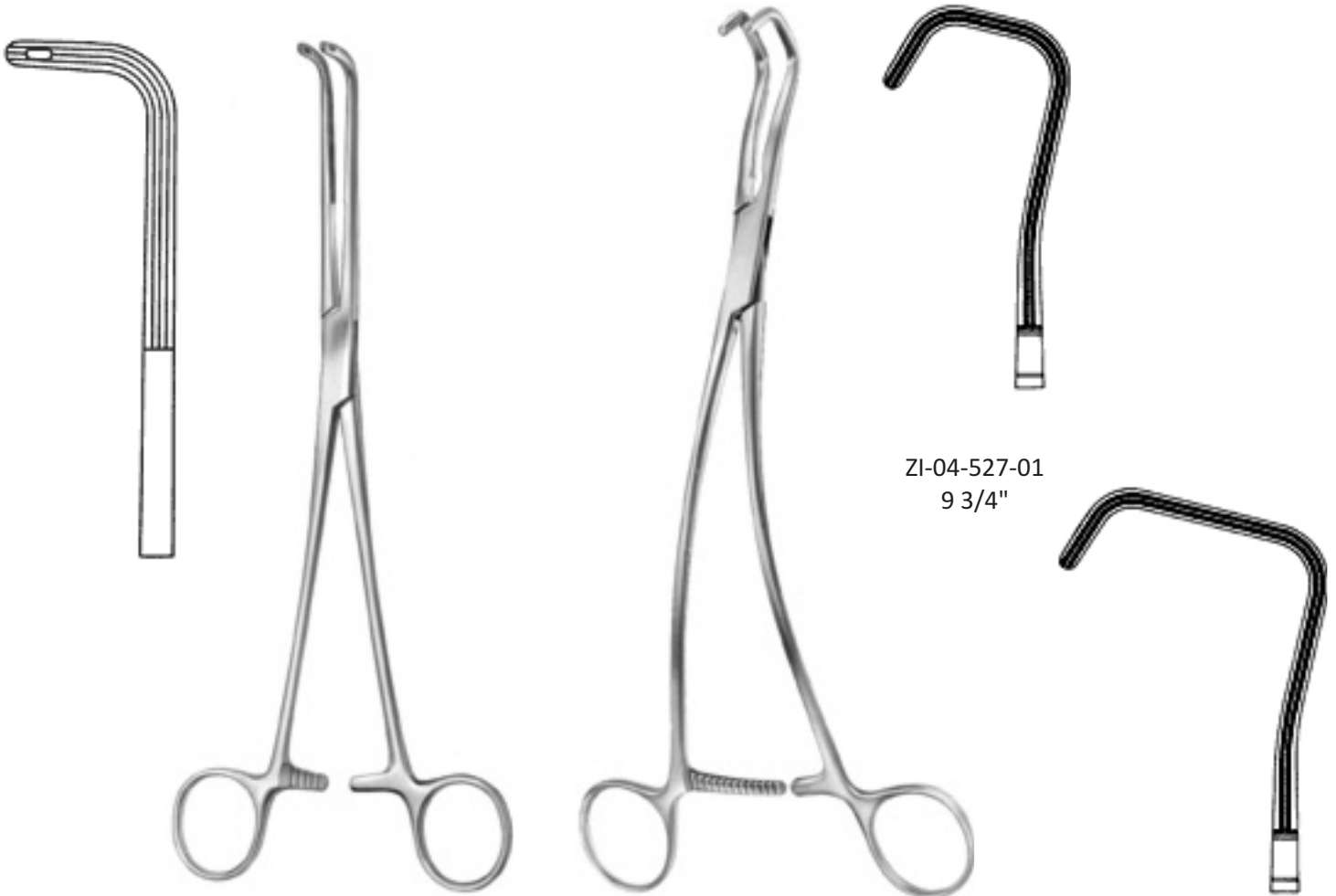

Dissecting and Ligature Forceps
Finochietto
ZI-04-521-24
9 1/2"

Tangential Forceps
Uro-Tangential

ZI-04-527-01
9 3/4"

ZI-04-527-01
9 3/4"



ZARYAB
I N S T R U M E N T S

Products that saves life

Forceps



Kidney Pedicle Clamp
Guyon



ZI-04-529-23
9"



ZI-04-529-24
9 1/2"



ZI-04-531-20
7 3/4"

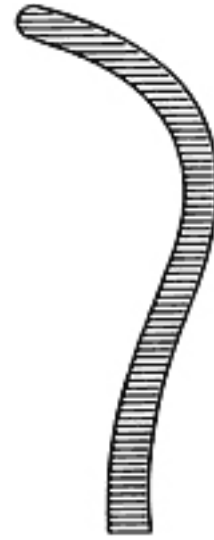

ZI-04-531-22
8 1/2"



Kidney Pedicle Clamp
Guyon



ZI-04-531-24
9 1/2"



ZI-04-533-23
9 1/2"



Bile Duct Clamp
Desjardins
ZI-04-571-21
8 1/4"



Dissecting and Ligature Forceps
Kelly

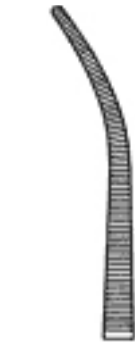

ZI-04-577-19
7 3/4"
Fig. 1



ZI-04-577-22
8 3/4"
Fig. 1



ZI-04-577-24
9 3/4"
Fig. 1

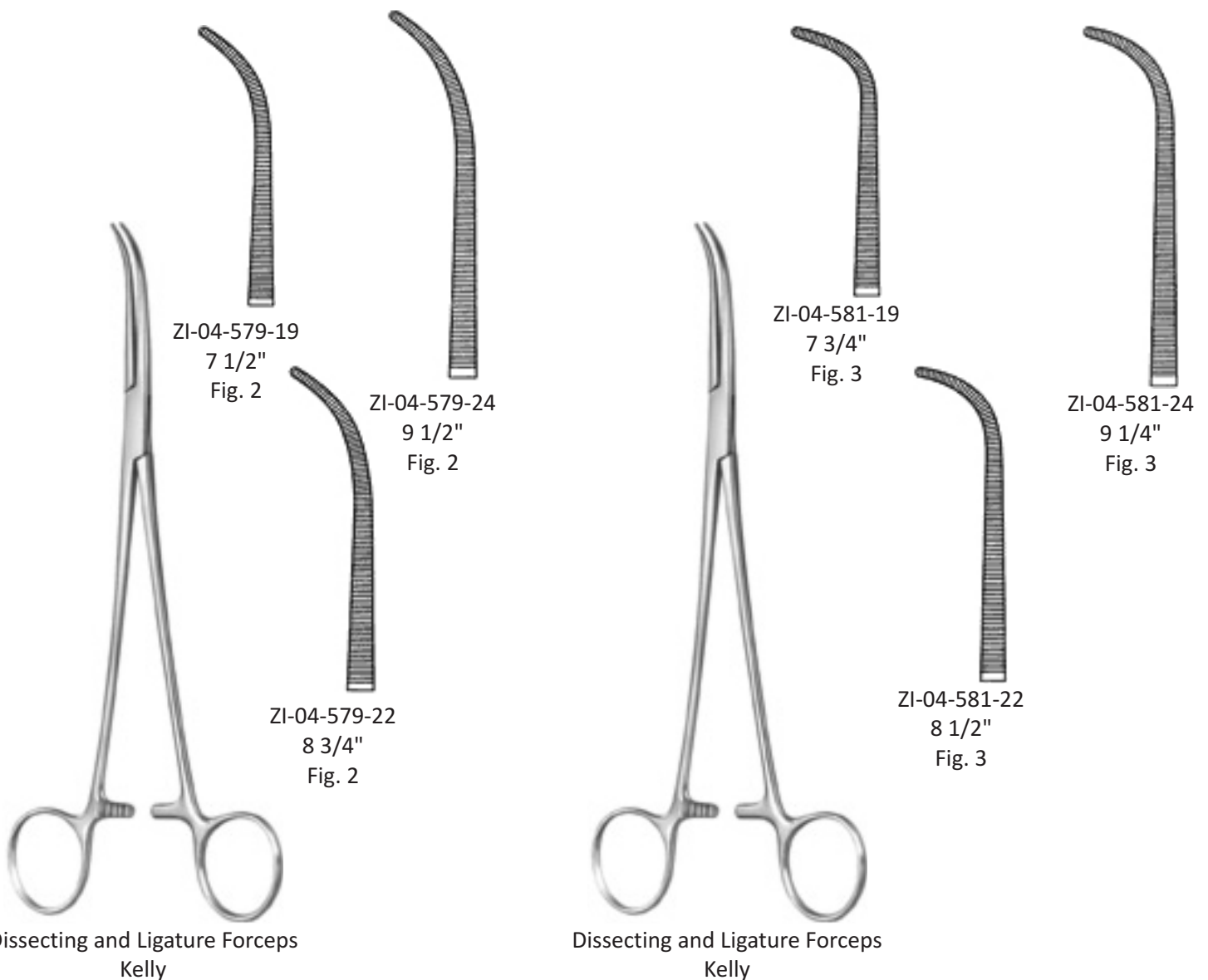



ZARYAB
I N S T R U M E N T S

Products that saves life

Forceps



Dissecting and Ligature Forceps
ZI-04-583-28
11"

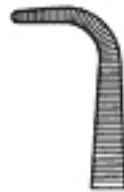

Dissecting and Ligature Forceps
Meeker
ZI-04-585-28
11"



Forceps

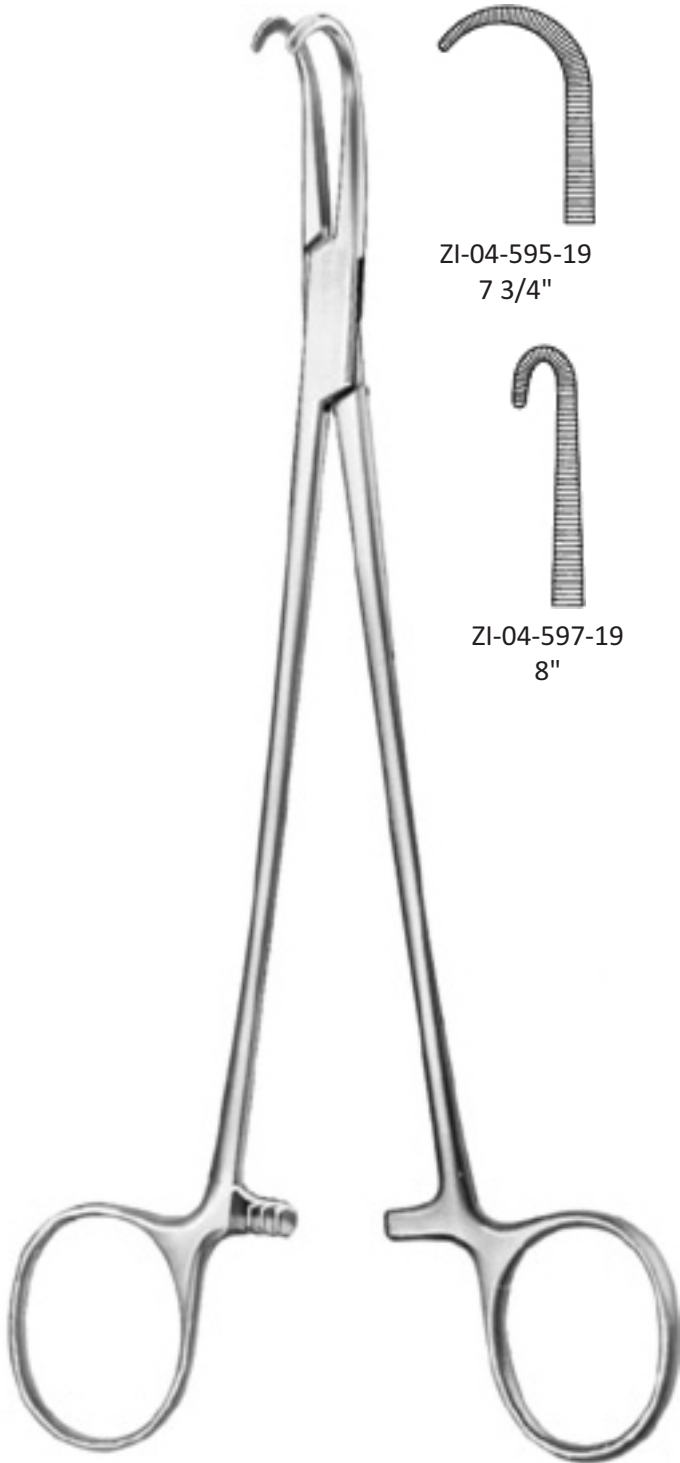

Haemostatic Forceps
Negus

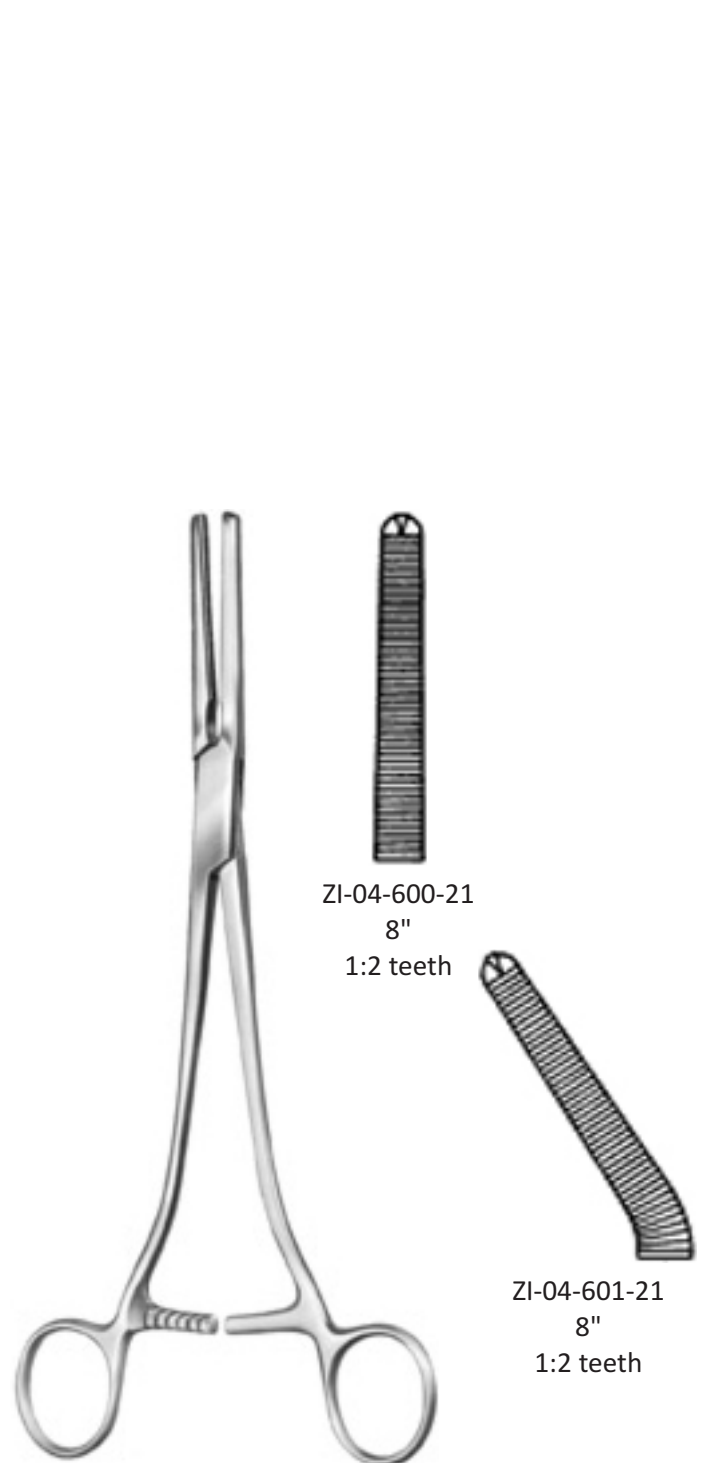

Hysterectomy Forceps
Phaneuf

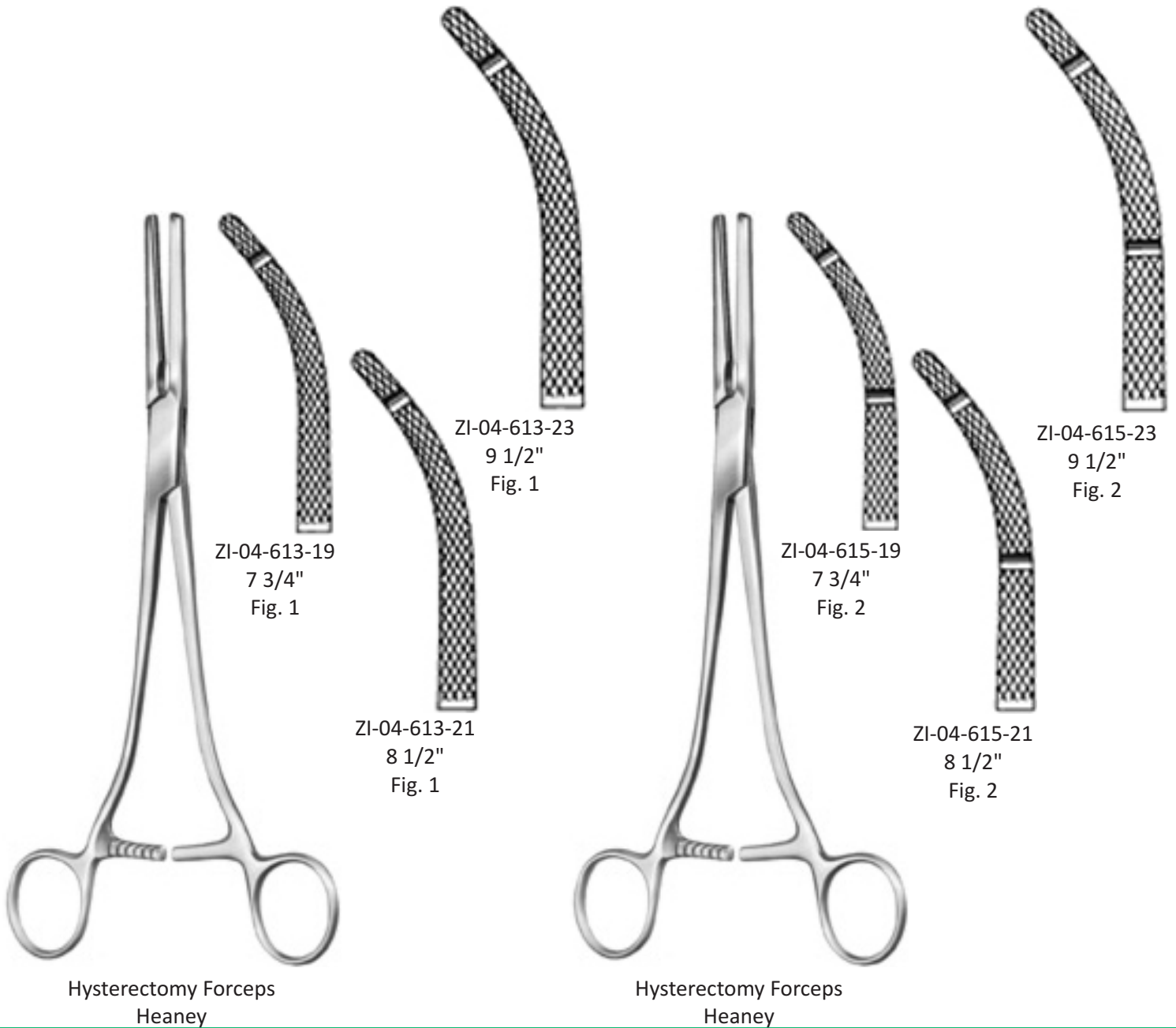



ZARYAB
I N S T R U M E N T S

Products that saves life

Forceps



Vaginal Clamp
Wertheim-Cullen
ZI-04-625-21
8 1/4"



Forceps



Hysterectomy Forceps
Rogers

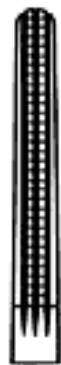

ZI-04-635-10
8 1/2"
Fig. 1



ZI-04-635-20
8 1/4"
Fig. 2



ZI-04-635-30
8"
Fig. 3

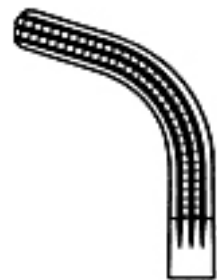

ZI-04-635-40
8"
Fig. 4



ZI-04-637-10
10"
Fig. 1



ZI-04-637-20
9 3/4"
Fig. 2

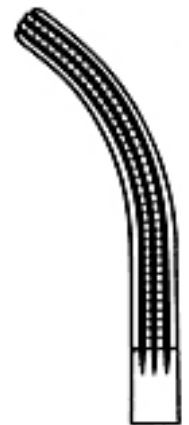

ZI-04-637-30
9 3/4"
Fig. 3



Hysterectomy Forceps
Moynihan

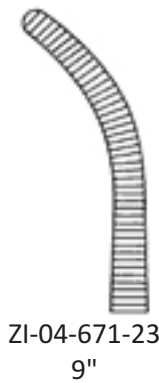



Hysterectomy Forceps
Wertheim
ZI-04-697-25
10 1/4"

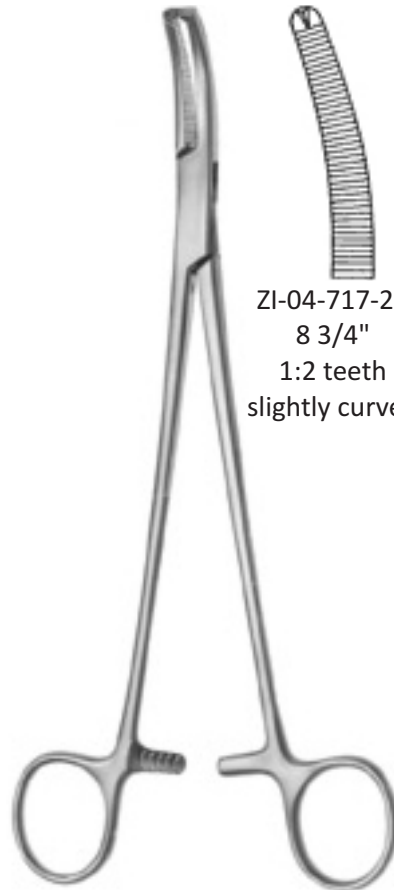

ZI-04-717-22
8 3/4"
1:2 teeth
slightly curved

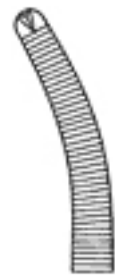

ZI-04-719-23
8 3/4"
1:2 teeth
more curved



Forceps



Peritoneum Forceps
Mikulicz, Baby
ZI-04-721-14
5 3/4"
1:2 teeth

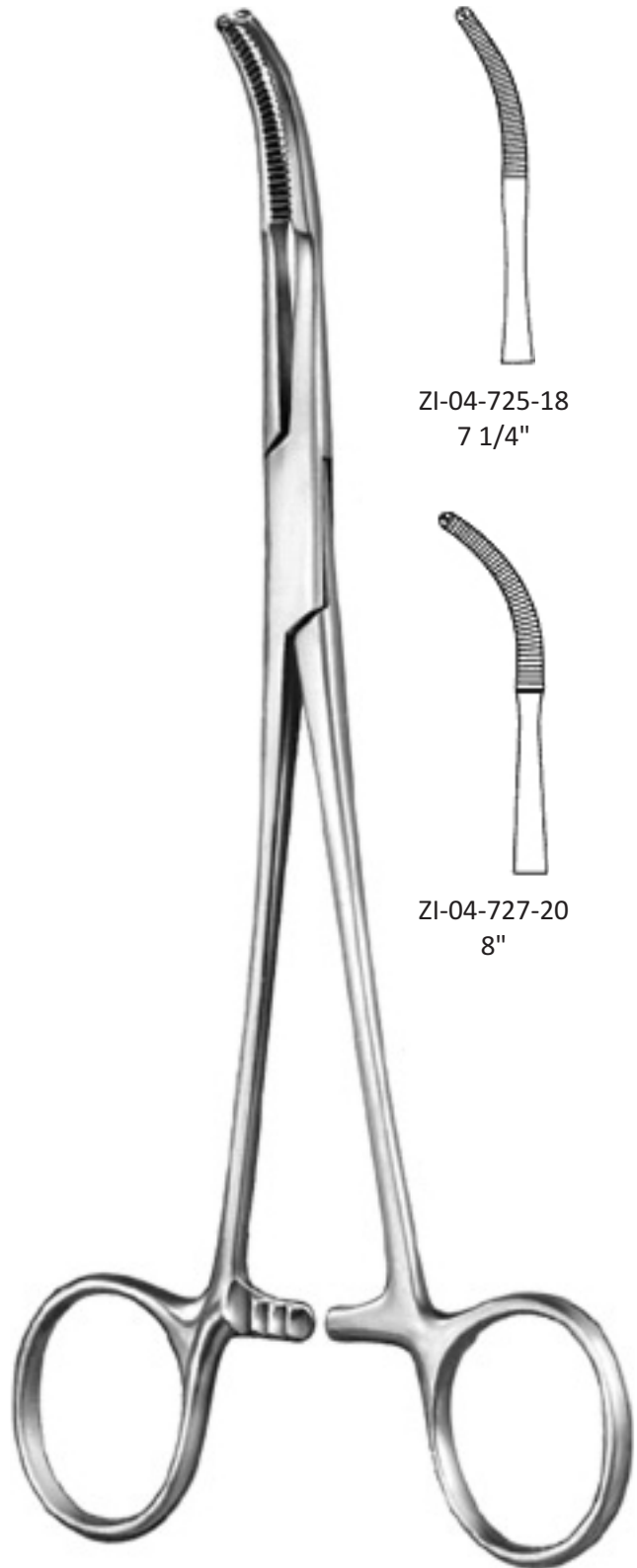

Peritoneum Forceps
Mikulicz

ZI-04-725-18
7 1/4"

ZI-04-727-20
8"



Forceps



Peritoneum Forceps
Mikulicz
ZI-04-745-20
8"



Peritoneum Forceps
Mikulicz
ZI-04-749-21
8"



Forceps



ZI-04-751-20
8 1/4"
1:2 teeth



ZI-04-753-20
8 1/4"
1:2 teeth

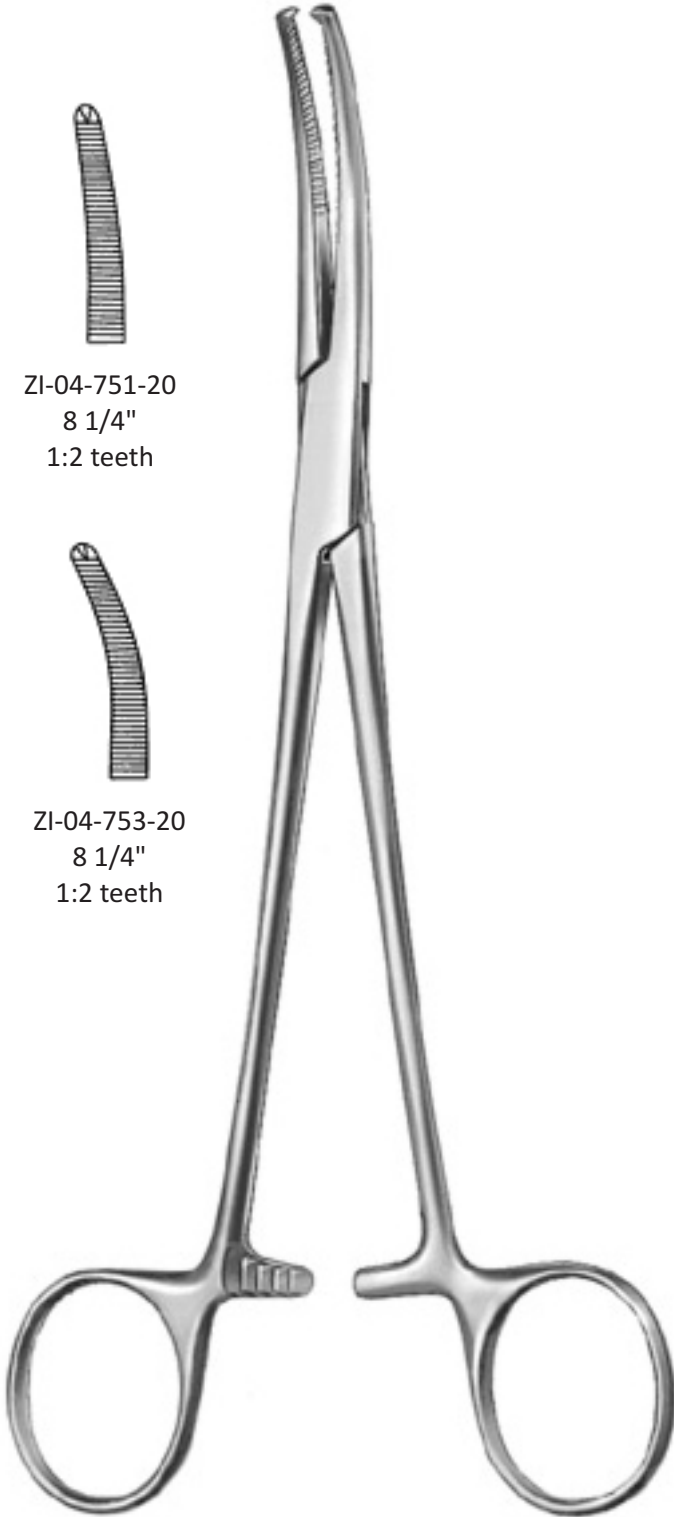

Peritoneum Forceps
Faure



Towel Clamp
Schädel
ZI-04-875-09
3 1/2"



Towel Clamp
Jones
ZI-04-881-05
2 1/4"



Towel Clamp
Jones
ZI-04-881-09
3 1/4"



Towel Clamp
Jones-Martin
ZI-04-883-09
3 1/4"
with tube holder



Forceps



Towel Clamp
Backhaus
ZI-04-909-11
4 1/2"

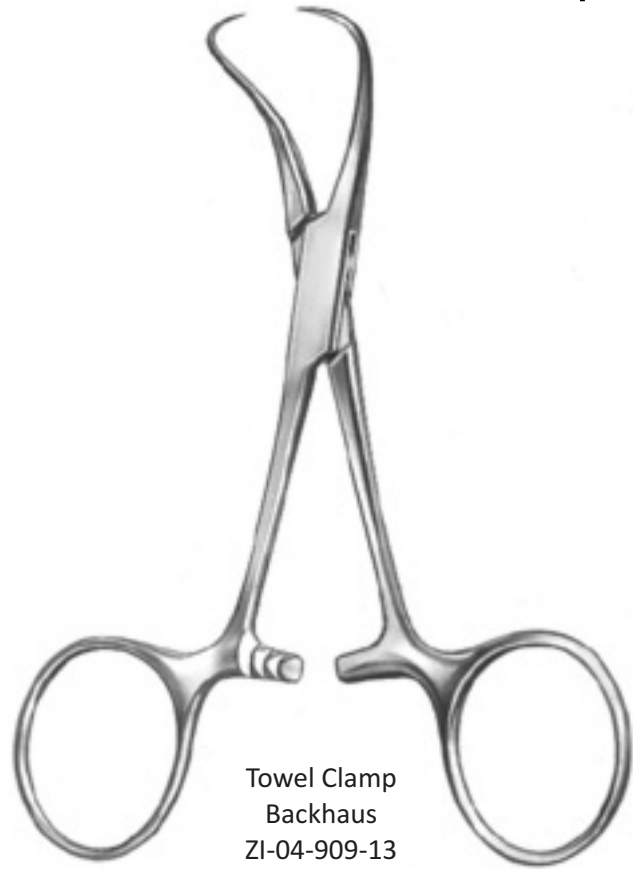

Towel Clamp
Backhaus
ZI-04-909-13
5"



Towel Clamp
Backhaus
ZI-04-913-11
4 1/2"



Towel Clamp
Backhaus
ZI-04-915-08
3 1/2"



ZARYAB
I N S T R U M E N T S

Products that saves life

Forceps



Towel Clamp
Backhaus
ZI-04-915-11
4 1/2"



ZI-04-915-13
5"



ZI-04-915-15
6 1/4"

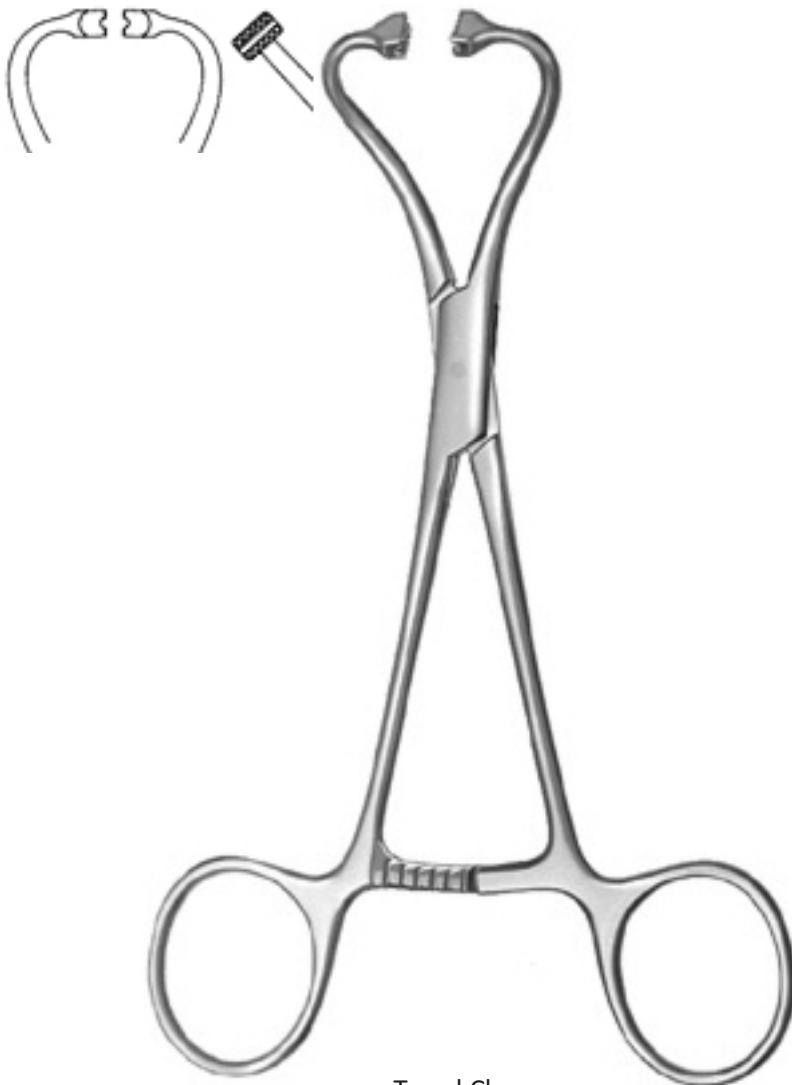

Towel Clamp
Peers-Bertram modif.
ZI-04-916-15
6"



Towel Clamp
Röder
ZI-04-917-13
5 1/4"

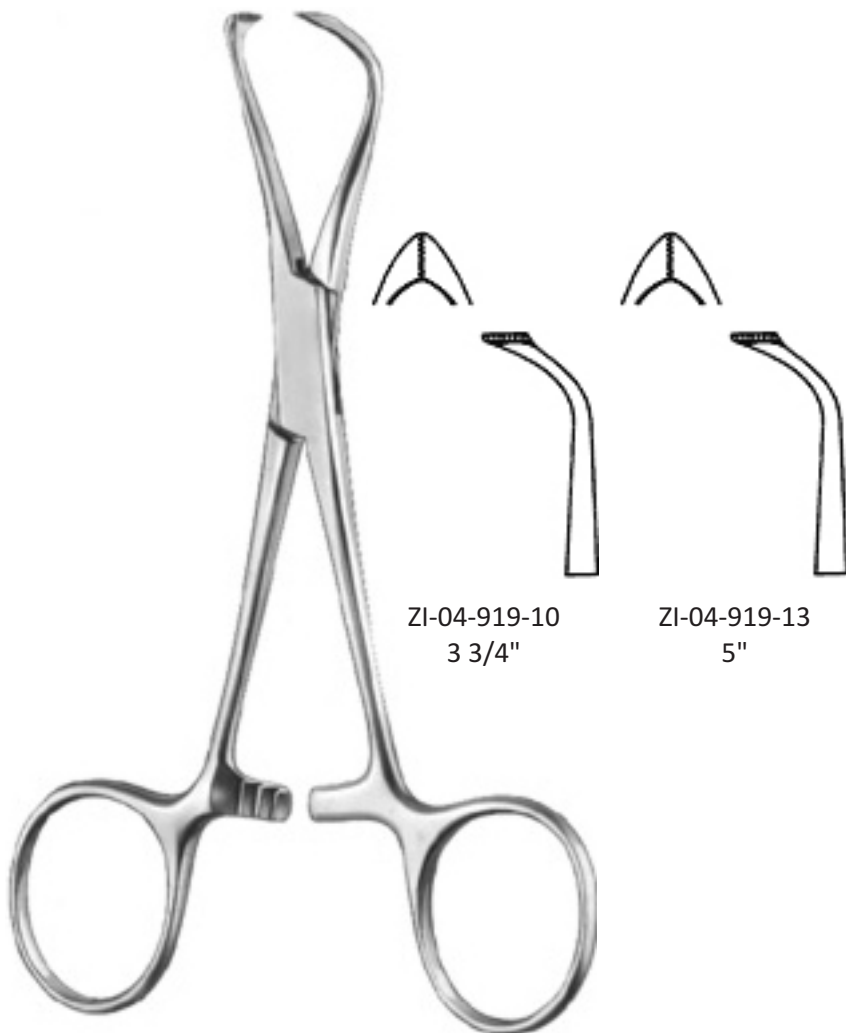

Towel Clamp
Lorna



Towel Clamp
Bernhard
ZI-04-921-16
6 1/2"



Forceps

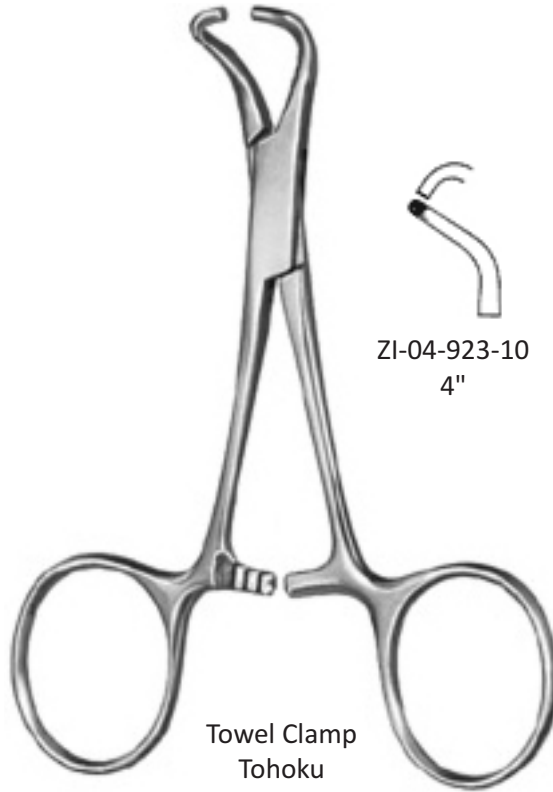

ZI-04-923-10
4"



ZI-04-923-13
5 1/4"

Towel Clamp
Tohoku

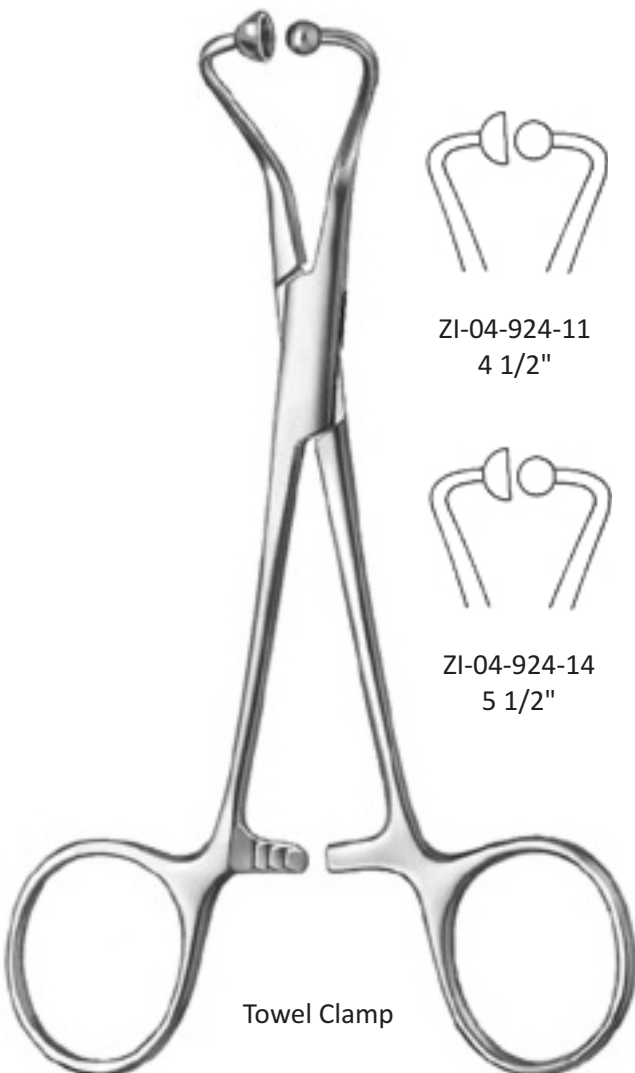

ZI-04-924-11
4 1/2"



ZI-04-924-14
5 1/2"

Towel Clamp

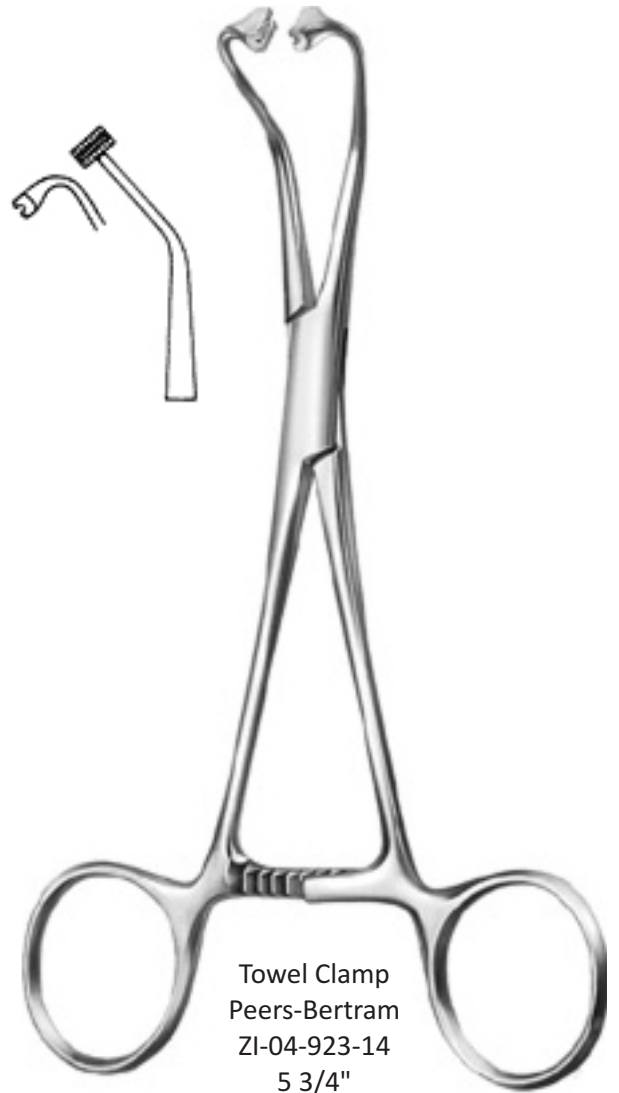

Towel Clamp
Peers-Bertram
ZI-04-923-14
5 3/4"



ZARYAB
INSTRUMENTS

Products that saves life

Forceps



Towel Clamp
Lane
ZI-04-935-20
7 3/4"

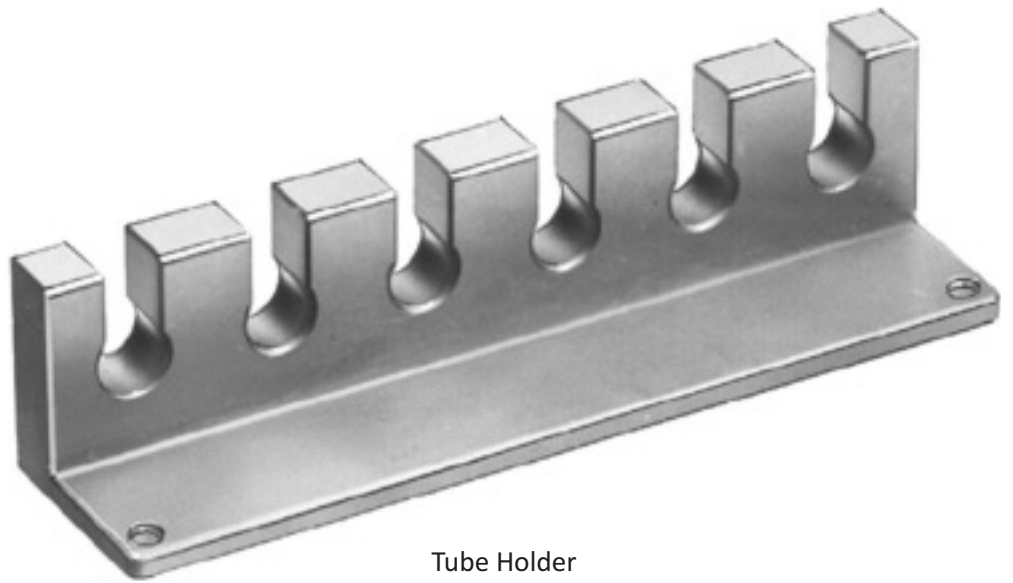

Tube Holder
ZI-04-939-06



ZARYAB
INSTRUMENTS

Products that saves life

Forceps



Tubing Clamp
ZI-04-940-14
5 1/2"



Tubing Clamp
ZI-04-942-16
6 1/2"



Tubing Clamp



ZI-04-944-15
6"



ZI-04-944-18
7 1/2"



ZI-04-944-20
8"



ZARYAB
INSTRUMENTS

Products that saves life

Forceps



Tubing Clamp



ZI-04-946-15
6"



ZI-04-946-18
7 1/2"



ZI-04-946-20
8"



Forceps



ZI-05-100-22
8 3/4"

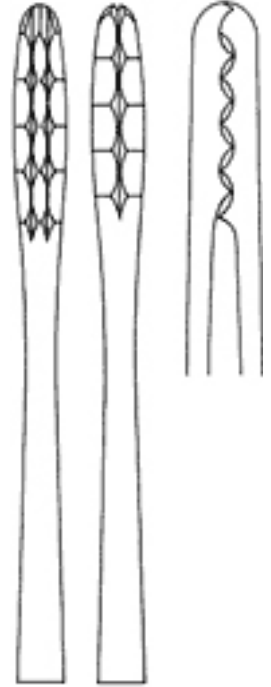

ZI-05-100-27
10 1/2"



Dressing Forceps
Ulrich



ZI-05-101-22
8 3/4"



ZI-05-101-27
10 1/2"



Forceps



Sinus Forceps
Lister

ZI-05-110-13
5"



ZI-05-110-13
5"



ZI-05-110-13
5"



Dressing Forceps
Martin

ZI-05-120-17
7"



ZI-05-120-17
7"



Forceps



Dressing Forceps
Gross-Maier



ZI-05-222-20
8"



ZI-05-222-22
8 3/4"



ZI-05-222-27
10 1/2"



ZI-05-223-20
8"



ZI-05-223-22
8 1/2"



ZI-05-223-27
10 1/4"



ZARYAB
I N S T R U M E N T S

Products that saves life

Forceps

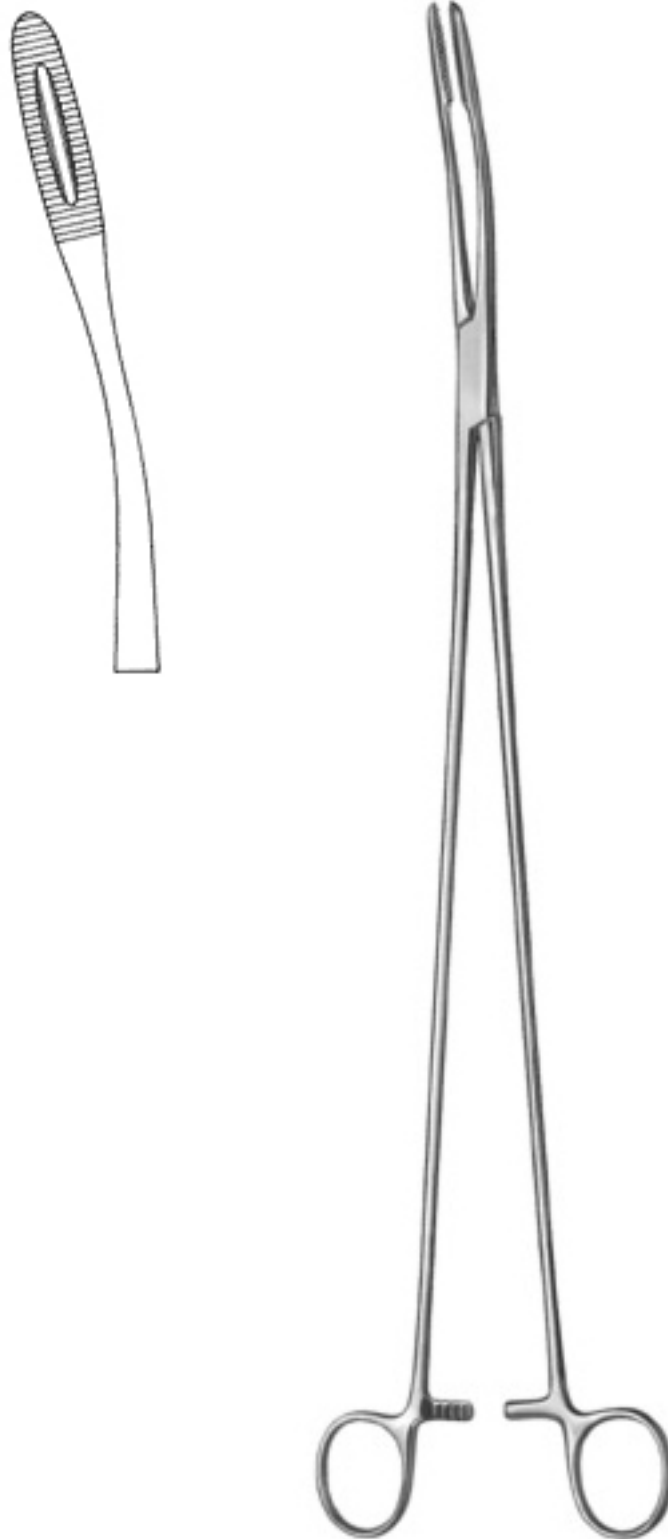

Tunneling Forceps
ZI-05-231-40
15 1/2"

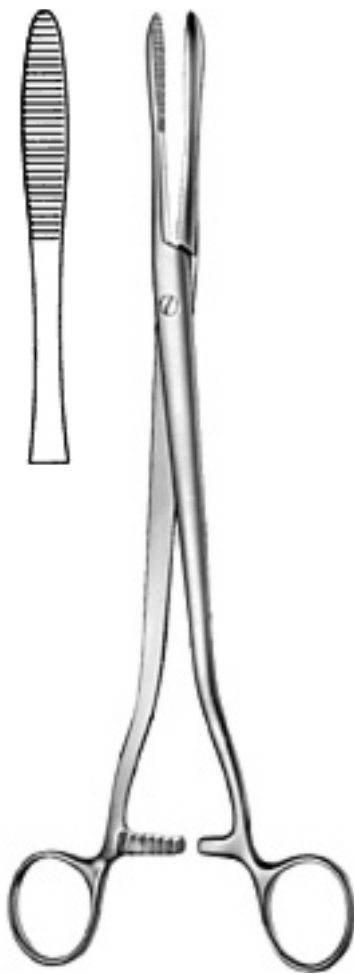

Dressing Forceps
Collin
ZI-05-286-25
10"



Dressing Forceps
Cheron
ZI-05-290-25
9 1/4"

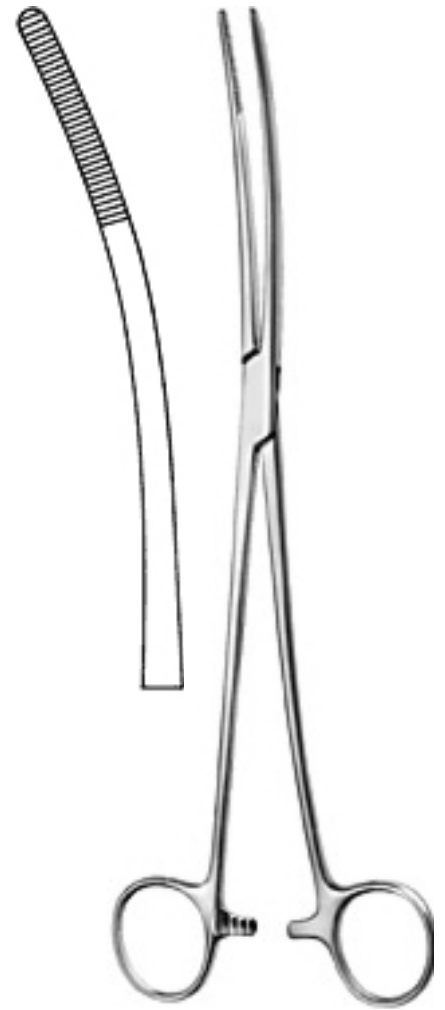

Sponge Forceps
Bozemann
ZI-05-313-26
10 1/4"



Forceps



ZI-05-350-25
9 3/4"



ZI-05-352-18
7"



ZI-05-352-20
8"



ZI-05-352-25
9 3/4"



Sponge Forceps
Foerster



ZI-05-353-25
9 3/4"



ZI-05-355-18
7"

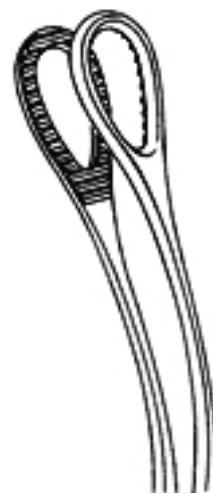

ZI-05-355-20
8"



ZI-05-355-25
9 3/4"



Forceps



Sponge Forceps
Foerster



ZI-05-360-25
9 3/4"

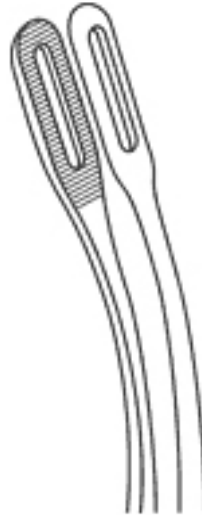

ZI-05-361-25
9 3/4"



Sponge Forceps
Rampley



ZI-05-370-18
7 1/4"



ZI-05-370-25
9 3/4"



Products that saves life

ZARYAB

I N S T R U M E N T S

 Harar, Wazirabad Road, Sialkot-51310, Pir Sabz Rd, Pir Sabz, Pakistan

 +92 52 3573775

 +92 52 3573776

 +92 333 8608580 , +92 333 3349600

 info@zaryabinstruments.com

 sales@zaryabinstruments.com

 www.zaryabinstruments.com