

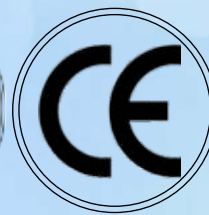

*Products that saves life*

# ZARYAB

## INSTRUMENTS



## HYGIENE & STORAGE

### Catalogue





**ZARYAB**  
I N S T R U M E N T S

*Products that saves life*

## Hygiene Storage



ZI-28-004-07  
Storage strip only,  
without plug-in elements  
Storage strip



ZI-28-005-02  
Plug-in Element  
package of 16 pieces  
Plug-in Element

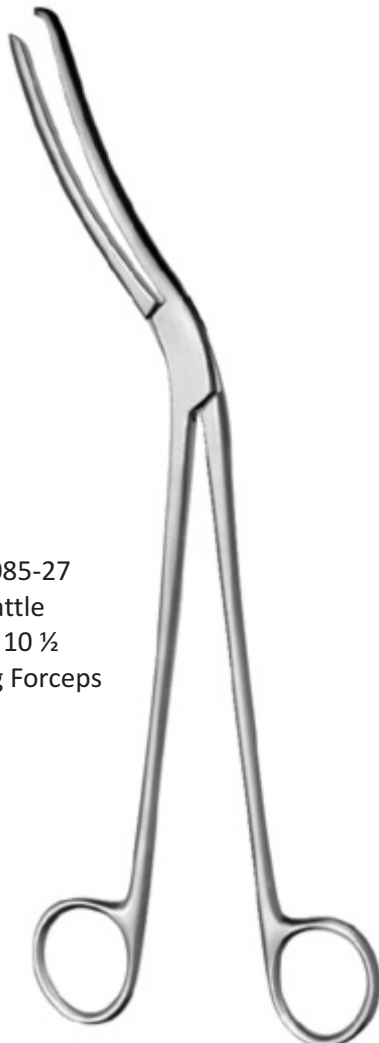

ZI-28-085-27  
Cheattle  
27cm 10 ½  
Sterilizing Forceps

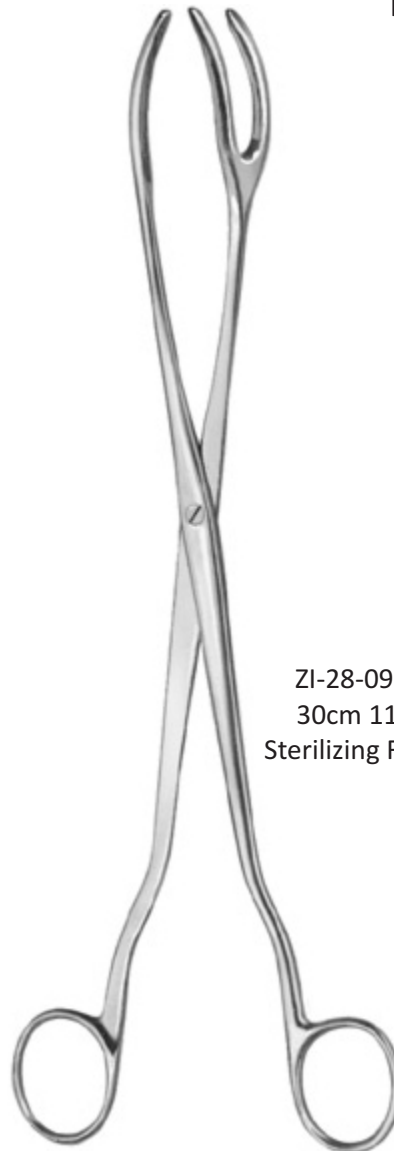

ZI-28-091-30  
30cm 11 ¾  
Sterilizing Forceps



**ZARYAB**  
INSTRUMENTS

*Products that saves life*

## Hygiene Storage

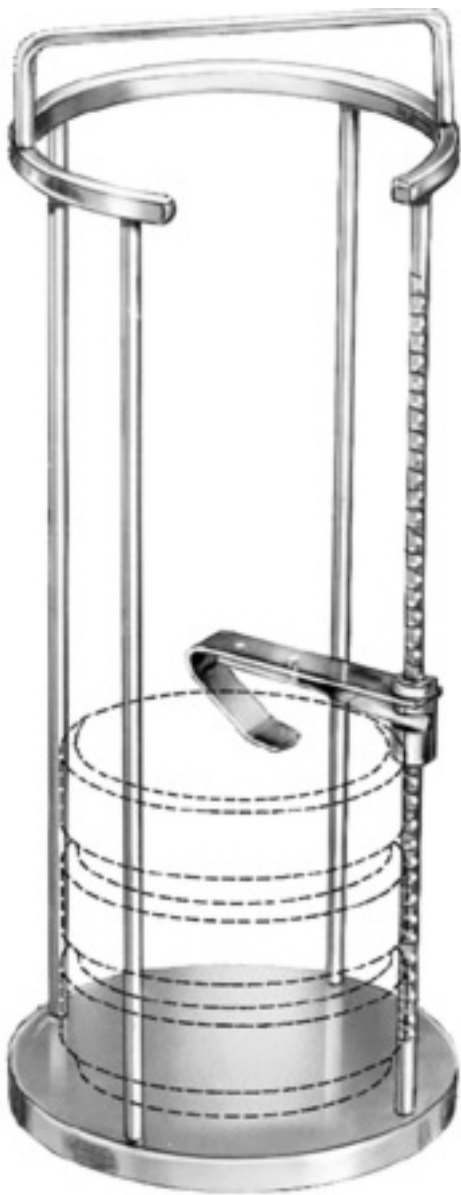

ZI-28-142-10  
Storage Rack for Petri Dishes  
for up to 10  
dishes of  
8 - 10 cm Ø

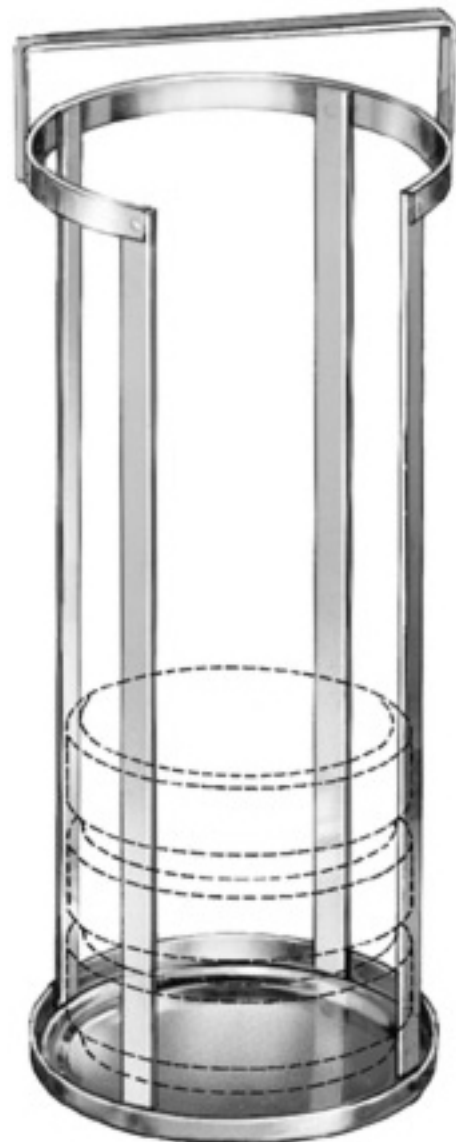

ZI-28-141-10  
Storage Rack for Petri Dishes  
for up to 10  
dishes of 8 - 10 cm Ø  
with fixation device



**ZARYAB**  
INSTRUMENTS

*Products that saves life*

Hygiene  
Storage



ZI-28-162-20  
Sauerbruch  
Needle Case  
210 x 125 x 17 mm  
perforated lid and bottom



ZI-28-164-20  
Sauerbruch  
Needle Case  
210 x 125 x 17 mm  
perforated lid and bottom



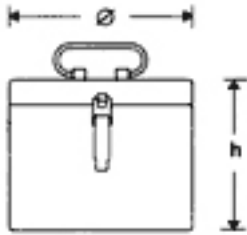

- ZI-28-200-08 Schimmelbusch  
Dressing Sterilizing Drum  $\varnothing$  x h without filter laterally perforated lockable by sliding mechanism
- ZI-28-200-12 Schimmelbusch  
Dressing Sterilizing Drum  $\varnothing$  x h without filter laterally perforated lockable by sliding mechanism
- ZI-28-200-14 Schimmelbusch  
Dressing Sterilizing Drum  $\varnothing$  x h without filter laterally perforated lockable by sliding mechanism
- ZI-28-200-16 Schimmelbusch  
Dressing Sterilizing Drum  $\varnothing$  x h without filter laterally perforated lockable by sliding mechanism
- ZI-28-200-17 Schimmelbusch  
Dressing Sterilizing Drum  $\varnothing$  x h without filter laterally perforated lockable by sliding mechanism
- ZI-28-200-19 Schimmelbusch  
Dressing Sterilizing Drum  $\varnothing$  x h without filter laterally perforated lockable by sliding mechanism
- ZI-28-200-20 Schimmelbusch  
Dressing Sterilizing Drum  $\varnothing$  x h without filter laterally perforated lockable by sliding mechanism
- ZI-28-200-23 Schimmelbusch  
Dressing Sterilizing Drum  $\varnothing$  x h without filter laterally perforated lockable by sliding mechanism
- ZI-28-200-24 Schimmelbusch  
Dressing Sterilizing Drum  $\varnothing$  x h without filter laterally perforated lockable by sliding mechanism
- ZI-28-200-28 Schimmelbusch  
Dressing Sterilizing Drum  $\varnothing$  x h without filter laterally perforated lockable by sliding mechanism
- ZI-28-200-29 Schimmelbusch  
Dressing Sterilizing Drum  $\varnothing$  x h without filter laterally perforated lockable by sliding mechanism
- ZI-28-200-33 Schimmelbusch  
Dressing Sterilizing Drum  $\varnothing$  x h without filter laterally perforated lockable by sliding mechanism
- ZI-28-200-34 Schimmelbusch  
Dressing Sterilizing Drum  $\varnothing$  x h without filter laterally perforated lockable by sliding mechanism
- ZI-28-200-38 Schimmelbusch  
Dressing Sterilizing Drum  $\varnothing$  x h without filter laterally perforated lockable by sliding mechanism
- ZI-28-200-39 Schimmelbusch  
Dressing Sterilizing Drum  $\varnothing$  x h without filter laterally perforated lockable by sliding mechanism



**ZARYAB**  
I N S T R U M E N T S

*Products that saves life*

## Hygiene Storage



ZI-28-296-75  
Storage Case  
120 x 65 x 13 mm  
without contents



ZI-28-296-76  
Silicone Tape  
for storing micro bull  
dog clips Silicone Tape



ZI-28-298-75  
Storage Case  
120 x 65 x 13 mm  
with spiral spring  
without contents

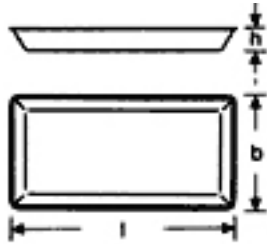

ZI-55-300-50  
Needle Casel x b x h

ZI-55-300-65  
Needle Casel x b x h

ZI-55-300-75  
Needle Casel x b x h

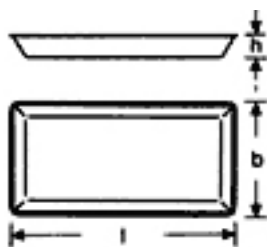

ZI-28-302-50  
Needle Casel x b x hper  
forated lid and bottom

ZI-28-302-65  
Needle Casel x b x hper  
forated lid and bottom

ZI-28-302-75  
Needle Casel x b x hper  
forated lid and bottom



**ZARYAB**  
I N S T R U M E N T S

Products that saves life

Hygiene  
Storage



ZI-28-309-65  
Needle Case  
Ø 65 mm x 15 mm  
complete with perforated  
interior box

ZI-28-310-65  
Interior Box Ø 62 mm x 13 mm  
Interior Box perforated  
lid and bottom



ZI-28-313-08  
Martin-Proper  
Drill Collecting Box  
Ø 78 mm x 63 mm  
for disposal of used burs  
Drill Collecting Box slotted lid

ZI-28-335-01  
Needle Case  
150 x 95 x 13 mm







ZI-28-335-02  
Needle Case  
150 x 95 x 13 mm  
perforated lid  
and bottom



ZI-28-335-03  
Needle Case  
150 x 95 x 13 mm  
perforated bottom



ZI-28-335-05  
Needle Case  
150 x 95 x 13 mm  
perforated lid  
and bottom



ZI-28-337-01  
Needle Case  
150 x 95 x 13 mm



ZI-28-337-02  
Needle Case  
150 x 95 x 13 mm  
perforated lid and bottom



ZI-28-340-02  
Needle Tray  
150 x 95 x 11 mm perforated bottom  
Needle Tray



**ZARYAB**  
INSTRUMENTS

Products that saves life

## Hygiene Storage



ZI-28-348-00  
Storing Cup

Ø 75 mm x 75 mm  
for micro instruments  
with exchangeable silicone plate



ZI-28-348-01  
Silicone Plate

Silicone plate



ZI-28-358-25  
Martin

25cm 9 3/4"  
Dressing Forceps in jar,  
with cap  
jar 20,5 cm high  
with 25 cm long  
dressing forceps



ZI-28-358-32  
Martin

32cm 12 1/2"  
Dressing Forceps in jar,  
with cap  
jar 25,5 cm high  
with 32 cm long  
dressing forceps



ZI-28-395-25  
Martin-ECO

Storing Tray with fixation bar  
ref. 55-395-26, 16 each plug-in elements  
ref. ZI-55-005-02 and 2  
each storage strips  
ref. ZI-55-004-07240 x 85 x 30 mm  
for delicate instruments up to 23 cm



ZI-28-395-18  
Martin-ECO

Storing Tray with fixation bar  
ref. ZI-55-395-26, 16 each plug-in elements  
ref. ZI-55-005-02 and 2 each storage strips  
ref. ZI-55-004-07180 x 85 x 30 mm  
for delicate instruments up to 17 cm



**ZARYAB**  
I N S T R U M E N T S

*Products that saves life*

## Hygiene Storage



ZI-28-395-26  
Fixation Bar with silicone  
insert Fixation Bar



ZI-28-398-00  
Storing Rackwall-mounted  
model with suspension  
for storage of  
Martin-Deponettes



ZI-28-398-01  
Storing Racktable-top  
model without  
suspension for storage  
of Martin-Deponettes



ZI-28-399-35  
Deponette  
Storage Case  
245 x 135 x 35 mm  
with textile filter  
ref. 55-409-23  
perforated bottom



ZI-28-399-50  
Deponette  
Storage Case  
245 x 135 x 50 mm  
with textile filter  
ref. 55-409-23  
perforated bottom



ZI-28-399-60  
Deponette  
Storage Case  
245 x 135 x 60 mm  
with textile filter  
ref. 55-409-23  
perforated bottom



**ZARYAB**  
I N S T R U M E N T S

*Products that saves life*

Hygiene  
Storage



ZI-28-400-23

Storage Case 230 x 130 x 50 mm perforated lid and bottom with hinged lid

ZI-28-400-26

Storage Case 260 x 150 x 50 mm perforated lid and bottom with hinged lid

ZI-28-400-30

Storage Case 300 x 200 x 50 mm perforated lid and bottom with hinged lid

ZI-28-400-32

Storage Case 325 x 275 x 50 mm perforated lid and bottom with hinged lid

ZI-28-400-42

Storage Case 420 x 175 x 50 mm perforated lid and bottom with hinged lid

ZI-28-402-23

Storage Case 230 x 130 x 75 mm perforated lid and bottom with hinged lid

ZI-28-402-26

Storage Case 260 x 150 x 75 mm perforated lid and bottom with hinged lid

ZI-28-402-30

Storage Case 300 x 200 x 75 mm perforated lid and bottom with hinged lid

ZI-28-402-32

Storage Case 325 x 275 x 75 mm perforated lid and bottom with hinged lid

ZI-28-402-42

Storage Case 420 x 175 x 75 mm perforated lid and bottom with hinged lid





**ZARYAB**  
I N S T R U M E N T S

Products that saves life

## Hygiene Storage



ZI-28-730-00  
Vickers  
12cm 4 3/4"  
K-Wire Dispenser  
wire length  
10 cmØ  
wires 1,0 / 1,2 /  
1,4 / 1,6 mm Ø  
length of  
dispenser 12 cm  
with white  
plastic cap

ZI-28-730-16  
Vickers  
18.5cm 7 1/4"  
K-Wire Dispenser  
wire length  
16 cmØ  
wires 1,0 / 1,2 /  
1,4 / 1,6 mm Ø  
length of  
dispenser 18,5 cm  
with white  
plastic cap

ZI-28-730-31  
Vickers  
18.5cm 7 1/4"  
K-Wire Dispenser  
wire length  
31 cmØ  
wires 1,8 / 2,0 /  
2,2 / 2,5 mm Ø  
length of  
dispenser 18,5 cm  
with white  
plastic cap

ZI-28-731-16  
Vickers  
34cm 12 1/4  
K-Wire Dispenser  
wire length  
16 cmØ  
wires 1,0 / 1,2 /  
1,4 / 1,6 mm Ø  
length of  
dispenser 34 cm  
with white  
plastic cap

ZI-28-731-31  
Vickers  
34cm 12 1/4  
K-Wire Dispenser  
wire length 31 cmØ  
wires 1,8 / 2,0 /  
2,2 / 2,5 mm Ø  
length of  
dispenser 34 cm  
with white  
plastic cap



ZI-28-732-08

18.5cm 7 1/4"

K-Wire Dispenser wire length

16 cmØ wires 0,8 mm Ø

length of dispenser with white plastic cap

ZI-28-732-10

18.5cm 7 1/4"

K-Wire Dispenser wire length

16 cmØ wires 1,0 mm Ø

length of dispenser with white plastic cap

ZI-28-732-12

18.5cm 7 1/4"

K-Wire Dispenser wire length

16 cmØ wires 1,2 mm Ø

length of dispenser with white plastic cap

ZI-28-732-14

18.5cm 7 1/4"

K-Wire Dispenser wire length

16 cmØ wires 1,4 mm Ø

length of dispenser with white plastic cap

ZI-28-732-15

18.5cm 7 1/4"

K-Wire Dispenser wire length

16 cmØ wires 1,5 mm Ø

length of dispenser with white plastic cap

ZI-28-732-16

18.5cm 7 1/4"

K-Wire Dispenser wire length

16 cmØ wires 1,6 mm Ø

length of dispenser with white plastic cap

ZI-28-732-18

18.5cm 7 1/4"

K-Wire Dispenser wire length

16 cmØ wires 1,8 mm Ø

length of dispenser with white plastic cap

ZI-28-732-20

18.5cm 7 1/4"

K-Wire Dispenser wire length

16 cmØ wires 2,0 mm Ø

length of dispenser with white plastic cap

ZI-28-732-22

18.5cm 7 1/4"

K-Wire Dispenser wire length

16 cmØ wires 2,2 mm Ø

length of dispenser with white plastic cap

ZI-28-732-25

18.5cm 7 1/4"

K-Wire Dispenser wire length

16 cmØ wires 2,5 mm Ø

length of dispenser with white plastic cap



ZI-28-734-08

33.5cm 13 1/4K-Wire Dispenser  
wire length 31 cm  $\emptyset$  wires 0,8 mm  $\emptyset$   
length of dispenser with white plastic cap

ZI-28-734-10

33.5cm 13 1/4K-Wire Dispenser  
wire length 31 cm  $\emptyset$  wires 1,0 mm  $\emptyset$   
length of dispenser with white plastic cap

ZI-28-734-12

33.5cm 13 1/4K-Wire Dispenser  
wire length 31 cm  $\emptyset$  wires 1,2 mm  $\emptyset$   
length of dispenser with white plastic cap

ZI-28-734-14

33.5cm 13 1/4K-Wire Dispenser  
wire length 31 cm  $\emptyset$  wires 1,4 mm  $\emptyset$   
length of dispenser with white plastic cap

ZI-28-734-15

33.5cm 13 1/4K-Wire Dispenser  
wire length 31 cm  $\emptyset$  wires 1,5 mm  $\emptyset$   
length of dispenser with white plastic cap

ZI-28-734-16

33.5cm 13 1/4K-Wire Dispenser  
wire length 31 cm  $\emptyset$  wires 1,6 mm  $\emptyset$   
length of dispenser with white plastic cap

ZI-28-734-18

33.5cm 13 1/4K-Wire Dispenser  
wire length 31 cm  $\emptyset$  wires 1,8 mm  $\emptyset$   
length of dispenser with white plastic cap

ZI-28-734-20

33.5cm 13 1/4K-Wire Dispenser  
wire length 31 cm  $\emptyset$  wires 2,0 mm  $\emptyset$   
length of dispenser with white plastic cap

ZI-28-734-22

33.5cm 13 1/4K-Wire Dispenser  
wire length 31 cm  $\emptyset$  wires 2,2 mm  $\emptyset$   
length of dispenser with white plastic cap

ZI-28-734-25

33.5cm 13 1/4K-Wire Dispenser  
wire length 31 cm  $\emptyset$  wires 2,5 mm  $\emptyset$   
length of dispenser with white plastic cap



**ZARYAB**  
I N S T R U M E N T S

*Products that saves life*

Hygiene  
Storage



ZI-28-805-14  
Mayo  
14cm 5 1/2"  
Safety Pin



ZI-28-808-14  
Mayo  
14cm 5 1/2"  
Safety Pin  
Safety Pins

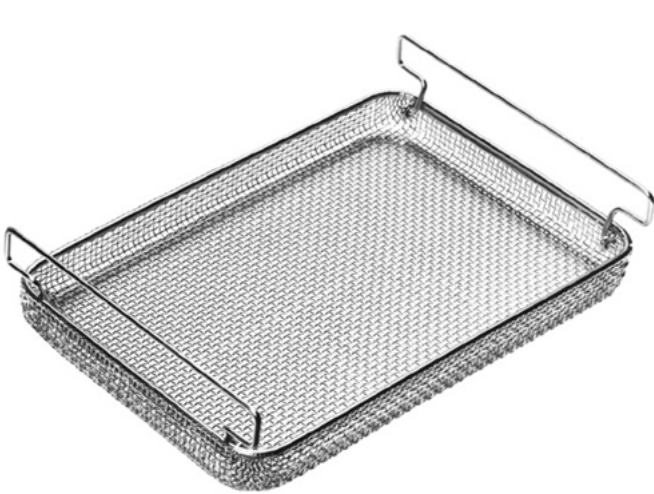

ZI-28-808-20  
Tray  
260 x 170 x 28 mm  
wire mesh

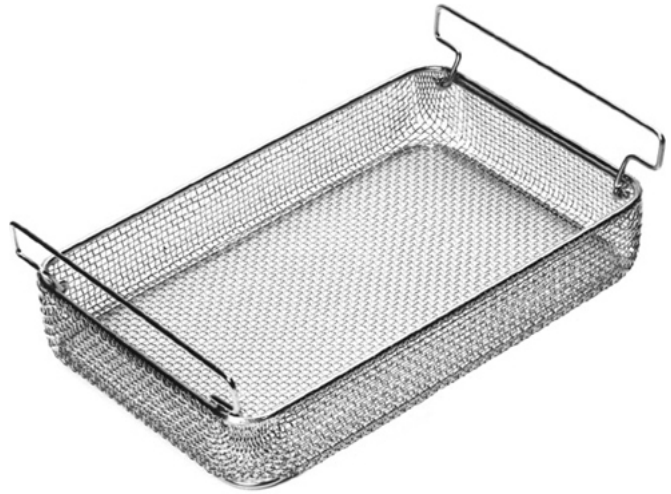

ZI-28-808-21  
Tray  
260 x 170 x 47 mm  
wire mesh

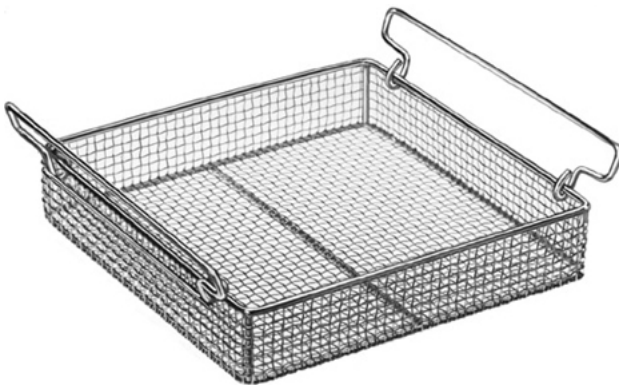

ZI-28-808-24  
Tray  
240 x 240 x 50 mm  
wire mesh

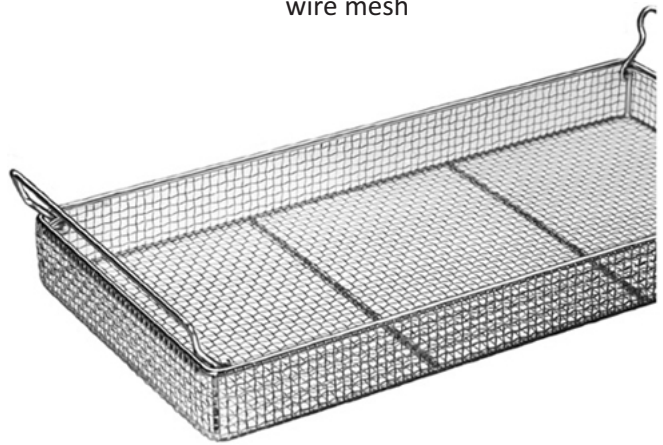

ZI-28-808-48  
Tray  
480 x 240 x 50 mm  
wire mesh

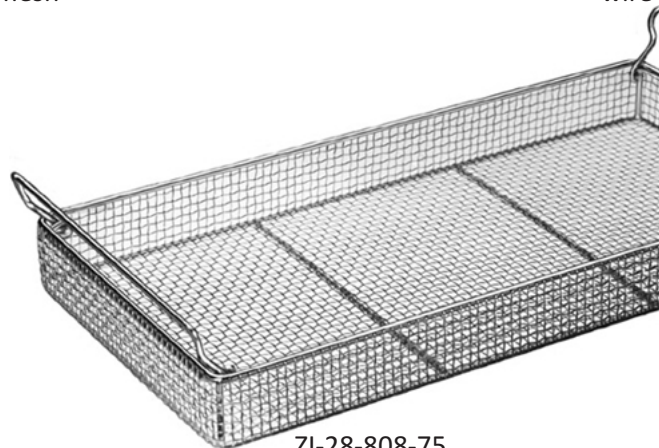

ZI-28-808-75  
Tray  
520 x 240 x 75 mm  
wire mesh



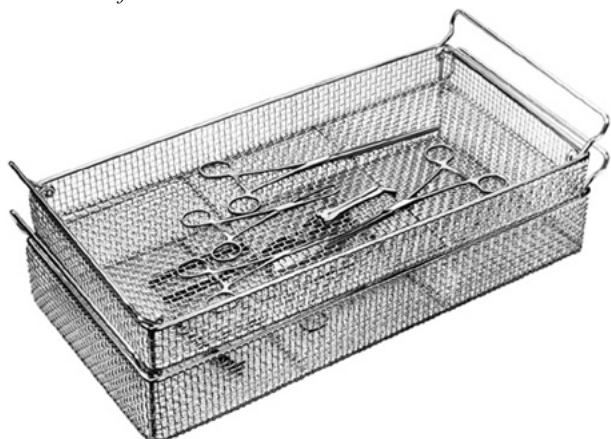

ZI-28-808-99  
Tray  
520 x 240 x 100 mm  
wire mesh



ZI-28-809-14  
Tray  
260 x 130 x 50 mm  
perforated steel sheet



ZI-28-809-15  
Tray  
280 x 130 x 50 mm  
for micro instruments  
with silicone inserts and lid  
perforated steel sheet



ZI-28-809-24  
Tray  
260 x 260 x 50 mm  
perforated steel sheet



ZI-28-809-25  
Tray  
260 x 260 x 50 mm  
for micro instruments with silicone inserts and lid perforated steel sheet



**ZARYAB**  
I N S T R U M E N T S

*Products that saves life*

## Hygiene Storage



ZI-28-809-48  
Tray  
480 x 260 x 50 mm  
perforated steel sheet



ZI-28-809-49  
Tray  
480 x 260 x 50 mm  
for micro instruments  
with silicone inserts and lid  
perforated steel sheet



ZI-28-809-50  
Tray  
520 x 260 x 50 mm  
perforated steel sheet



**ZARYAB**  
INSTRUMENTS

*Products that saves life*

## Hygiene Storage



ZI-28-890-15  
Sterilizing Basket  
600 x 300 x 130 mm

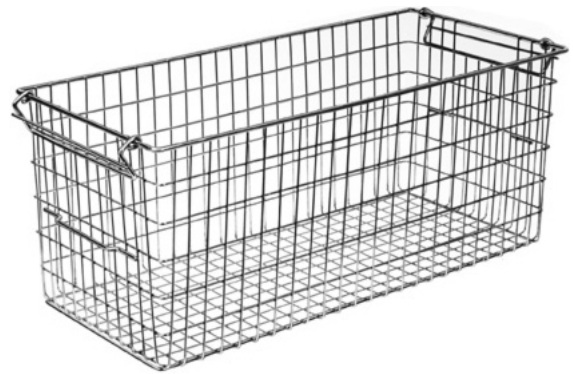

ZI-28-890-30  
Sterilizing Basket  
600 x 300 x 260 mm

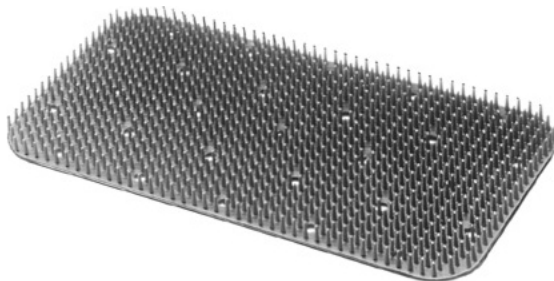

ZI-28-999-91  
Silicone Matfor container  
300 x 150 mm

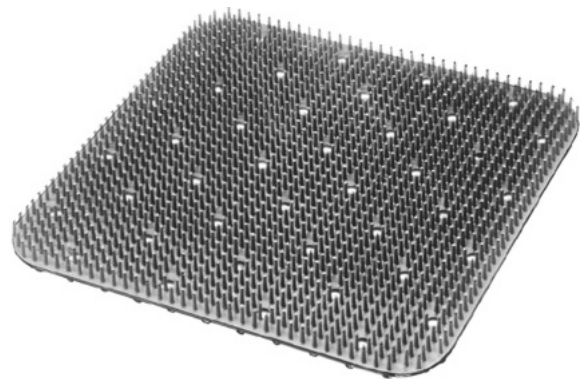

ZI-28-999-92  
Silicone Matfor container  
300 x 300 mm

ZI-55-999-93  
Silicone Matfor tray  
260 x 260 mm





*Products that saves life*

# ZARYAB

---

## I N S T R U M E N T S

 Harar, Wazirabad Road, Pir Sabz Rd, Pir Sabz, Sialkot-51310, Pakistan

 +92 52 3573775

 +92 52 3573776

 +92 333 8608580 , +92 333 3349600

 [info@zaryabinstruments.com](mailto:info@zaryabinstruments.com)

 [sales@zaryabinstruments.com](mailto:sales@zaryabinstruments.com)

 [www.zaryabinstruments.com](http://www.zaryabinstruments.com)