



Products that saves life

ZARYAB

INSTRUMENTS



CRANIO MAXILLO FACIAL SURGE

Catalogue





Cranio Maxillo Facial Surge



ZI-25-101-16
Obwegeser
21.5cm 8 1/2"
Soft Tissue Retractor
5 x 16 mm
bent upwards

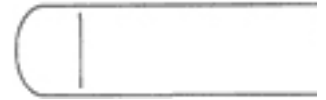

ZI-25-101-550
Obwegeser
23.5cm 9 1/4"
Soft Tissue Retractor
12 x 55 mm
bent upwards



ZI-25-101-25
Obwegeser
22.5cm 8 3/4"
Soft Tissue Retractor
7 x 25 mm
bent upwards



ZI-25-101-700
Obwegeser
24cm 9 1/2"
Soft Tissue Retractor
14 x 70 mm
bent upwards



ZI-25-101-35
Obwegeser
23cm 9"
Soft Tissue Retractor
10 x 35 mm
bent upwards



ZI-25-101-80
Obwegeser
24cm 9 1/2"
Soft Tissue Retractor
16 x 80 mm
bent upwards



ZI-25-101-42
Obwegeser
23cm 9"
Soft Tissue Retractor
10 x 42 mm
bent upwards



Cranio Maxillo Facial Surge



ZI-25-103-16
Obwegeser
21.5cm 8 1/2"
Soft Tissue Retractor
5 x 16 mm
bent downwards

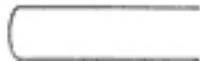

ZI-25-103-25
Obwegeser
22.5cm 8 3/4"
Soft Tissue Retractor
7 x 25 mm
bent downwards



ZI-25-103-35
Obwegeser
23cm 9"
Soft Tissue Retractor
10 x 35 mm
bent downwards

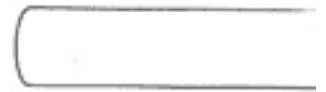

ZI-25-103-42
Obwegeser
23cm 9"
Soft Tissue Retractor
10 x 42 mm
bent downwards



ZI-25-103-55
Obwegeser
23.5cm 9 1/4"
Soft Tissue Retractor
12 x 55 mm
bent downwards



ZI-25-103-70
Obwegeser
24cm 9 1/2"
Soft Tissue Retractor
14 x 70 mm
bent downwards



ZI-25-103-80
Obwegeser
24cm 9 1/2"
Soft Tissue Retractor
16 x 80 mm
bent downwards



ZARYAB
I N S T R U M E N T S

Products that saves life

Cranio Maxillo Facial Surge



ZI-25-105-30
Obwegeser
21cm 8 1/4"
Mandibular Retractor
9/12 x 30 mm

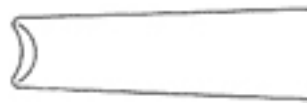

ZI-25-105-45
Obwegeser
21cm 8 1/4"
Mandibular Retractor
9/12 x 45 mm

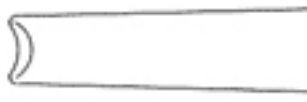

ZI-25-105-60
Obwegeser
21cm 8 1/4"
Mandibular Retractor
9/12 x 60 mm



Cranio Maxillo Facial Surge

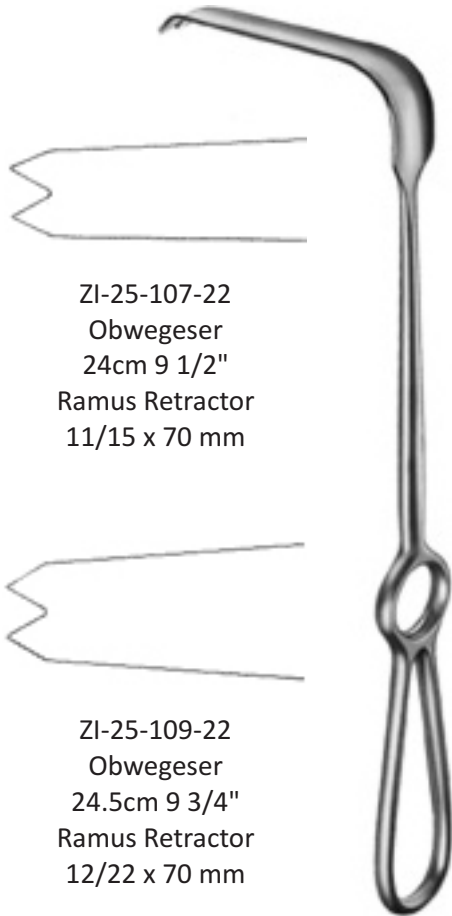

ZI-25-107-22
Obwegeser
24cm 9 1/2"
Ramus Retractor
11/15 x 70 mm



ZI-25-109-22
Obwegeser
24.5cm 9 3/4"
Ramus Retractor
12/22 x 70 mm

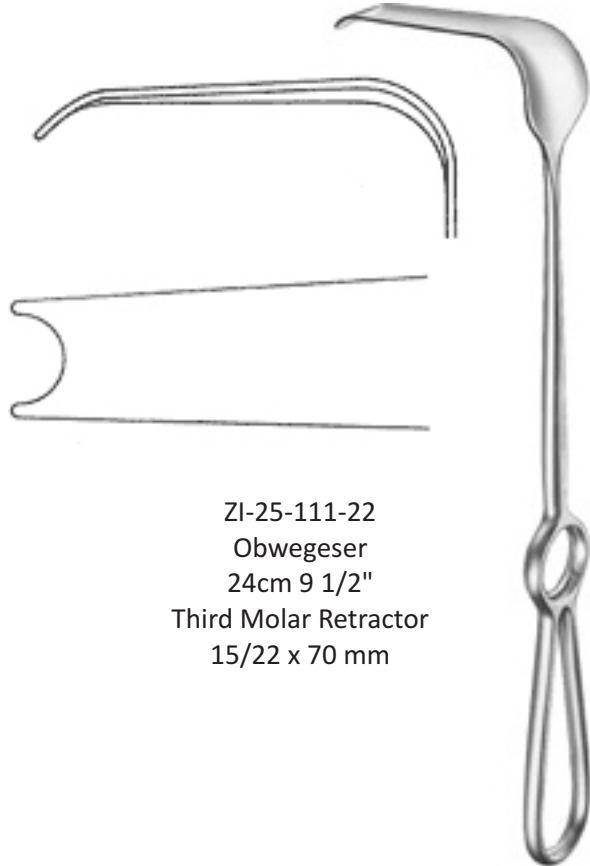

ZI-25-111-22
Obwegeser
24cm 9 1/2"
Third Molar Retractor
15/22 x 70 mm

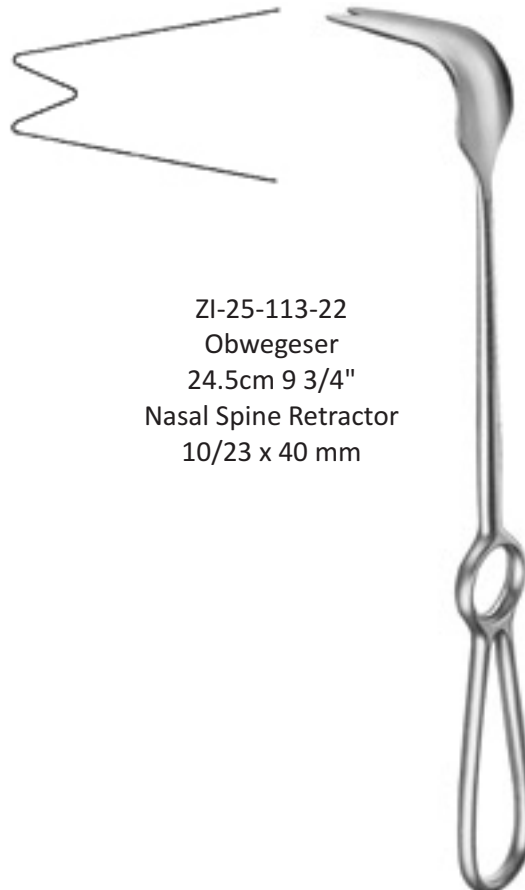

ZI-25-113-22
Obwegeser
24.5cm 9 3/4"
Nasal Spine Retractor
10/23 x 40 mm



Cranio Maxillo Facial Surge



ZI-25-115-01
Obwegeser
15cm 6"
Ramus Clamp
small pattern, right



ZI-25-115-02
Obwegeser
15cm 6"
Ramus Clamp
small pattern, left



ZI-25-117-01
Obwegeser
20cm 8"
Ramus Clamp
large pattern, right



ZI-25-117-02
Obwegeser
20cm 8"
Ramus Clamp
large pattern, left



Cranio Maxillo Facial Surge

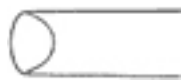

ZI-25-121-08
Obwegeser
16.5cm 6 1/2"
Channel Retractor
8 mm

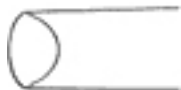

ZI-25-121-10
Obwegeser
16.5cm 6 1/2"
Channel Retractor
10 mm



ZI-25-125-15
Obwegeser
16cm 6 1/4"
Chin Holder
16,5 mm



Cranio Maxillo Facial Surge



ZI-25-130-06
Obwegeser
18cm 7"
Periosteal Elevator
6 mm
angled cutting



ZI-25-130-07
Obwegeser
18cm 7"
Periosteal Elevator
7 mm
angled cutting



ZI-25-130-09
Obwegeser
18cm 7"
Periosteal Elevator
9 mm
angled cutting



ZI-25-130-11
Obwegeser
18cm 7"
Periosteal Elevator
11 mm
angled cutting



ZI-25-132-06
Obwegeser
18cm 7"
Periosteal Elevator
6 mm
flat cutting



ZI-25-132-07
Obwegeser
18cm 7"
Periosteal Elevator
7 mm
flat cutting



ZI-25-132-09
Obwegeser
18cm 7"
Periosteal Elevator
9 mm
flat cutting



ZI-25-132-11
Obwegeser
18cm 7"
Periosteal Elevator
11 mm
flat cutting



ZARYAB
I N S T R U M E N T S

Products that saves life

Cranio Maxillo Facial Surge



ZI-25-135-21
Obwegeser
21cm 8 1/4"
Elevator
6 mm Elevator



ZI-25-137-21
Obwegeser
21cm 8 1/4"
Periosteal Elevator
6 mm Raspatory



ZI-25-140-01
Obwegeser
18cm 7"
Mandibular Inferior
Border Raspatory
10 mm angled to left



ZI-25-140-02
Obwegeser
18cm 7"
Mandibular Inferior
Border Raspatory
10 mm angled to right



ZARYAB

INSTRUMENTS

Products that saves life

Cranio Maxillo Facial Surge



ZI-25-150-01
Obwegeser
17.5cm 7"
Swallowtail
Raspatory 7,5 mm

ZI-25-150-02
Obwegeser
17.5cm 7"
Swallowtail
Raspatory 11 mm

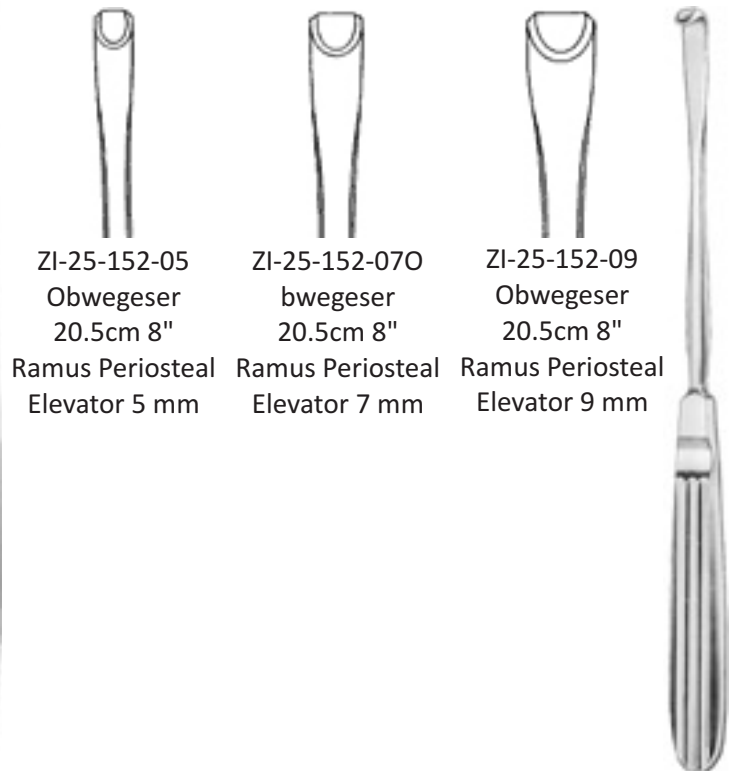

ZI-25-152-05
Obwegeser
20.5cm 8"
Ramus Periosteal
Elevator 5 mm

ZI-25-152-070
Obwegeser
20.5cm 8"
Ramus Periosteal
Elevator 7 mm

ZI-25-152-09
Obwegeser
20.5cm 8"
Ramus Periosteal
Elevator 9 mm



Cranio Maxillo Facial Surge



ZI-25-156-04
Obwegeser
18.5cm 7 1/4"
Septonasal Osteotome
4 mm graduated



ZI-25-156-06
Obwegeser
18.5cm 7 1/4"
Septonasal Osteotome
6 mm graduated



ZI-25-156-08
Obwegeser
18.5cm 7 1/4"
Septonasal Osteotome
8 mm graduated



ZI-25-160-08
Obwegeser
22cm 8 3/4"
Wedge Osteotome
8 mm



ZI-25-160-12
Obwegeser
22cm 8 3/4"
Wedge Osteotome
12 mm



ZI-25-160-16
Obwegeser
22cm 8 3/4"
Wedge Osteotome
16 mm





Cranio Maxillo Facial Surge



Model	Obwegeser	Blade Osteotome
ZI-25-162-08	22cm 8 3/4"	8 mm
ZI-25-162-12	22cm 8 3/4"	12 mm
ZI-25-162-16	22cm 8 3/4"	16 mm
ZI-25-162-20	22cm 8 3/4"	20 mm

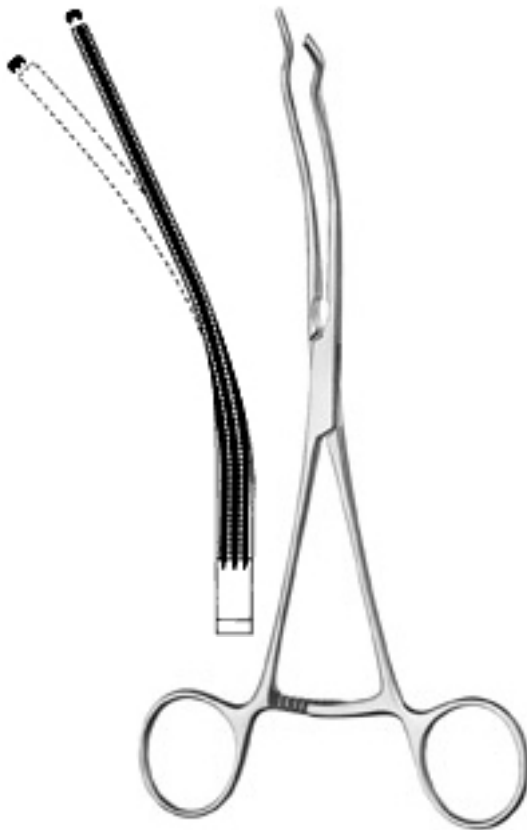

ZI-25-163-01
Obwegeser
21cm 8 1/4"
Fragment Adapting Forceps
jaw length 80 mm left

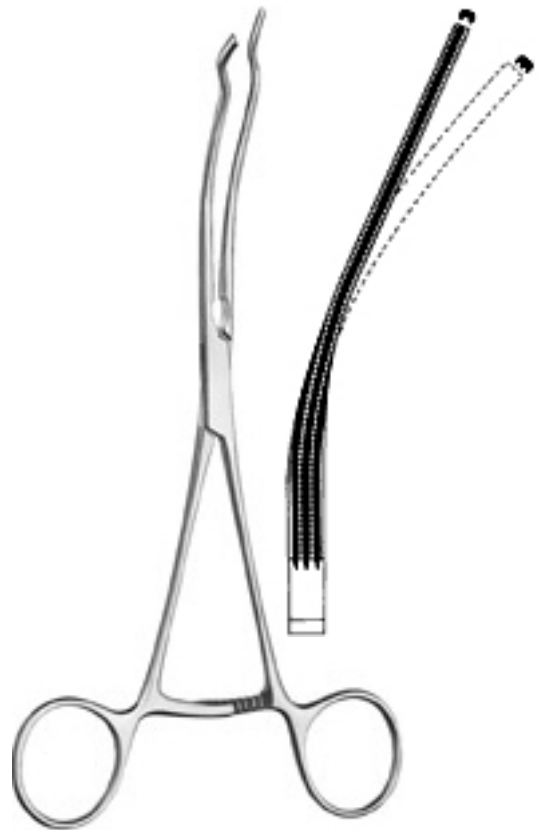

ZI-25-163-02
Obwegeser
21cm 8 1/4"
Fragment Adapting Forceps
jaw length 80 mm right



Cranio Maxillo Facial Surge



ZI-25-166-08
Obwegeser
23.5cm 9 1/4"
Tuberosity Osteotome
8 mm



ZI-25-166-11
Obwegeser
23.5cm 9 1/4"
Tuberosity Osteotome
11 mm



ZI-25-167-08
Obwegeser
21cm 8 1/4"
Osteotome
8 mm elastic blade



ZI-25-167-11
Obwegeser
21cm 8 1/4"
Osteotome
11 mm elastic blade



Cranio Maxillo Facial Surge



ZI-25-168-03
Obwegeser
15.5cm 6"
Osteotome for Alveolar
Process 3 mm



ZI-25-168-04
Obwegeser
15.5cm 6"
Osteotome for Alveolar
Process 4 mm



ZI-25-168-06
Obwegeser
15.5cm 6"
Osteotome for Alveolar
Process 6,5 mm

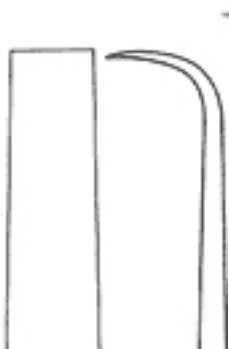

ZI-25-170-23
Obwegeser
23cm 9"
Maxillary Mobilizer
12 mm



ZI-25-175-15
Obwegeser
15cm 6"
Maxillary Awl



ZI-25-175-17
Obwegeser
17.5cm 7"
Maxillary Awl





ZARYAB
I N S T R U M E N T S

Products that saves life

Cranio Maxillo Facial Surge



ZI-25-177-24
Obwegeser
24cm 9 1/2"
Zygomatic Arch Awl



ZI-25-190-11
Obwegeser
12cm 4 3/4"
Wire Cutter



ZARYAB
I N S T R U M E N T S

Products that saves life

Cranio Maxillo Facial Surge



ZI-25-220-01
Obwegeser
17cm 6 3/4"
Bone Contouring
Forceps jaw
12 x 30 mm
convex / concave



ZI-25-220-02
Obwegeser
17.5cm 7"
Bone Contouring
Forceps jaw
13,5 x 30 mm
concave / convex



ZI-25-220-03
Obwegeser
17.5cm 7"
Bone Contouring
Forceps jaw
13,5 x 30 mm
flat / flat



Cranio Maxillo Facial Surge



ZI-25-250-19
Tessier
19cm 7 1/2"
Skin Hooklet sharp

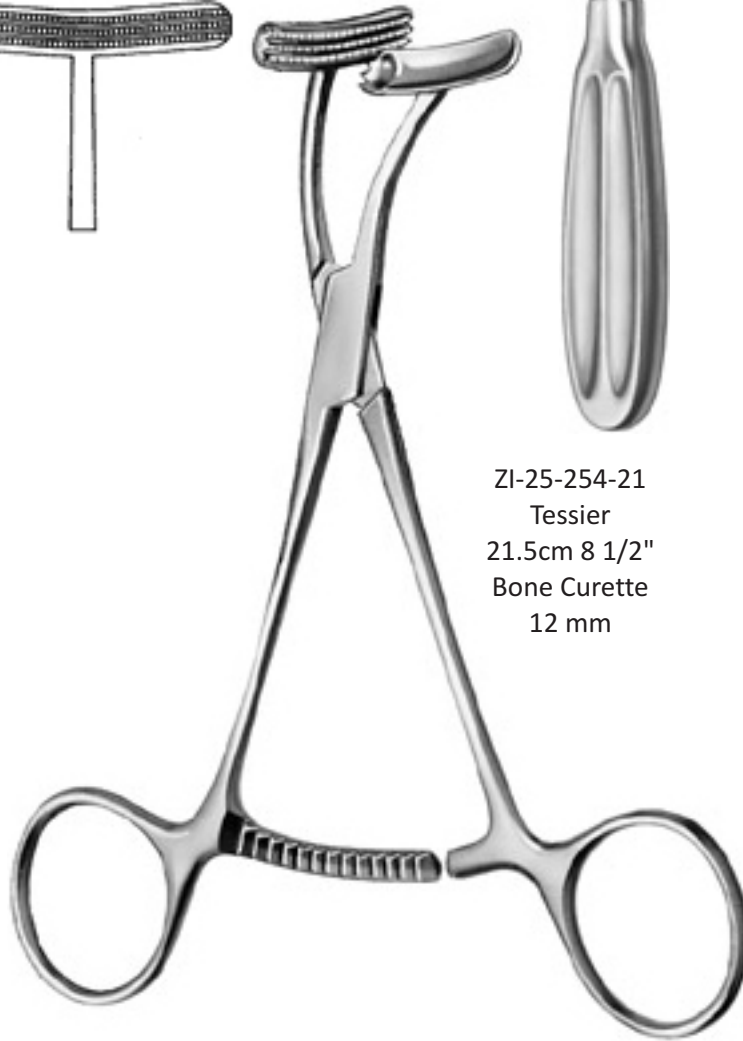
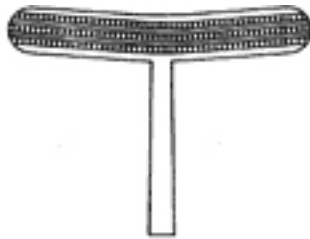

ZI-25-252-13
Tessier
13cm 5"
Scalp Clamp



ZI-25-254-21
Tessier
21.5cm 8 1/2"
Bone Curette
12 mm



ZI-25-256-19
Tessier
19.5cm 7 3/4"
Curette Sharpener
Curette Sharpener



ZARYAB
INSTRUMENTS

Products that saves life

Cranio Maxillo Facial Surge

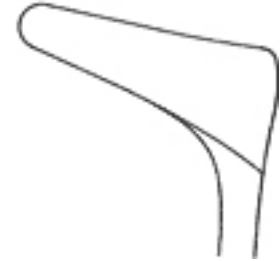

ZI-25-261-30
Tessier
13.5cm 5 1/4"
Nasal Speculum
blades 36 mm
black chromium-plated



ZI-25-261-45
Tessier
14cm 5 1/2"
Nasal Speculum
blades 45 mm
black chromium-plated

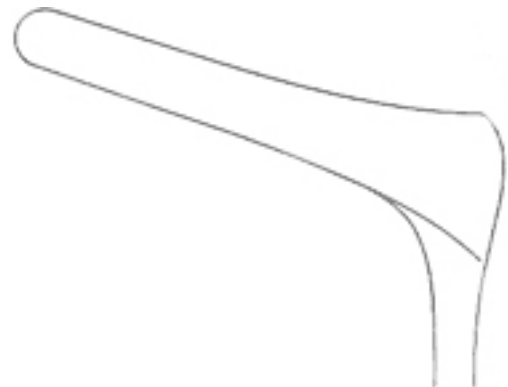

ZI-25-261-70
Tessier
14.5cm 5 3/4"
Nasal Speculum
blades 70 mm
black chromium-plated



ZI-25-258-22
Tessier
21.5cm 8 1/2"
Bone Curette 6 mm





Cranio Maxillo Facial Surge

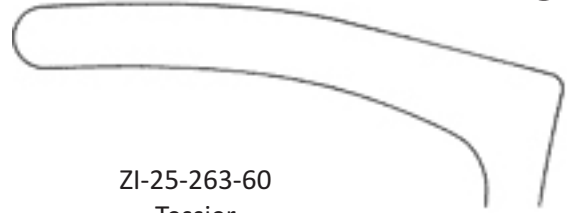

ZI-25-263-60
Tessier
17cm 6 3/4"
Nasal Speculum
blades 70 x 8,5 mm
for adults for dilation,
black chromiun-plated

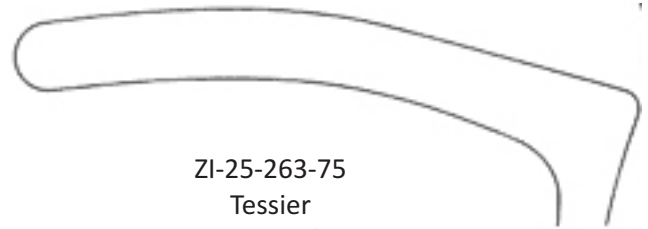

ZI-25-263-75
Tessier
17cm 6 3/4"
Nasal Speculum
blades 80 x 8,5 mm
for adults for dilation,
black chromiun-plated

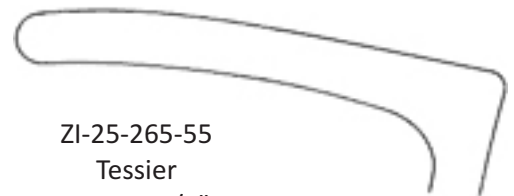

ZI-25-265-55
Tessier
17cm 6 3/4"
Nasal Speculum
blades 60 x 7,0 mm
for children for dilation,
black chromiun-plated

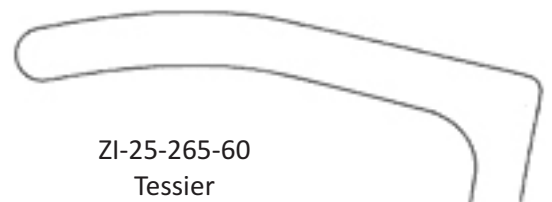

ZI-25-265-60
Tessier
17cm 6 3/4"
Nasal Speculum
blades 70 x 7,0 mm
for children for dilation,
black chromiun-plated



Cranio Maxillo Facial Surge



ZI-25-270-02
Tessier
16cm 6 1/4"
Osteotome
2 mm



ZI-25-270-03
Tessier
16cm 6 1/4"
Osteotome
3 mm



ZI-25-270-05
Tessier
16cm 6 1/4"
Osteotome
5 mm



ZI-25-270-07
Tessier
16cm 6 1/4"
Osteotome
7 mm



ZI-25-270-10
Tessier
16cm 6 1/4"
Osteotome
10 mm



ZI-25-270-14
Tessier
16cm 6 1/4"
Osteotome
14 mm



ZI-25-270-16
Tessier
16cm 6 1/4"
Osteotome
16 mm



ZI-25-271-05
Tessier
16cm 6 1/4"
Osteotome
5 mm



ZI-25-271-07
Tessier
16cm 6 1/4"
Osteotome
7 mm



ZI-25-271-10
Tessier
16cm 6 1/4"
Osteotome
10 mm



ZARYAB
I N S T R U M E N T S

Products that saves life

Cranio Maxillo Facial Surge

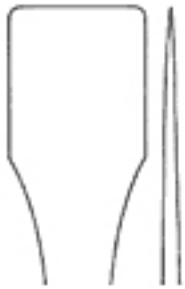

ZI-25-272-18
Tessier
16cm 6 1/4"
Osteotome
18 mm



ZI-25-273-10
Tessier
18cm 7"
Osteotome
10 mm



Cranio Maxillo Facial Surge



ZI-25-274-10
Tessier
20cm 7 3/4"
Osteotome
10 mm
for taking grafts
from ilium and tibia



ZI-25-274-15
Tessier
20cm 7 3/4"
Osteotome
15 mm
for taking grafts
from ilium and tibia

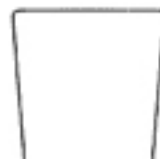

ZI-25-274-20
Tessier
20cm 7 3/4"
Osteotome
20 mm
for taking grafts
from ilium and tibia



ZI-25-274-30
Tessier
20cm 7 3/4"
Osteotome
30 mm
for taking grafts
from ilium and tibia



ZI-25-275-10
Tessier
20cm 7 3/4"
Osteotome
10 mm for taking grafts
from ilium and tibia



ZI-25-275-15
Tessier
20cm 7 3/4"
Osteotome
15 mm for taking grafts
from ilium and tibia



ZI-25-276-10
Tessier
16cm 6 1/4"
Osteotome
10 mm
for taking grafts
from ilium and calva



ZI-25-276-15
Tessier
16cm 6 1/4"
Osteotome
15 mm
for taking grafts
from ilium and calva



ZI-25-277-10
Tessier
16cm 6 1/4"
Osteotome
10 mm
for taking grafts
from the calva

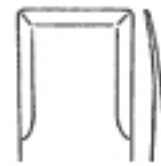

ZI-25-277-15
Tessier
16cm 6 1/4"
Osteotome
15 mm
for taking grafts
from the calva





Cranio Maxillo Facial Surge



ZI-25-285-20
Tessier
20.5cm 8"
Thoracic Retractor
90 x 22 mm
black chromium-plated



ZI-25-285-28
Tessier
28cm 11"
Thoracic Retractor
120 x 28 mm
black chromium-plated



ZI-25-287-01
Tessier
16cm 6 1/4"
Iliac Crest Retractor
36 x 50 mm black
chromium-plated

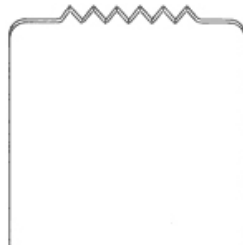

ZI-25-287-02
Tessier
16cm 6 1/4"
Iliac Crest Retractor
52 x 50 mm black
chromium-plated

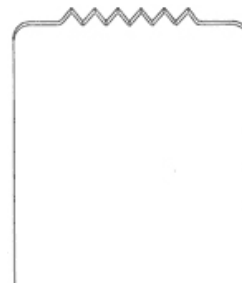

ZI-25-287-03
Tessier
16cm 6 1/4"
Iliac Crest Retractor
59 x 50 mm black
chromium-plated



ZI-25-287-04
Tessier
16cm 6 1/4"
Iliac Crest Retractor
66 x 50 mm black
chromium-plated



Cranio Maxillo Facial Surge



ZI-25-291-15
Tessier
16.5cm 6 1/2"
Bone Holding Forceps
5 mm



ZI-25-293-19
Tessier
18cm 7"
Bone Holding Forceps
5 mm

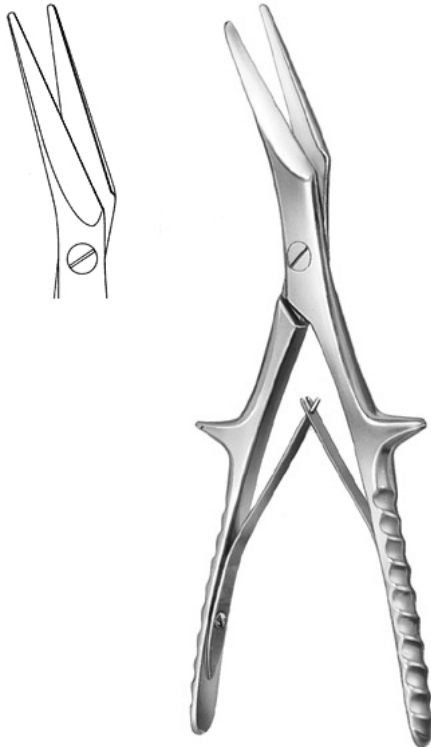

ZI-25-297-19
Tessier
19.5cm 7 3/4"
Bone Cutting Forceps
1 serrated cutting edge



ZI-25-299-19
Tessier
19cm 7 1/2"
Bone Cutting Forceps
1 serrated cutting edge



ZARYAB
I N S T R U M E N T S

Products that saves life

Cranio Maxillo Facial Surge



ZI-25-300-20
Tessier
20.5cm 8"
Bone Cutting Forceps
slim pattern



ZI-25-301-21
Tessier
21.5cm 8 1/2"
Bone Cutting Forceps

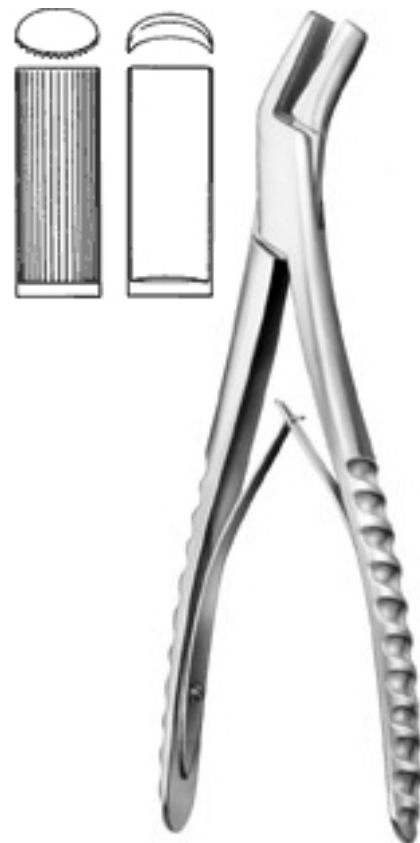

ZI-25-303-22
Tessier
22cm 8 3/4"
Bone Contouring
Forceps
11 mm
convex / concave
Bone Contouring Forceps



ZARYAB
I N S T R U M E N T S

Products that saves life

Cranio Maxillo Facial Surge



ZI-25-307-01
Tessier
20.5cm 8"
Iliac Crest Awl



ZI-25-307-02
Tessier
21cm 8 1/4"
Iliac Crest Awl



ZI-25-307-03
Tessier
21.5cm 8 1/2"
Iliac Crest Awl



Cranio Maxillo Facial Surge



ZI-25-311-01
Tessier
18.5cm 7 1/4"
Periosteal Elevator
6 mm 30°



ZI-25-311-02
Tessier
18cm 7"
Periosteal Elevator
6 mm 60°



ZI-25-313-01
Tessier
20.5cm 8"
Periosteal Elevator
12 mm



ZI-25-313-02
Tessier
20.5cm 8"
Periosteal Elevator
15 mm





ZARYAB
INSTRUMENTS

Products that saves life

Cranio Maxillo Facial Surge



ZI-25-316-21
Tessier
21cm 8 1/4"
Awl
2,5 mm Ø



ZI-25-318-16
Tessier
16.5cm 6 1/2"
Awl
4,5 mm Ø



ZI-25-320-14
Tessier
14cm 5 1/2"
Trocar
2,5 mm Ø
Trocar



Cranio Maxillo Facial Surge



ZI-25-330-01
Tessier
22cm 8 3/4"
Spatula
10 - 12 mm
conical black
chromium-plated



ZI-25-330-02
Tessier
22cm 8 3/4"
Spatula
15 - 17 mm
conical black
chromium-plated



ZI-25-330-03
Tessier
22cm 8 3/4"
Spatula
20 - 22 mm
conical black
chromium-plated



Cranio Maxillo Facial Surge



ZI-25-331-01
Tessier
15cm 6"
Soft Tissue Retractor
20 x 7 / 30 x 10 mm
black chromium-plated



ZI-25-331-02
Tessier
15cm 6"
Soft Tissue Retractor
20 x 12 / 30 x 16 mm
black chromium-plated



ZI-25-331-03
Tessier
15.5cm 6"
Soft Tissue Retractor
30 x 12 / 35 x 16 mm
black chromium-plated



ZI-25-331-04
Tessier
15.5cm 6"
Soft Tissue Retractor
35 x 12 / 45 x 16 mm
black chromium-plated





ZARYAB
I N S T R U M E N T S

Products that saves life

Cranio Maxillo Facial Surge



ZI-25-333-03

Tessier

14.5cm 5 3/4"

Soft Tissue Retractor
30 x 12 / 35 x 16 mm
black chromium-plated



ZI-25-333-04

Tessier

15cm 6"

Soft Tissue Retractor
35 x 12 / 45 x 16 mm
black chromium-plated



ZI-25-333-05

Tessier

16cm 6 1/4"

Soft Tissue Retractor
50 x 12 / 70 x 16 mm
black chromium-plated

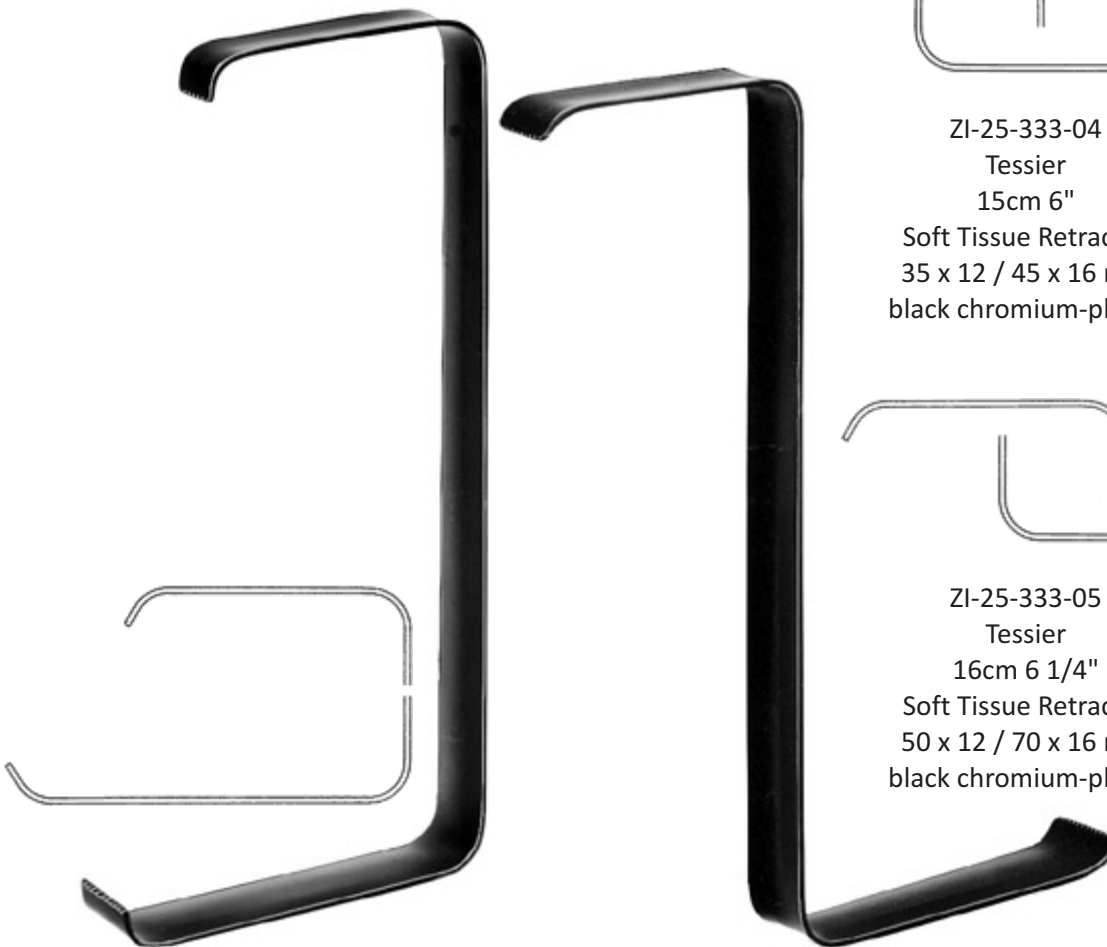

ZI-25-331-05

Tessier

15.5cm 6"

Soft Tissue Retractor
50 x 12 / 70 x 16 mm
black chromium-plated



Cranio Maxillo Facial Surge



ZI-25-335-01
Tessier
12.5cm 5"
Soft Tissue Retractor
Fig. 1 8 mm
black chromium-plated



ZI-25-335-02
Tessier
12.5cm 5"
Soft Tissue Retractor
Fig. 210 mm
black chromium-plated



ZI-25-335-03
Tessier
12.5cm 5"
Soft Tissue Retractor
Fig. 37 mm
black chromium-plated



ZI-25-335-04
Tessier
12.5cm 5"
Soft Tissue Retractor
Fig. 410 mm
black chromium-plated



ZI-25-335-05
Tessier
12.5cm 5"
Soft Tissue Retractor
Fig. 58 mm
black chromium-plated



ZI-25-335-06
Tessier
12.5cm 5"
Soft Tissue Retractor
Fig. 612 mm
black chromium-plated



Cranio Maxillo Facial Surge



ZI-25-336-10
Tessier
14.5cm 5 3/4"
Saddle Hooklet
10 mm
black chromium-plated



ZI-25-336-17
Tessier
15cm 6"
Saddle Hooklet
17,5 mm
black chromium-plated



ZI-25-336-20
Tessier
15.5cm 6"
Saddle Hooklet
20 mm
black chromium-plated



ZI-25-340-18
Tessier
18.5cm 7 1/4"
Septonasal Osteotome
Septonasal Osteotome



ZI-25-341-18
Tessier
18cm 7"
Osteotome
10 mm



ZI-25-343-06
Tessier
16.5cm 6 1/2"
Retromaxillary Chisel
6 mm
Retromaxillary Chisel



ZI-25-343-09
Tessier
16.5cm 6 1/2"
Retromaxillary Chisel
9 mm
Retromaxillary Chisels



ZARYAB
INSTRUMENTS

Products that saves life

Cranio Maxillo Facial Surge

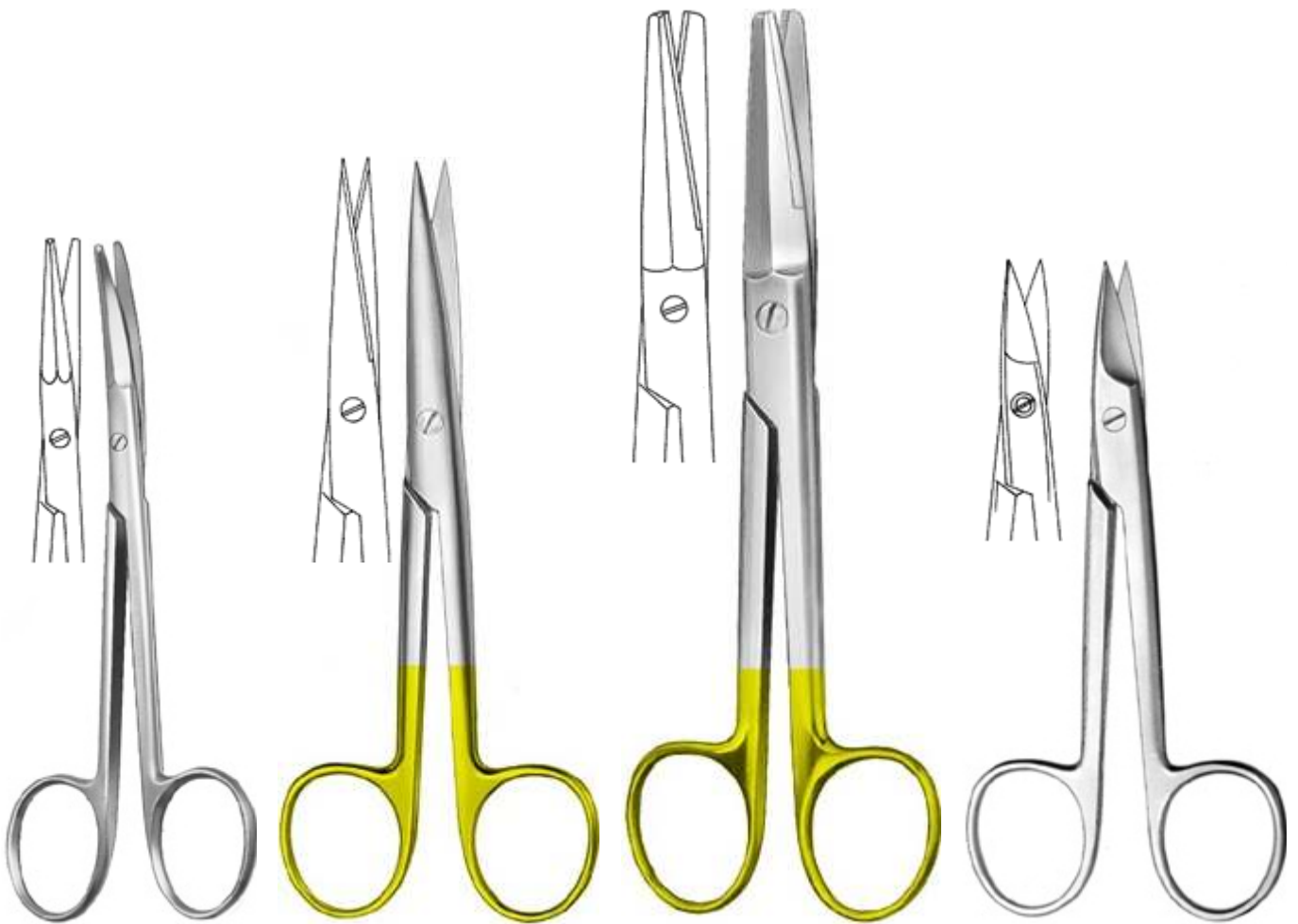

ZI-25-351-13

Tessier

13cm 5"

Undermining Scissors
Undermining Scissors

ZI-25-352-14

Tessier

14.5cm 5 3/4"

Dissecting Scissors

ZI-25-354-16

Tessier

16.5cm 6 1/2"

Dissecting Scissors

ZI-25-356-16

Tessier

12cm 4 3/4"

Wire Cutting Scissors





Cranio Maxillo Facial Surge

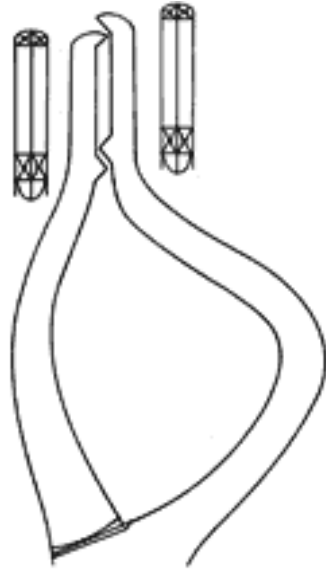

ZI-25-360-01
Tessier
22cm 8 3/4"
Disimpaction Forceps
left for children

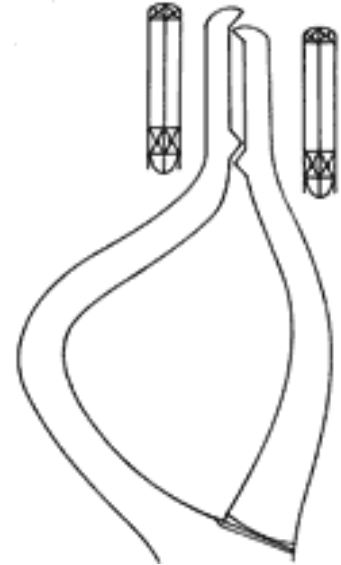

ZI-25-360-02
Tessier
22cm 8 3/4"
Disimpaction Forceps
right for children

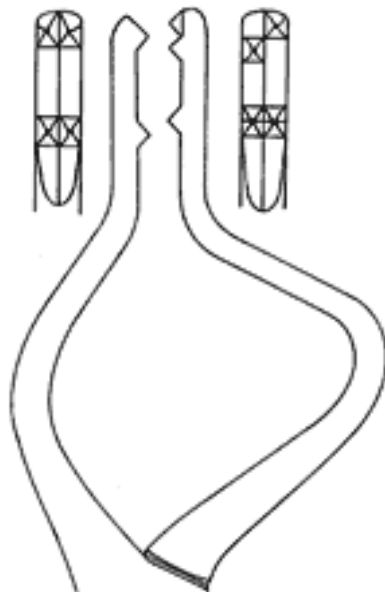

ZI-25-362-01
Tessier
23cm 9"
Disimpaction Forceps
left for adults

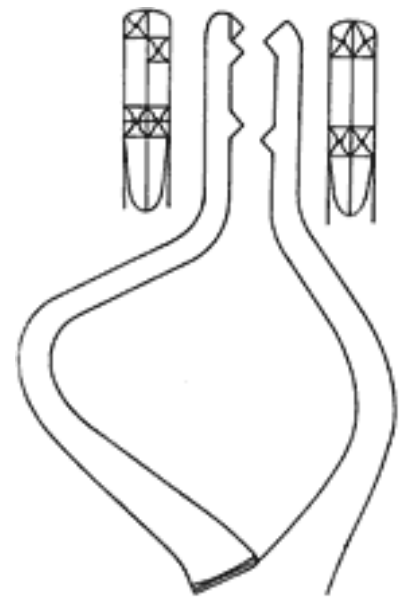

ZI-25-362-02
Tessier
23cm 9"
Disimpaction Forceps
right for adults



ZARYAB
INSTRUMENTS

Products that saves life

Cranio Maxillo Facial Surge

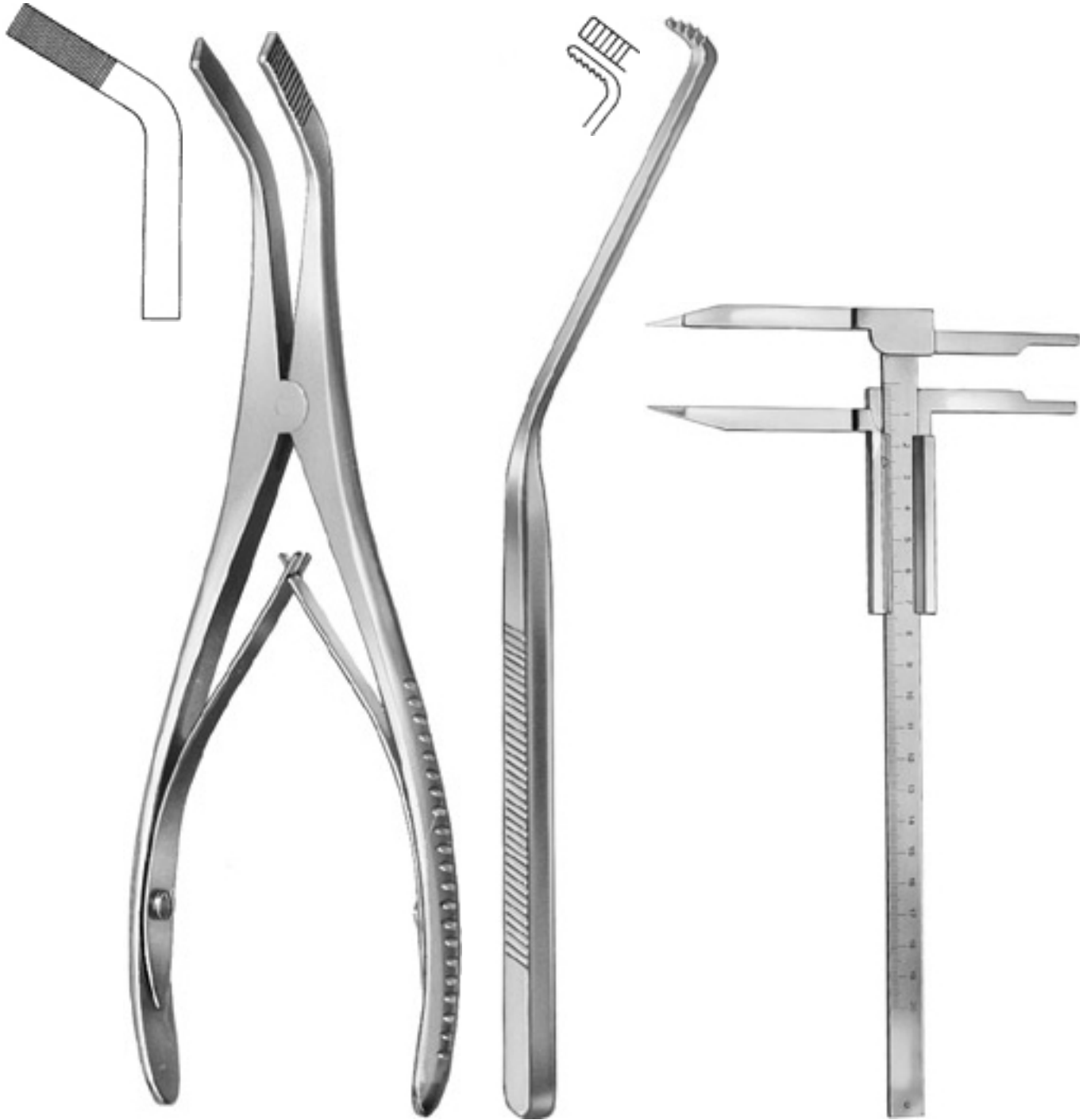

ZI-25-376-18
Tessier
17.5cm 7"
Spreading Forceps
7 mm
Spreading Forceps

ZI-25-371-18
Tessier
18.5cm 7 1/4"
Bone Hook
black chromium-plated

ZI-25-370-26
Tessier
26cm 10 1/4"
Calipermeasuring
range up to 200 mm



ZARYAB
I N S T R U M E N T S

Products that saves life

Cranio Maxillo Facial Surge



ZI-25-380-01
Tessier
15cm 6"
Mobilizing Retractor
9 mm
right

ZI-25-380-02
Tessier
15cm 6"
Mobilizing Retractor
9 mm
left



ZARYAB

I N S T R U M E N T S

Products that saves life

Cranio Maxillo Facial Surge



ZI-25-400-07
Marchac
15.5cm 6"
Periosteal Elevator
7,5 mm



ZI-25-400-12
Marchac
15.5cm 6"
Periosteal Elevator
12 mm



ZI-25-402-02
Marchac
17cm 6 3/4"
Periosteal
Elevator
2 mm



ZI-25-402-03
Marchac
17cm 6 3/4"
Periosteal
Elevator
3,5 mm



ZI-25-402-05
Marchac
17cm 6 3/4"
Periosteal
Elevator
5 mm





Cranio Maxillo Facial Surge



ZI-25-405-00
Marchac
Frontal Template
for infants
Frontal Templates

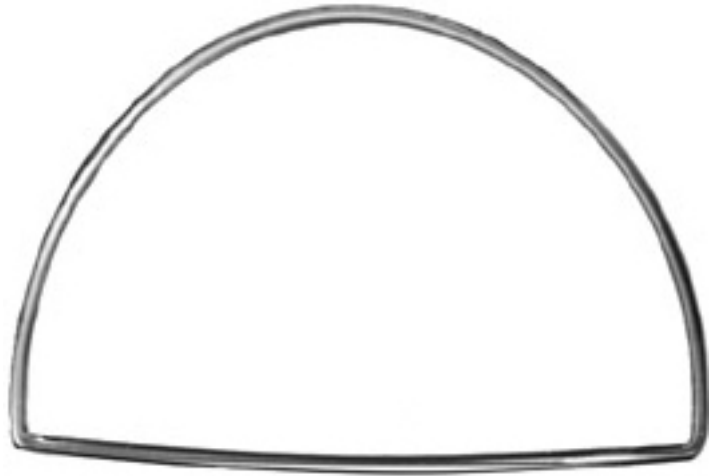

ZI-25-405-01
Marchac
Frontal Template
for children and adults
Frontal Templates



ZI-25-405-15
Marchac
16cm 6 1/4"
Supraorbital Template
1,9 mm Ø
Supraorbital Template



ZI-25-408-18
Marchac
18cm 7"
Dura Protector graduated



Cranio Maxillo Facial Surge



ZI-25-409-01
Marchac
13cm 5"
Dura Protector



ZI-25-409-02
Marchac
13.5cm 5 1/4"
Dura Protector

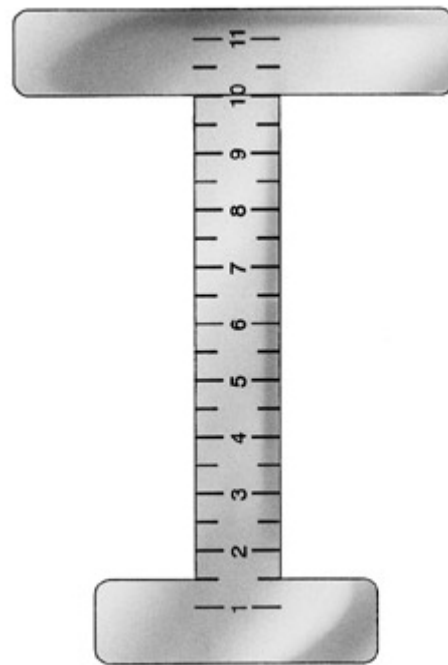

ZI-25-410-11
Marchac
11cm 4 1/4"
Dura Protector graduated



ZI-25-416-15
Marchac
16cm 6 1/4"
File for smoothing
rough
edges of damaged
dura protectors



ZARYAB
INSTRUMENTS

Products that saves life

Cranio Maxillo Facial Surge



ZI-25-420-00
Marchac
Caliper measuring range
80 mm

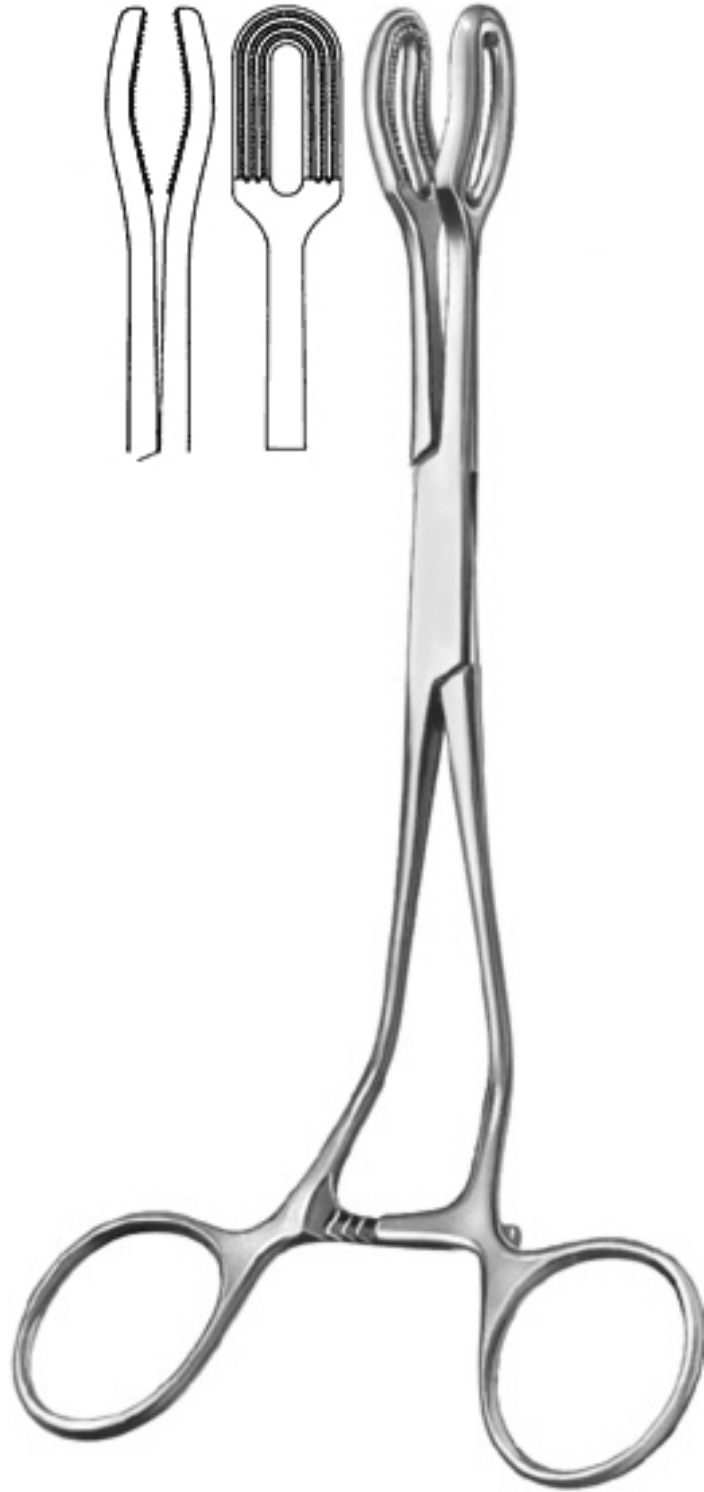

ZI-25-425-17
Marchac
17cm 6 3/4"
Bone Holding Forceps angled



ZARYAB
INSTRUMENTS

Products that saves life

Cranio Maxillo Facial Surge



ZI-26-440-04
Marchac
18.5cm 7 1/4"
Osteotome 4 mm



ZI-26-440-06
Marchac
18.5cm 7 1/4"
Osteotome 6 mm



ZI-26-440-08
Marchac
18.5cm 7 1/4"
Osteotome 8 mm



ZI-26-430-19
Marchac
19cm 7 1/2"
Suction Dissector

ZI-26-441-06
Marchac
18.5cm 7 1/4"
Osteotome
6 mm curved



ZARYAB
I N S T R U M E N T S

Products that saves life

Cranio Maxillo Facial Surge



ZI-26-446-19
Marchac
19cm 7 1/2"
Bone Hook sharp



ZI-26-450-17
Marchac
17cm 6 3/4"
Bone Expander
Spreading Forceps



ZI-26-453-18
Marchac
18cm 7"
Cranial Rongeur



Cranio Maxillo Facial Surge

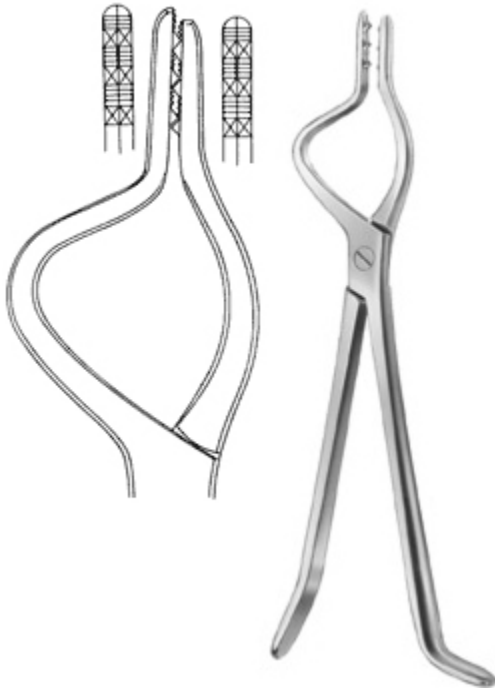

ZI-26-460-23
Marchac
23cm 9"
Disimpaction Forceps
for children



ZI-26-465-18
Marchac
18cm 7"
Bone Contouring Forceps
convex / concave
for children 6,5 mm



ZI-26-471-18
Marchac
18cm 7"
Bone Contouring Forceps
convex / concave for children
11 mm



ZI-26-480-21
Marchac
21.5cm 8 1/2"
Dura Protector / Wire Catcher





Products that saves life

ZARYAB

I N S T R U M E N T S

 Harar, Wazirabad Road, Pir Sabz Rd, Pir Sabz, Sialkot-51310, Pakistan

 +92 52 3573775

 +92 52 3573776

 +92 333 8608580 , +92 333 3349600

 info@zaryabinstruments.com

 sales@zaryabinstruments.com

 www.zaryabinstruments.com