

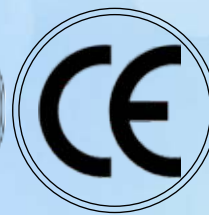

Products that saves life

ZARYAB

INSTRUMENTS



ORAL MAXILLO FACIAL SURGE

Catalogue





ZARYAB
INSTRUMENTS

Products that saves life

Oral Maxillo Facial Surge

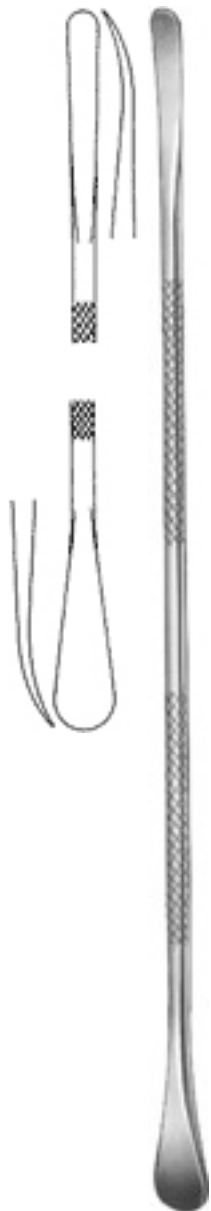

ZI-24-011-16
Terry
17cm 6 3/4"
Elevator
5,0 / 8,0 mm
for elevation of
alveolar flaps



ZI-24-012-16
Terry
11cm 4 1/4"
Graft Packer
Graft Packer

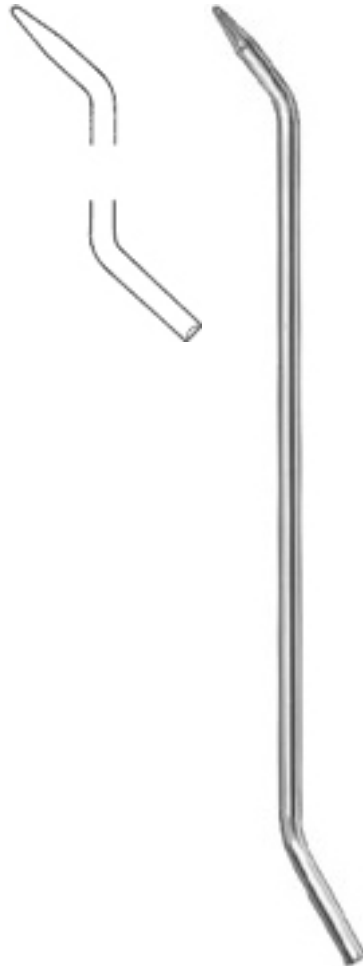

ZI-24-013-13
13cm 5"
Graft Packer
Graft Packer



ZI-24-014-00
Terry
18cm 7"
Periosteal
Elevator
3,0 / 7,0 mm
for subperio
steal tunnels



ZI-24-015-01
18cm 7"
Sinus Lift Curette
2,6 / 2,6 mm



ZARYAB
I N S T R U M E N T S

Products that saves life

Oral Maxillo Facial Surge



ZI-24-015-02
17.5cm 7"
Sinus Lift Curette
2,6 / 2,6 mm



ZI-24-015-03
18cm 7"
Sinus Lift Curette
4,1 / 4,1 mm



ZI-24-015-04
18.5cm 7 1/4"
Sinus Lift Curette
4,1 / 4,1 mm

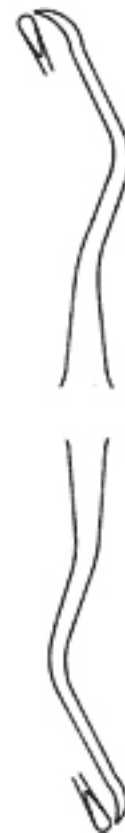

ZI-24-015-05
18.5cm 7 1/4"
Sinus Lift Curette
6,7 / 6,7 mm





ZARYAB
I N S T R U M E N T S

Products that saves life

Oral Maxillo Facial Surge



ZI-24-015-06
19cm 7 1/2"
Sinus Lift Curette
6,7 / 6,7 mm



ZI-24-015-07
16cm 6 1/4"
Sinus Lift Curette
2,8 / 6,2 mm

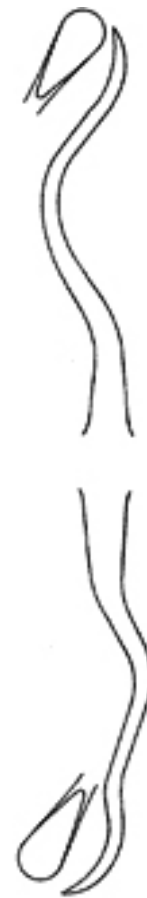

ZI-24-015-08
16cm 6 1/4"
Sinus Lift Curette
2,8 / 6,2 mm





ZARYAB
I N S T R U M E N T S

Products that saves life

Oral Maxillo Facial Surge



ZI-24-015-09
15cm 6"

Sinus Lift Curette
3,1 / 3,1 mm

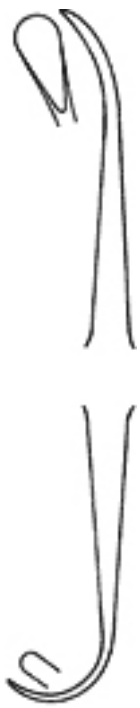

ZI-24-015-10
17cm 6 3/4"

Sinus Lift Curette
5,6 / 5,6 mm



ZI-24-016-01
16.5cm 6 1/2"
Sinus Lift Curette
Fig. 1

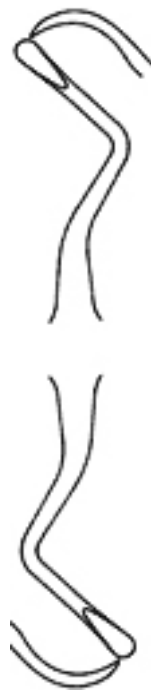

ZI-24-016-02
16.5cm 6 1/2"
Sinus Lift Curette
Fig. 2





ZARYAB
INSTRUMENTS

Products that saves life

Oral Maxillo Facial Surge

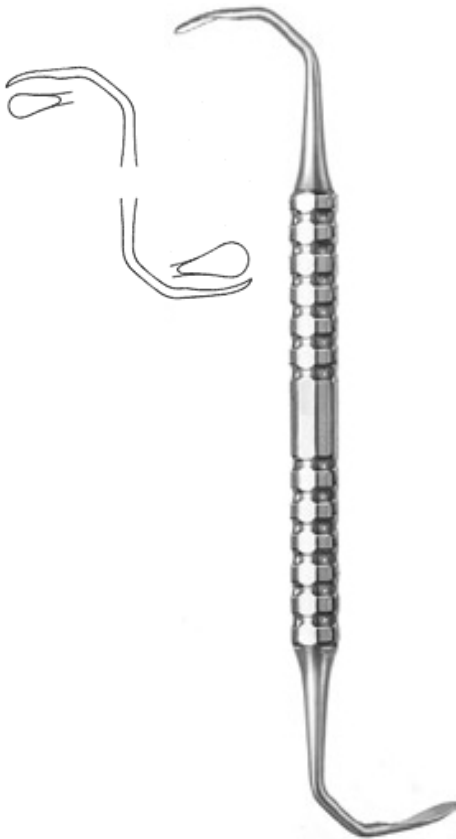

ZI-24-016-03
14cm 5 1/2"
Sinus Lift Curette
Fig. 3

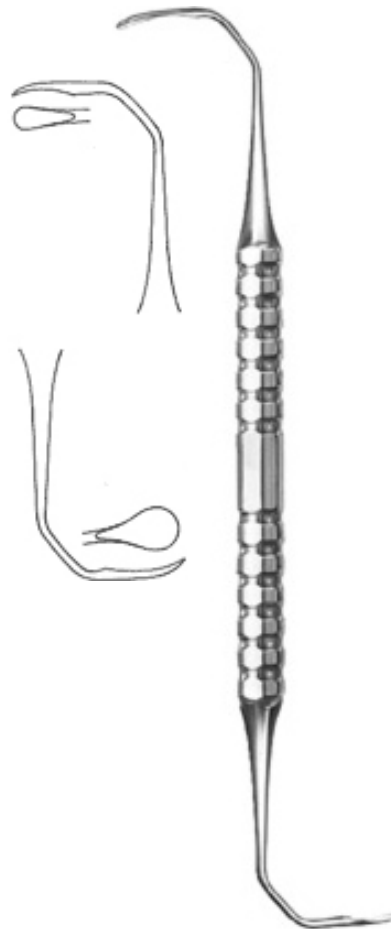

ZI-24-016-04
15cm 6"
Sinus Lift Curette
Fig. 4

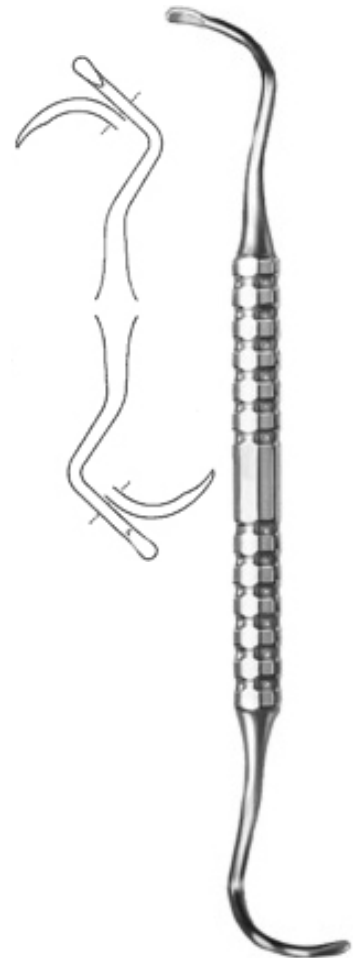

ZI-24-016-05
15cm 6"
Sinus Lift Curette
Fig. 5



ZARYAB
INSTRUMENTS

Products that saves life

Oral Maxillo Facial Surge



ZI-24-050-45
Lindemann
4.5cm 1 3/4"
Burrworking length
10 mm
for vertical cuts
in the buccal
aspect of the mandible



ZI-24-050-65
Lindemann
6.5cm 2 1/2"
Burrworking length
22 mm
for vertical cuts in
the buccal aspect of the
mandible



ZI-24-050-80
Lindemann
8cm 3 1/4"
Burrworking length
35 mm
for vertical cuts in
the buccal aspect of the
mandible



Oral Maxillo Facial Surge



ZI-24-103-01
Adams
Napkin Holder
Napkin Holder
consisting of chain
and two crocodile forceps



ZI-24-111-02
Langenbeck
7cm 2 3/4"
Finger Protector
21 mm Ø

ZI-24-120-10
Mauder
9.5cm 3 3/4"
Mouth Gag
wood



ZI-24-127-02
Pitha
Mouth Gag
28 x 30 mm
with chain silicone





Oral Maxillo Facial Surge



ZI-24-130-50
McKesson
Mouth Gagextra large,
for edentulous plastic coated
metal frame
without chain

ZI-24-130-52
McKesson
Mouth Gaglarge,
for adults plastic
coated metal frame
without chain

ZI-24-130-54
McKesson
Mouth Gagregular,
for adults plastic
coated metal frame
without chain

ZI-24-130-56
McKesson
Mouth Gagsmall,
for children
plastic coated metal frame
without chain

ZI-24-130-58
McKesson
Mouth Gagsmall,
for babies
plastic coated metal frame
without chain



ZI-24-131-50
McKesson
Mouth Gaglarge,
for adults
plastic coated metal frame
with chain

ZI-24-131-52
McKesson
Mouth Gagregular,
for adults
plastic coated metal frame
with chain

ZI-24-131-56
McKesson
Mouth Gagsmall,
for children
plastic coated metal frame
with chain

ZI-24-131-58
McKesson
Mouth Gag
small, for babies
plastic coated metal frame
with chain



ZARYAB
INSTRUMENTS

Products that saves life

Oral Maxillo Facial Surge



ZI-24-140-13
Heister
13cm 5"
Mouth Gag



ZI-24-150-11
Obwe geser
11cm 4 1/4"
Mouth Gag



ZARYAB
INSTRUMENTS

Products that saves life

Oral Maxillo Facial Surge



ZI-24-161-11
Molt
11cm 4 1/4"
Mouth Gag



ZI-24-161-14
Molt
13cm 5"
Mouth Gag



Oral Maxillo Facial Surge

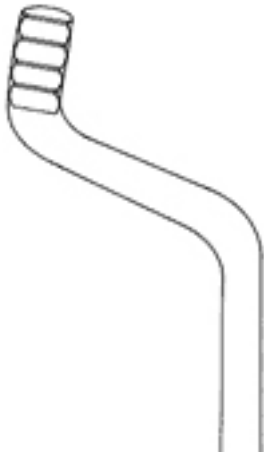

ZI-24-179-16
Roser-König
16cm 6 1/4"
Mouth Gag

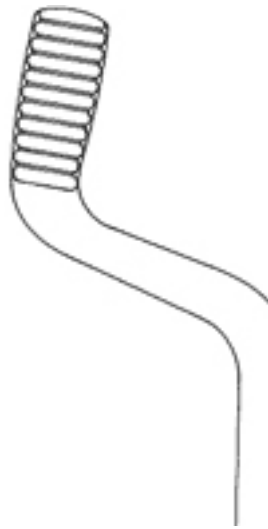

ZI-24-179-20
Roser-König
20cm 8"
Mouth Gag



ZI-24-171-12
Denhart
13cm 5"
Mouth Gag
jaws 16 mm





ZARYAB
I N S T R U M E N T S

Products that saves life

Oral Maxillo Facial Surge



ZI-24-196-00
Kilner-Doughty
Chest Support
Chest Support adjustable height



ZARYAB
I N S T R U M E N T S

Products that saves life

Oral Maxillo Facial Surge



ZI-24-198-00
Kilner-Doughty
Mouth Gag
complete with frame,
3 tongue depressors,
2 tooth plates and 1 palate plate



ZARYAB
I N S T R U M E N T S

Products that saves life

Oral Maxillo Facial Surge



ZI-24-198-01
Kilner-Doughty
13.5cm 5 1/4"
Tongue Depressor
70 x 29 mm
fenestrated blade for
suction Tongue Depressor



ZI-24-198-02
Kilner-Doughty
13.5cm 5 1/4"
Tongue Depressor
80 x 34 mm
fenestrated blade for
suction Tongue Depressor



ZI-248-198-03
Kilner-Doughty
13.5cm 5 1/4"
Tongue Depressor
85 x 38 mm
fenestrated blade for
suction Tongue Depressor



ZARYAB
I N S T R U M E N T S

Products that saves life

Oral Maxillo Facial Surge



ZI-24-198-10
Kilner-Doughty
14.5cm 5 3/4"
Frame for Mouth Gag
Frame for Mouth Gag



ZARYAB
I N S T R U M E N T S

Products that saves life

Oral Maxillo Facial Surge



ZI-24-212-00
Davis-Boyle
Mouth Gag complete,
consisting of frame
and five tongue
depressors no. 1 to 5



ZARYAB
I N S T R U M E N T S

Products that saves life

Oral Maxillo Facial Surge



ZI-24-212-01
Davis-Boyle
13.5cm 5 1/4"
Tongue Depressor
110 x 26 mm
with fixed suction tube
Tongue Depressor



Oral Maxillo Facial Surge

ZI-24-212-02
Davis-Boyle
13.5cm 5 1/4"
Tongue Depressor
95 x 25 mm
with fixed suction tube
Tongue Depressor



ZI-24-212-03
Davis-Boyle
13.5cm 5 1/4"
Tongue Depressor
80 x 24 mm
with fixed suction tube
Tongue Depressor

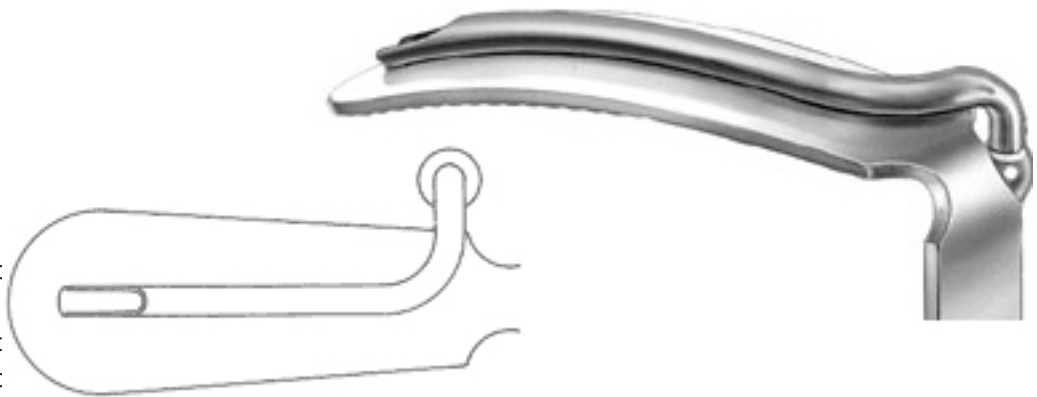

ZI-24-212-04
Davis-Boyle
13.5cm 5 1/4"
Tongue Depressor
65 x 23 mm
with fixed suction tube
Tongue Depressor



ZI-24-212-05
Davis-Boyle
13.5cm 5 1/4"
Tongue Depressor
30 x 20 mm
without suction tube
Tongue Depressor

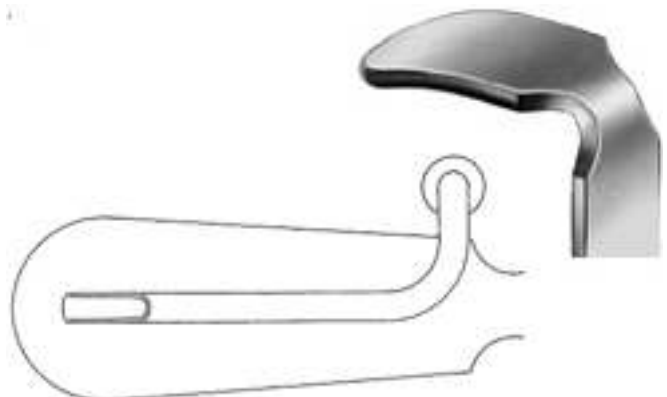



ZARYAB
I N S T R U M E N T S

Products that saves life

Oral Maxillo Facial Surge



ZI-24-212-05
Davis-Boyle
13.5cm 5 1/4"
Tongue Depressor
30 x 20 mm
without suction tube
Tongue Depressor

ZI-24-212-10
Davis-Boyle
14.5cm 5 3/4"
Frame for Mouth Gag
Frame for Mouth Gag





Oral Maxillo Facial Surge

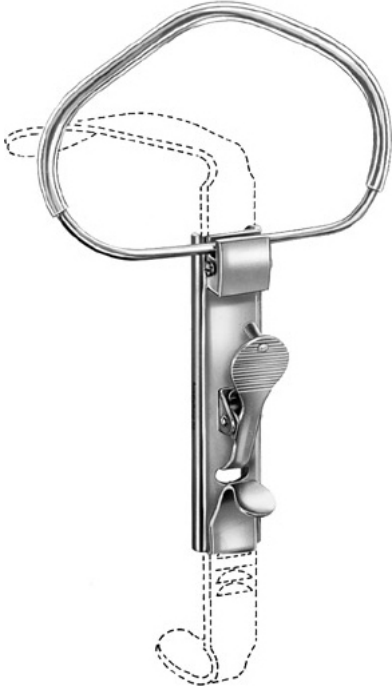

ZI-24-222-00
Mclvor
Mouth Gagcomplete

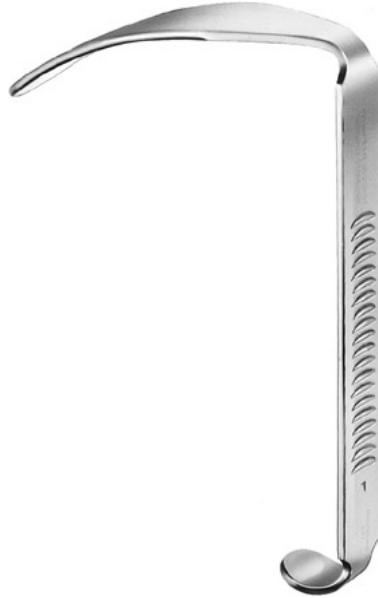

ZI-24-222-01
Mclvor
13.5cm 5 1/4"
Tongue Depressor
100 x 26 mm
Tongue Depressor

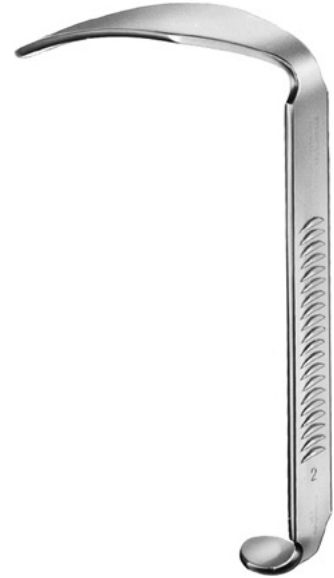

ZI-24-222-02
Mclvor
13.5cm 5 1/4"
Tongue Depressor
85 x 25 mm
Tongue Depressor

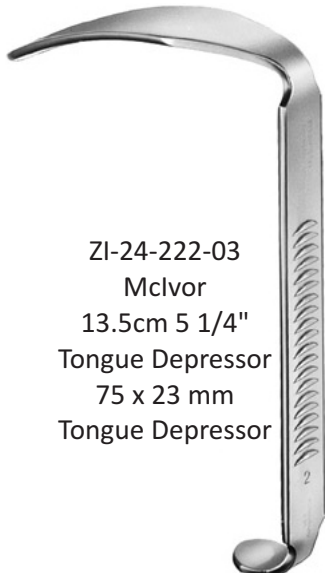

ZI-24-222-03
Mclvor
13.5cm 5 1/4"
Tongue Depressor
75 x 23 mm
Tongue Depressor

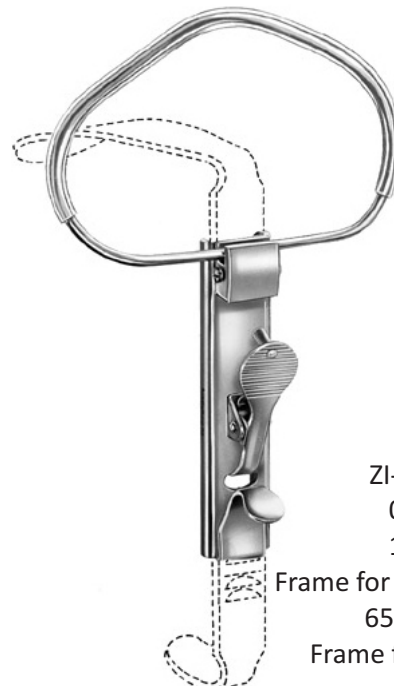

ZI-24-222-1
OMclvor
15cm 6"
Frame for Mouth Gagframe
65 x 100 mm
Frame for Mouth Gag



Oral Maxillo Facial Surge

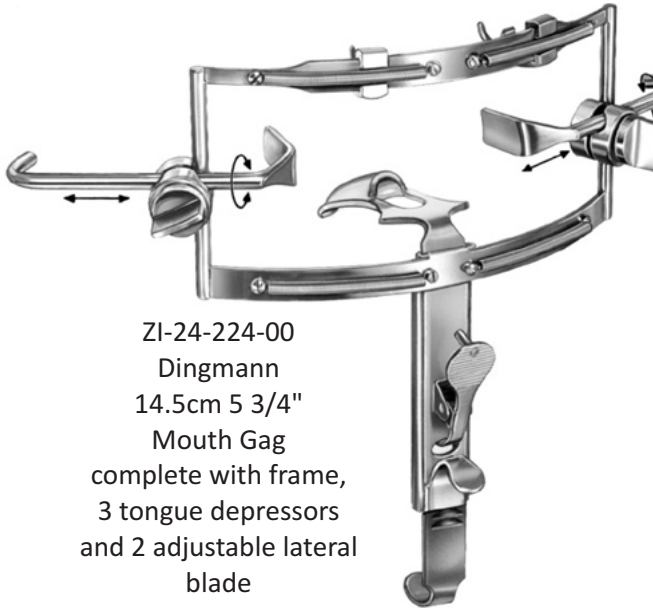

ZI-24-224-00
Dingmann
14.5cm 5 3/4"
Mouth Gag
complete with frame,
3 tongue depressors
and 2 adjustable lateral
blade



ZI-24-224-01
Dingmann
13.5cm 5 1/4"
Tongue Depressor
65 x 25 mm
Tongue Depressor



ZI-24-224-02
Dingmann
13.5cm 5 1/4"
Tongue Depressor
70 x 29 mm
Tongue Depressor



ZI-24-224-03
Dingmann
13.5cm 5 1/4"
Tongue Depressor
80 x 32 mm
Tongue Depressor



ZARYAB
I N S T R U M E N T S

Products that saves life

Oral Maxillo Facial Surge



ZI-24-237-09
Jennings
10.5cm 4"
Mouth Gag

ZI-24-237-11
Jennings
12.5cm 5"
Mouth Gag

ZI-24-237-13
Jennings
14.5cm 5 3/4"
Mouth Gag

ZI-24-237-15
Jennings
16.5cm 6 1/2"
Mouth Gag



Oral Maxillo Facial Surge

ZI-24-240-000
ringer
9.5cm 3 3/4"
Lip and Cheek Retractor
95 mm
for childrenself-retaining



ZI-24-240-01
Oringer
10cm 4 "
Lip and Cheek Retractor
110 mm
self-retaining

ZI-24-240-020
ringer
10.5cm 4"
Lip and Cheek Retractor
115 mm
self-retaining

ZI-24-240-03
Oringer
11cm 4 1/4"
Lip and Cheek Retractor
120 mm
self-retaining

ZI-24-240-13
Oringer
Lip and Cheek Retractor
set with no. 1-3
self-retaining

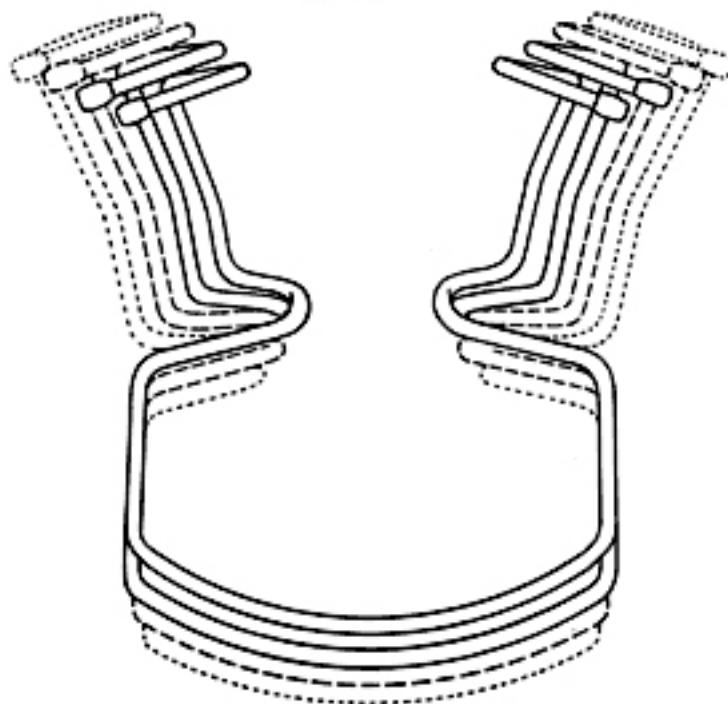



Oral Maxillo Facial Surge



ZI-24-243-11
Martin-Simplex
10.5cm 4"
Cheek Retractor



ZI-24-246-14
14cm 5 1/2"
Vestibulum Retractor
Vestibulum Retractor



ZI-24-249-14
Sternberg
14cm 5 1/2"
Lip and Cheek
Retractor
26 / 37 mm



ZI-24-251-12
Obwegeser
12cm 4 3/4"
Cheek Retractor



ZI-24-261-13
Bishop
13.5cm 5 1/4"
Lip and Cheek Retractor



ZARYAB
INSTRUMENTS

Products that saves life

Oral Maxillo Facial Surge



ZI-24-263-15
Cawood-Minnesota
15cm 6"
Cheek Retractor
20 mm



ZI-24-265-00
14.5cm 5 3/4"
Cheek Retractor
fenestrated





ZARYAB
I N S T R U M E N T S

Products that saves life

Oral Maxillo Facial Surge



ZI-24-271-15
Hartmann
15cm 6"
Tongue Depress or blade
72 x 23 mm

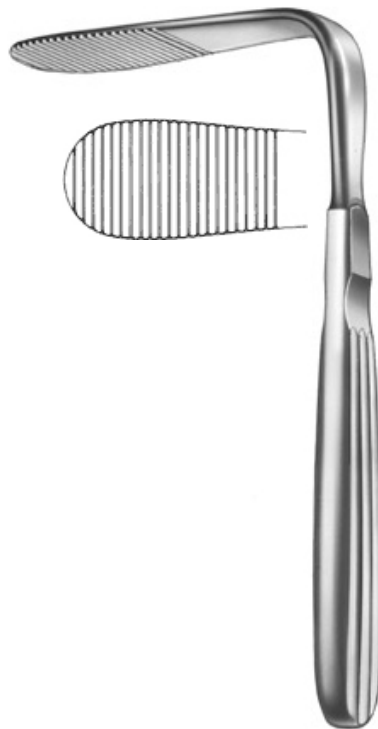

ZI-24-277-14
Tobold
15cm 6"
Tongue Depress or blade
88 x 25 mm

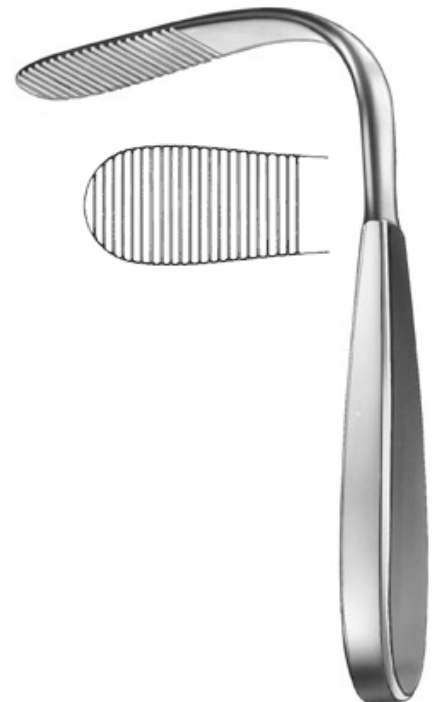

ZI-24-281-14
Tobold
14.5cm 5 3/4"
Tongue Depress or blade
85 x 24 mm



ZARYAB
I N S T R U M E N T S

Products that saves life

Oral Maxillo Facial Surge

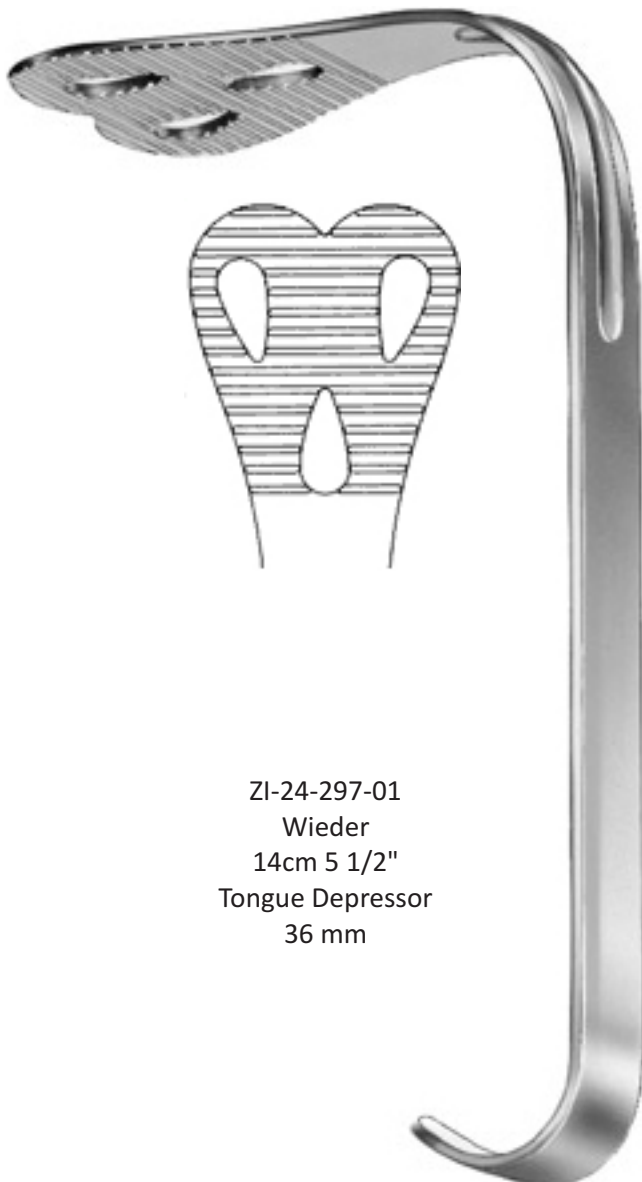

ZI-24-297-01
Wieder
14cm 5 1/2"
Tongue Depressor
36 mm

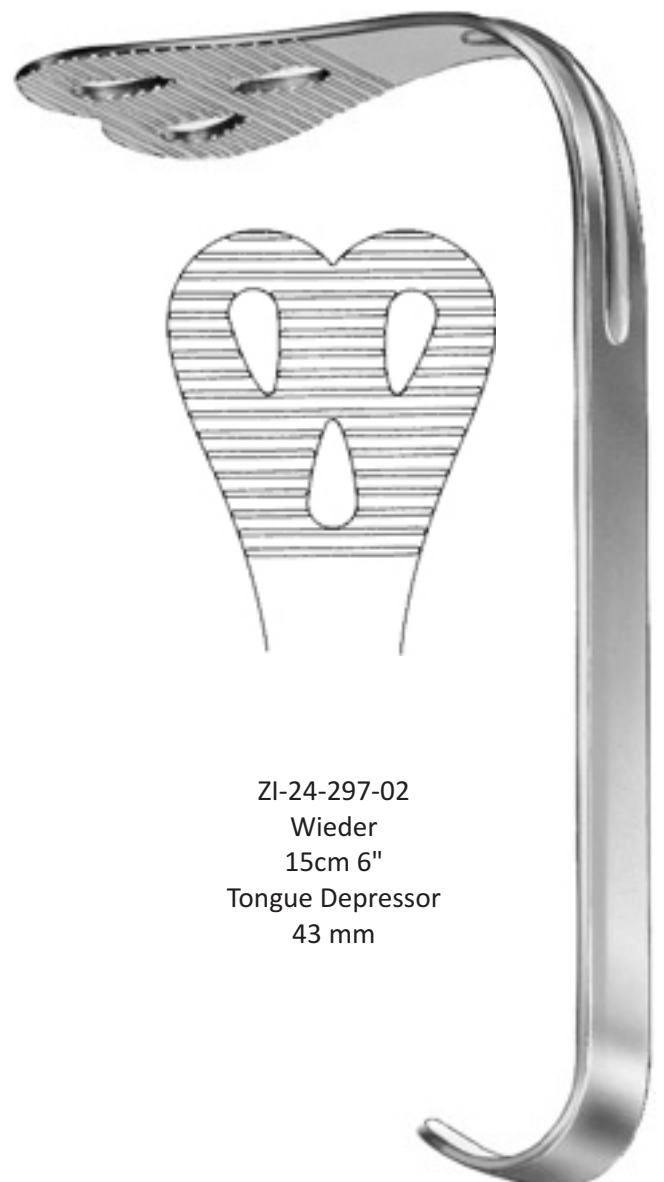

ZI-24-297-02
Wieder
15cm 6"
Tongue Depressor
43 mm



ZARYAB
INSTRUMENTS

Products that saves life

Oral Maxillo Facial Surge



ZI-24-350-16
16cm 6 1/4"
Tongue Spatula
package of 100
pieces wood



ZI-24-352-15
15cm 6"
Tongue Spatula
package of 100
pieces plastic



ZARYAB
I N S T R U M E N T S

Products that saves life

Oral Maxillo Facial Surge



ZI-24-363-18
Martin
18.5cm 7 1/4"
Tongue Spatula
nylon

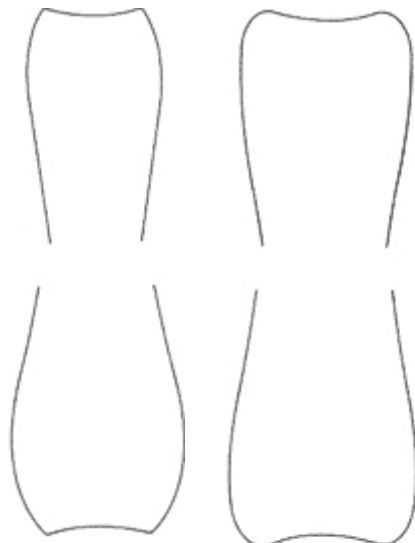

ZI-24-375-13
Doyen
13.5cm 5 1/4"
Tongue Spatula

ZI-24-375-16
Doyen
16cm 6 1/4"
Tongue Spatula



ZI-24-385-19
Brünings
19cm 7 1/2"
Tongue Spatula



Oral Maxillo Facial Surge



ZI-24-452-17
Collin
17cm 6 3/4"
Tongue Holding Forceps
jaw 24 x 27 mm

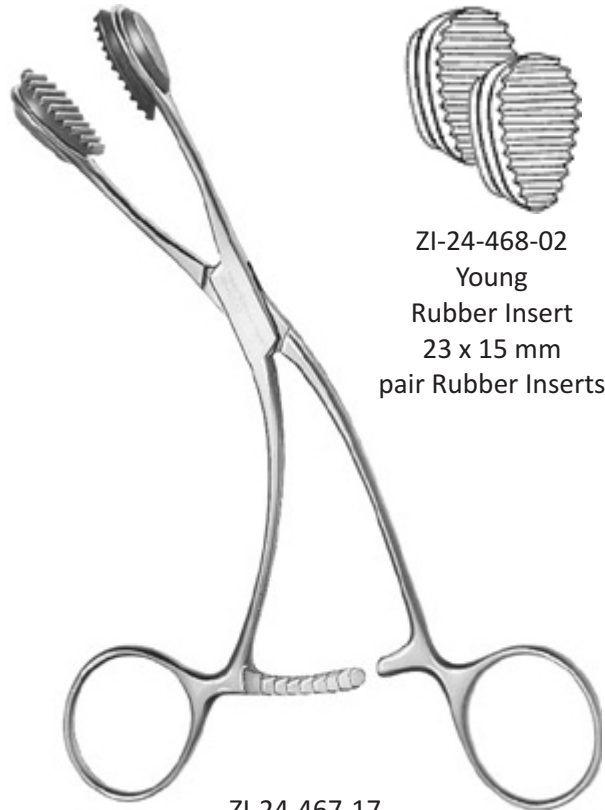

ZI-24-467-17
Young
15cm 6"
Tongue Holding Forceps

ZI-24-468-02
Young
Rubber Insert
23 x 15 mm
pair Rubber Inserts



Oral Maxillo Facial Surge



ZI-24-501-24
22cm 8 3/4" Extra Oral Retractor
9,5 mm / 16 mm
concave blade, fully bent tip

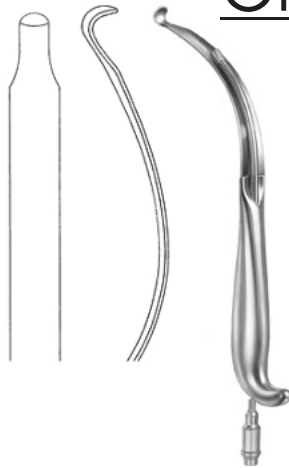

ZI-24-503-27
25.5cm 10" Extra Oral Retractor
9,5 mm / 16 mm concave blade,
fully bent tip with fiber optic light carrier



ZI-24-505-24
23cm 9"
Intra Oral Retractor
25,5 mm
for LeFort osteotomies



ZI-24-507-27
27cm 10 3/4"
Intra Oral Retractor 25,5 mm
for LeFort osteotomies
with fiber optic light carrier

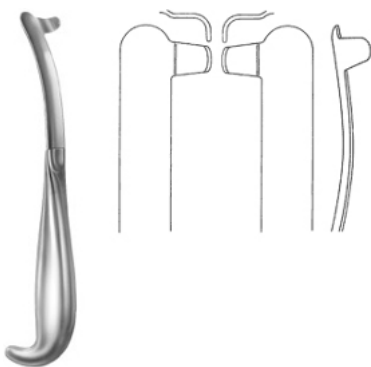

ZI-24-509-21
21cm 8 1/4" Intra Oral Retractor
26,5 / 16 mm right



ZI-24-511-21
21cm 8 1/4" Intra Oral Retractor
26,5 / 16 mm left

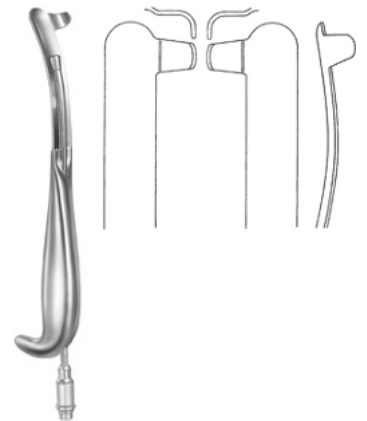

ZI-24-513-24
24.5cm 9 3/4" Intra Oral Retractor
26,5 / 16 mm right with
fiber optic light carrier

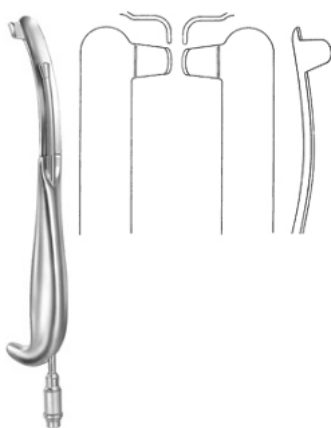

ZI-24-515-24
24.5cm 9 3/4" Intra Oral Retractor
26,5 / 16 mm left with
fiber optic light carrier

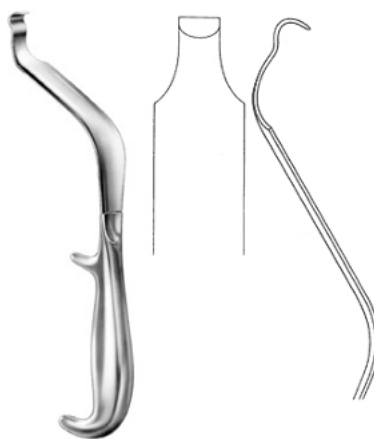

ZI-24-517-25
25cm 9 3/4" Intra Oral Retractor
12,5 / 27 mm L&M,
for vertical osteotomy

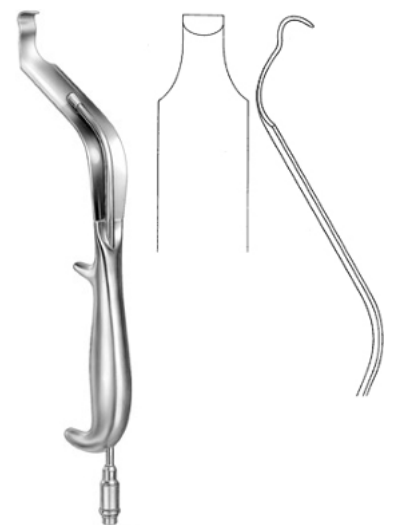

ZI-24-519-28
28cm 11" Intra Oral Retractor
12,5 / 27 mm L&M, for vertical osteoto
my with fiber optic light carrier



Oral Maxillo Facial Surge

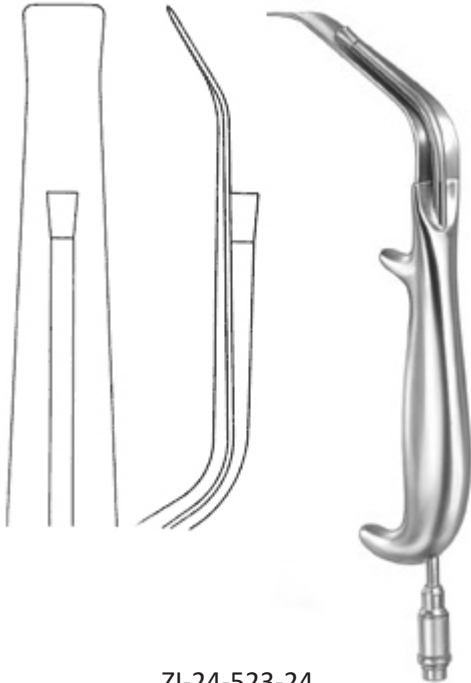

ZI-24-523-24
Shea
22cm 8 3/4"
Multi purpose
Retractor 14,5 mm
with fiber optic light carrier
Multi Purpose Retractor



ZI-24-603-400
bwegeser
21.5cm 8 1/2"
Soft Tissue Retractor
blade 43 x 11 mm

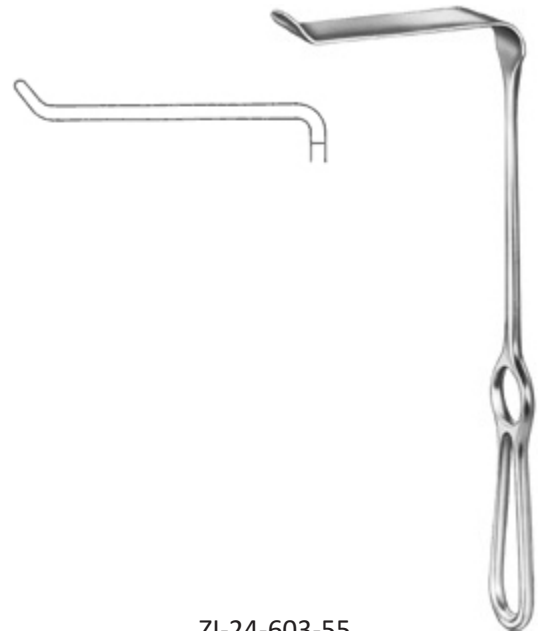

ZI-24-603-55
Obwegeser
21.5cm 8 1/2"
Soft Tissue Retractor
blade 57 x 11 mm

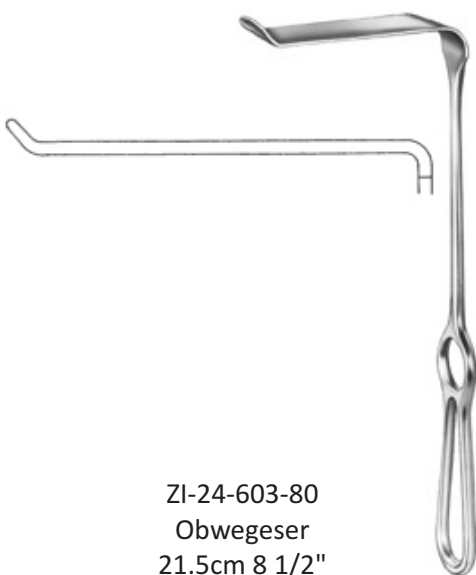

ZI-24-603-80
Obwegeser
21.5cm 8 1/2"
Soft Tissue Retractor
blade 83 x 16 mm

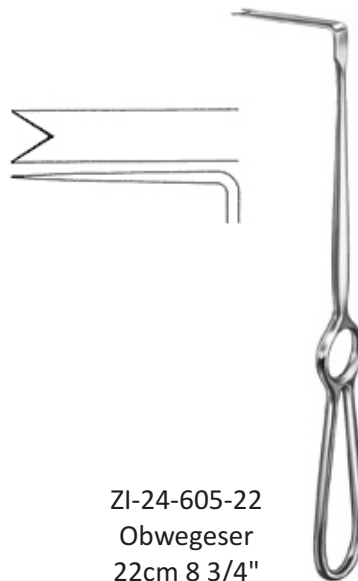

ZI-24-605-22
Obwegeser
22cm 8 3/4"
Nasal Spine Retractor
blade 45 x 10 mm
Nasal Spine Retractor

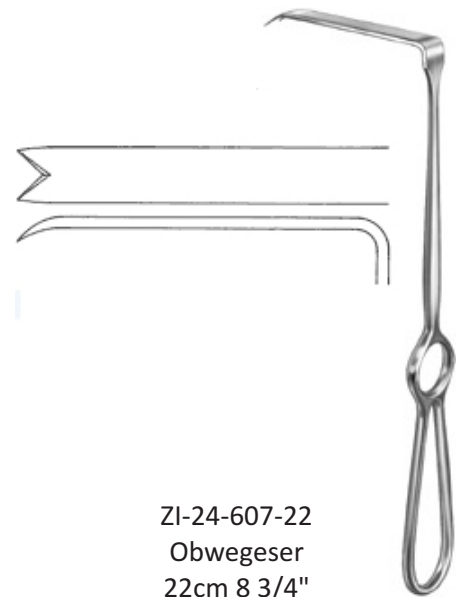

ZI-24-607-22
Obwegeser
22cm 8 3/4"
Ramus Retractor
blade 72 x 10 mm



ZARYAB
I N S T R U M E N T S

Products that saves life

Oral Maxillo Facial Surge



ZI-24-611-16
Obwegeser
16.5cm 6 1/2"
Chin Retractor



ZI-24-613-08
Obwegeser
17cm 6 3/4"
Channel Retractor
8 mm

ZI-24-613-10
Obwegeser
17cm 6 3/4"
Channel Retractor
10 mm



ZARYAB
I N S T R U M E N T S

Products that saves life

Oral Maxillo Facial Surge

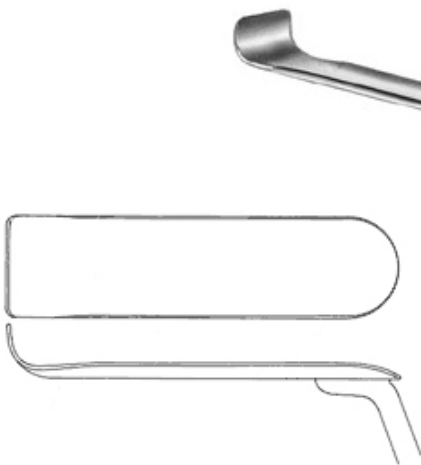

ZI-24-614-10
Schuchardt
15cm 6 "
Progeny Retractor

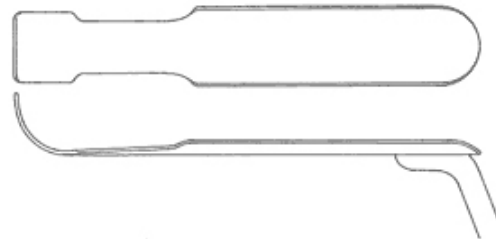

ZI-24-614-20
Metz
15cm 6 "
Progeny Retractor





ZARYAB
I N S T R U M E N T S

Products that saves life

Oral Maxillo Facial Surge



ZI-24-616-01
18.5cm 7 1/4"
Retractor 14 x 7 mm



ZI-24-616-02
Koberg, mod.
18.5cm 7 1/4"
Retractor 20 x 7 mm



ZARYAB
I N S T R U M E N T S

Products that saves life

Oral Maxillo Facial Surge



ZI-24-618-01
18cm 7"
Periosteal Elevator
3 x 18 mm

ZI-24-618-02
18cm 7"
Periosteal Elevator
3,5 x 23 mm



ZARYAB
INSTRUMENTS

Products that saves life

Oral Maxillo Facial Surge

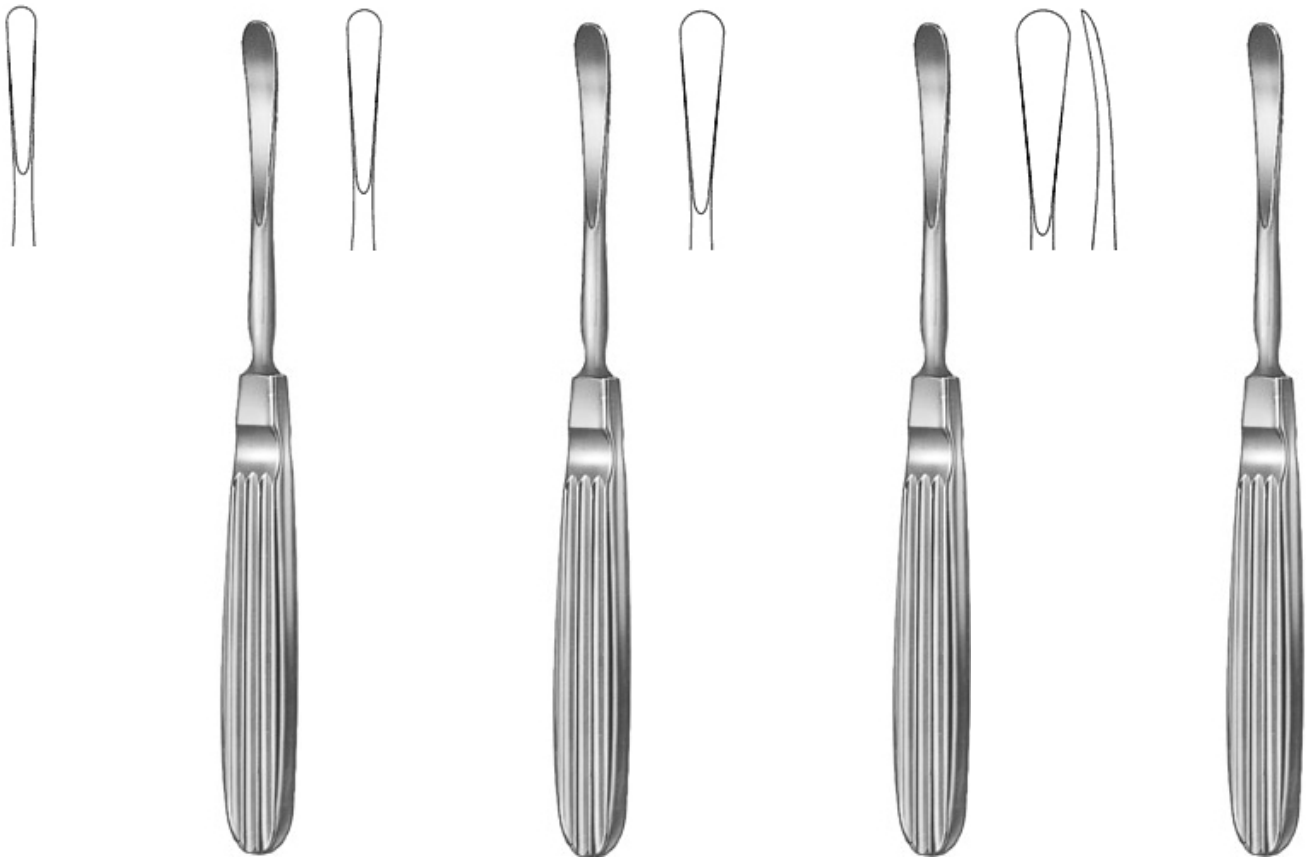

ZI-24-630-06
Obwegeser
17.5cm 7"
Periosteal Elevator
6 mm

ZI-24-630-07
Obwegeser
17.5cm 7"
Periosteal Elevator
7 mm

ZI-24-630-09
Obwegeser
17.5cm 7"
Periosteal Elevator
9 mm

ZI-24-630-11
Obwegeser
17.5cm 7"
Periosteal Elevator
11 mm



ZARYAB
INSTRUMENTS

Products that saves life

Oral Maxillo Facial Surge



ZI-24-631-05
Obwegeser
20.5cm 8"
Periosteal Elevator
5 mm

ZI-24-631-07
Obwegeser
20.5cm 8"
Periosteal Elevator
7 mm

ZI-24-631-09
Obwegeser
20.5cm 8"
Periosteal Elevator
9 mm



ZARYAB
I N S T R U M E N T S

Products that saves life

Oral Maxillo Facial Surge

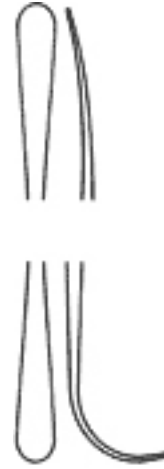

ZI-24-632-01
Obwegeser
17.5cm 7"
Periosteal Elevator

ZI-24-632-02
Obwegeser
17.5cm 7"
Periosteal Elevator

ZI-24-640-21
Obwegeser
20.5cm 8"
Elevator

ZI-24-642-21
Obwegeser
20.5cm 8"
Elevator



ZARYAB
I N S T R U M E N T S

Products that saves life

Oral Maxillo Facial Surge



ZI-24-682-01
Schuchardt
Lattice Splint package with
10 pieces



ZI-24-682-02
Schuchardt
Lattice Splint package with
10 pieces

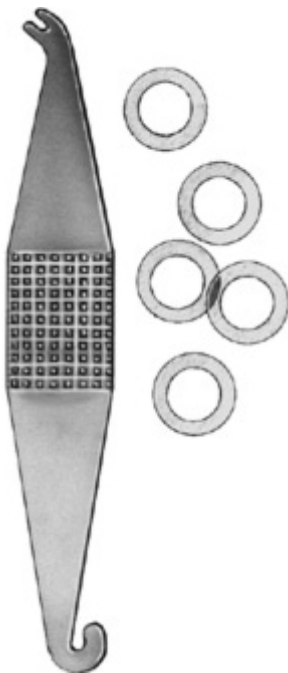

ZI-24-682-04
Rubber Band package with
300 rings 4 mm Ø
Rubber Bands

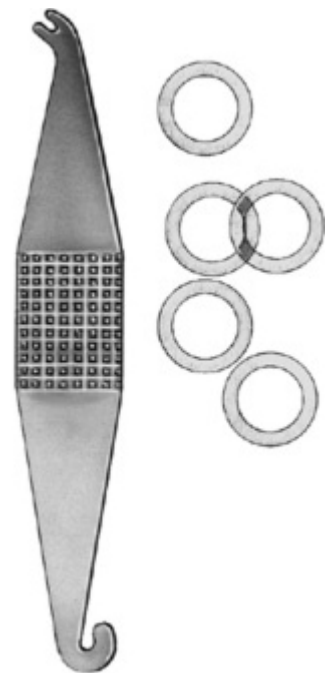

ZI-24-682-06
Rubber Band package with
300 rings 6 mm Ø
Rubber Bands



ZARYAB
INSTRUMENTS

Products that saves life

Oral Maxillo Facial Surge



ZI-24-683-13
Dautrey
13cm 5"
Lattice Splint



ZI-24-685-00
17cm 6 3/4"
Wire Pusher



ZI-24-688-00
Rowe
15cm 6"
Wire Pusher

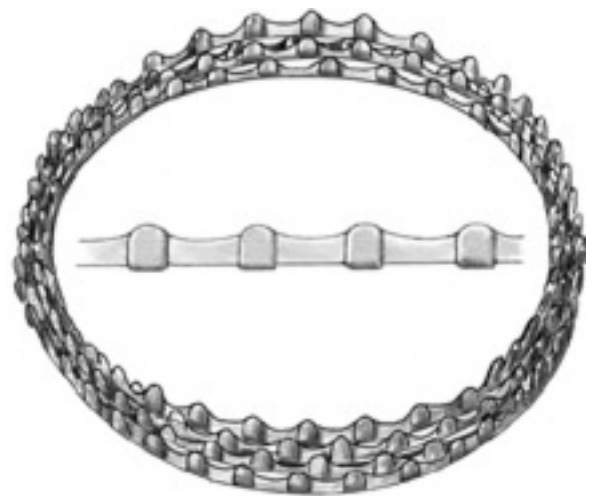

ZI-24-690-00
Erich
Arch Bar



Oral Maxillo Facial Surge

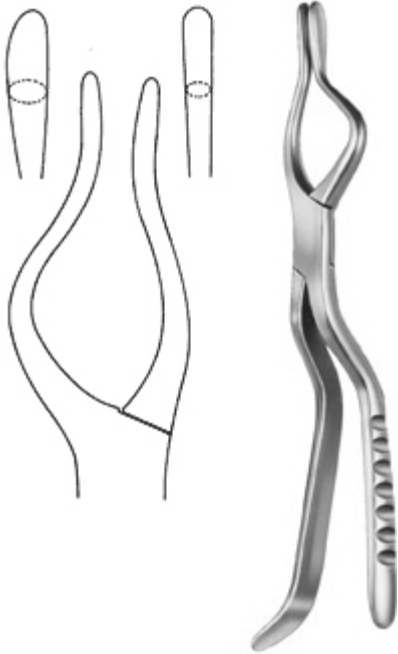

ZI-24-700-01
Rowe
22.5cm 9"
Disimpaction Forceps
left L

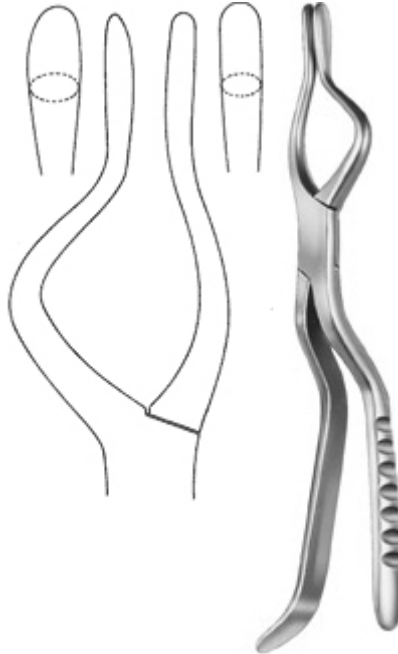

ZI-24-700-02
Rowe
23.5cm 9 1/4"
Disimpaction Forceps
left L

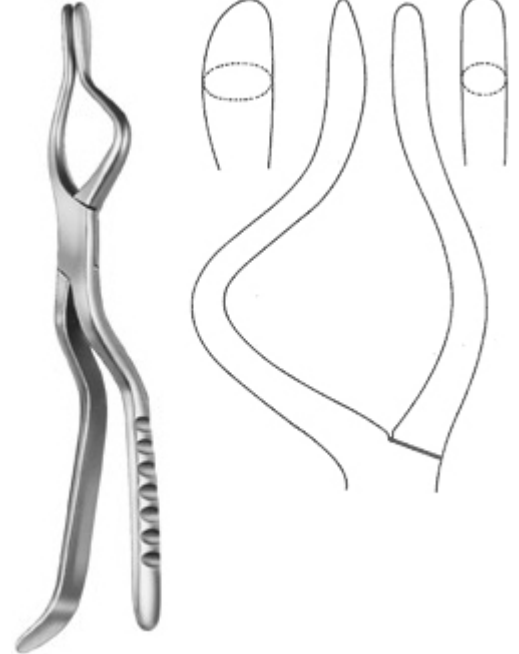

ZI-24-700-03
Rowe
24cm 9 1/2"
Disimpaction Forceps
left L

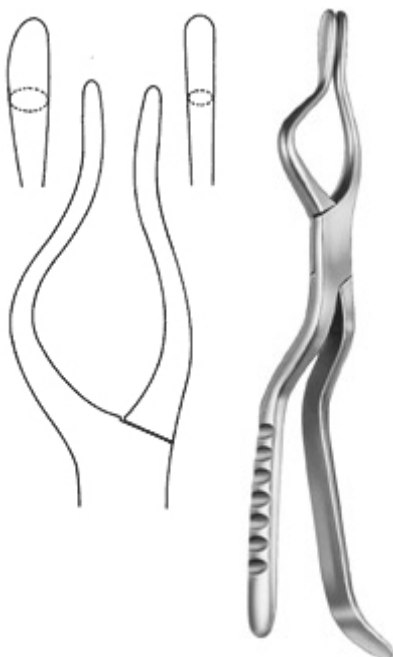

ZI-24-701-01
Rowe
22.5cm 9"
Disimpaction Forceps
right R

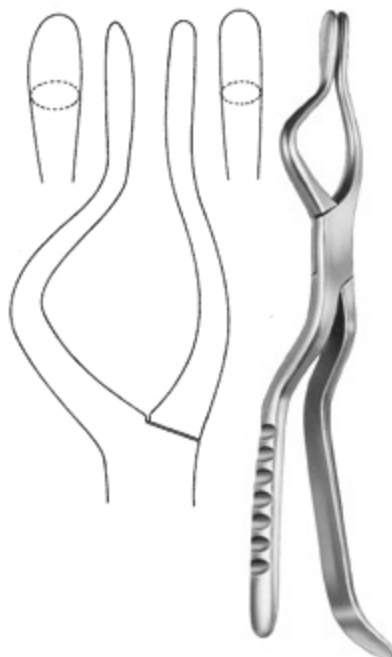

ZI-24-701-02
Rowe
23.5cm 9 1/4"
Disimpaction Forceps
right R

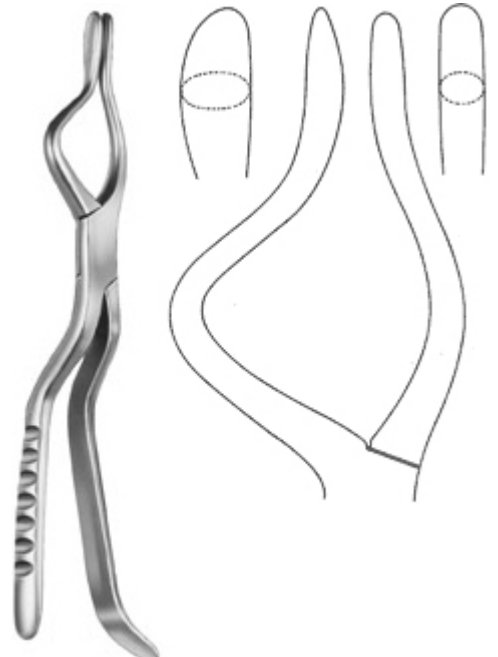

ZI-24-701-03
Rowe
24cm 9 1/2"
Disimpaction Forceps
right R



ZARYAB
INSTRUMENTS

Products that saves life

Oral Maxillo Facial Surge



ZI-24-711-21
Gillies
20cm 8"
Zygoma Elevator



ZI-24-713-21
Dingmann
21cm 8 1/4"
Zygoma Elevator
tip 5,0 mm Ø



ZI-24-715-19
Dingmann-Wilk
20cm 8"
Retractor
ZI-38-718-01
Jeter-Van Sickels
18cm 7"
Bone Holding Forceps
light pattern
for sagittal split procedure



ZARYAB
I N S T R U M E N T S

Products that saves life

Oral Maxillo Facial Surge



ZI-24-718-02
Jeter-Van Sickels
18cm 7"
Bone Holding Forceps
heavy pattern
for sagittal split procedure



ZARYAB
I N S T R U M E N T S

Products that saves life

Oral Maxillo Facial Surge



ZI-24-719-01

Keen

17.5cm 6 3/4"

Bone Holding Forceps
left

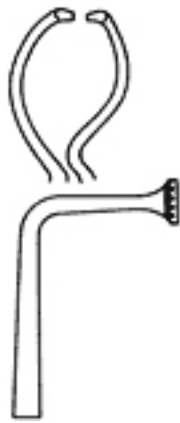

ZI-24-719-02

Keen

17.5cm 6 3/4"

Bone Holding Forceps
right





ZARYAB
I N S T R U M E N T S

Products that saves life

Oral Maxillo Facial Surge



ZI-24-720-01
Steinhäuser
13cm 5"
Bone Holding Forceps



ZI-24-720-02
Steinhäuser
13cm 5"
Bone Holding Forceps
bent downwards



ZARYAB
INSTRUMENTS

Products that saves life

Oral Maxillo Facial Surge



ZI-24-722-25
Wolford
25cm 10"
Bone Holding Forceps



ZI-24-723-16
Salyer
16cm 6 1/2"
Bone Holding Forceps



ZI-24-775-00
Sakamoto
14cm 5 1/2"
Measuring Forceps
Measuring Forceps



ZARYAB
I N S T R U M E N T S

Products that saves life

Oral Maxillo Facial Surge

ZI-24-777-01
Arnhem
22cm 8 3/4"
LeFort I Retractor
right LeFort I Retractor

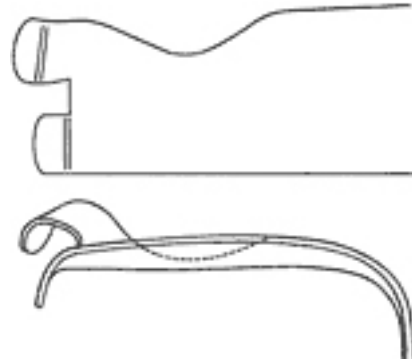

ZI-24-777-02
Arnhem
22cm 8 3/4"
LeFort I Retractor
left LeFort I Retractor

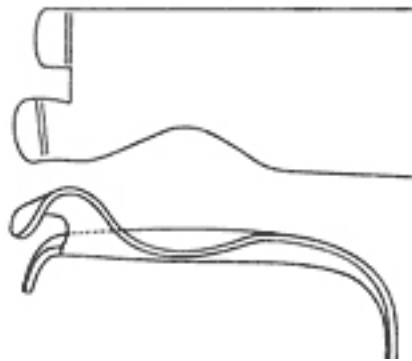

ZI-24-779-01
Arnhem
22cm 8 3/4"
Sinus Lift Retractor right
Sinus Lift Retractor

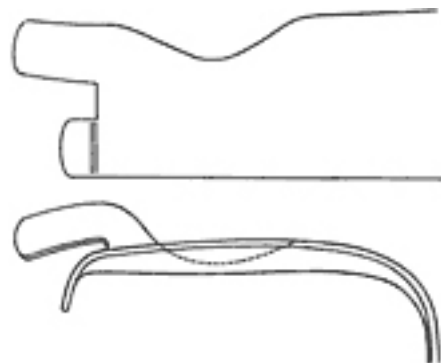

ZI-24-779-02
Arnhem
22cm 8 3/4"
Sinus Lift Retractor left

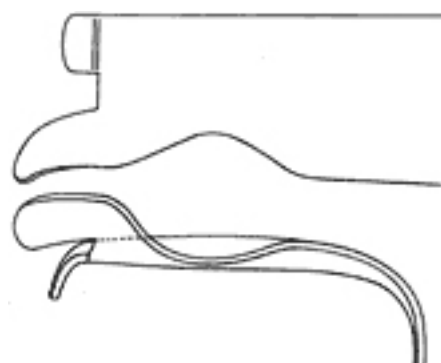



ZARYAB
INSTRUMENTS

Products that saves life

Oral Maxillo Facial Surge



ZI-24-780-00
Bauer
20.5cm 8"
Osteotome
6 mm



ZI-24-780-01
Bauer
20.5cm 8"
Osteotome
8 mm



ZI-24-781-00
Bauer
20.5cm 8"
Osteotome
6 mm



ZI-24-781-01
Bauer
20.5cm 8"
Osteotome
8 mm



ZARYAB
I N S T R U M E N T S

Products that saves life

Oral Maxillo Facial Surge



ZI-24-783-01
Epker-Bauer
17.5cm 7"
Osteotome
8 mm



Oral Maxillo Facial Surge



ZI-24-786-04
Dautrey-Munro
16cm 6 1/4"
Osteotome 4 mm



ZI-24-786-06
Dautrey-Munro
16cm 6 1/4"
Osteotome 6 mm



ZI-24-786-08
Dautrey-Munro
16cm 6 1/4"
Osteotome 8 mm



ZI-24-786-10
Dautrey-Munro
16cm 6 1/4"
Osteotome 10 mm



ZI-24-786-12
Dautrey-Munro
16cm 6 1/4"
Osteotome 12 mm



ZI-24-786-14
Dautrey-Munro
16cm 6 1/4"
Osteotome 14 mm

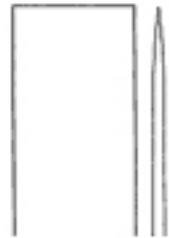

ZI-24-786-16
Dautrey-Munro
16cm 6 1/4"
Osteotome 16 mm



Oral Maxillo Facial Surge



ZI-24-790-04
Dunn-Dautrey
16.5cm 6 ½"
Osteotome
4 mm



ZI-24-790-06
Dunn-Dautrey
16.5cm 6 ½"
Osteotome
6 mm



ZI-24-790-08
Dunn-Dautrey
16.5cm 6 ½"
Osteotome
8 mm

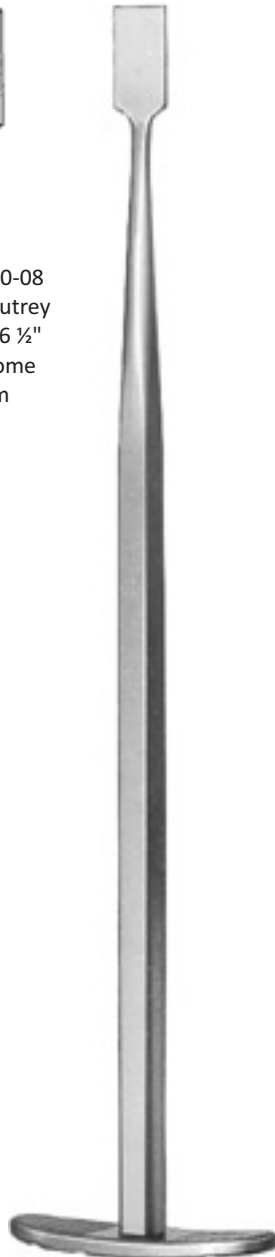

ZI-24-791-01
Dunn-Dautrey
17cm 6 ¾"
Osteotome
6 mm



ZI-24-791-03
Dunn-Dautrey
17cm 6 ¾"
Osteotome
6 mm





Oral Maxillo Facial Surge



ZI-24-796-04
Epker
18cm 7"
Osteotome
4 x 1,2 mm



ZI-24-796-06
Epker
18cm 7"
Osteotome
6 x 1,2 mm



ZI-24-796-08
Epker
18cm 7"
Osteotome
8 x 1,2 mm



ZI-24-797-04
Epker
18cm 7"
Osteotome
4 x 1,2 mm



ZI-24-797-06
Epker
18cm 7"
Osteotome
6 x 1,2 mm





ZARYAB
I N S T R U M E N T S

Products that saves life

Oral Maxillo Facial Surge



ZI-24-799-06
Epker
18cm 7"
Osteotome
6 x 1,2 mm



ZI-24-799-08
Epker
18cm 7"
Osteotome
8 x 1,2 mm





ZARYAB
I N S T R U M E N T S

Products that saves life

Oral Maxillo Facial Surge

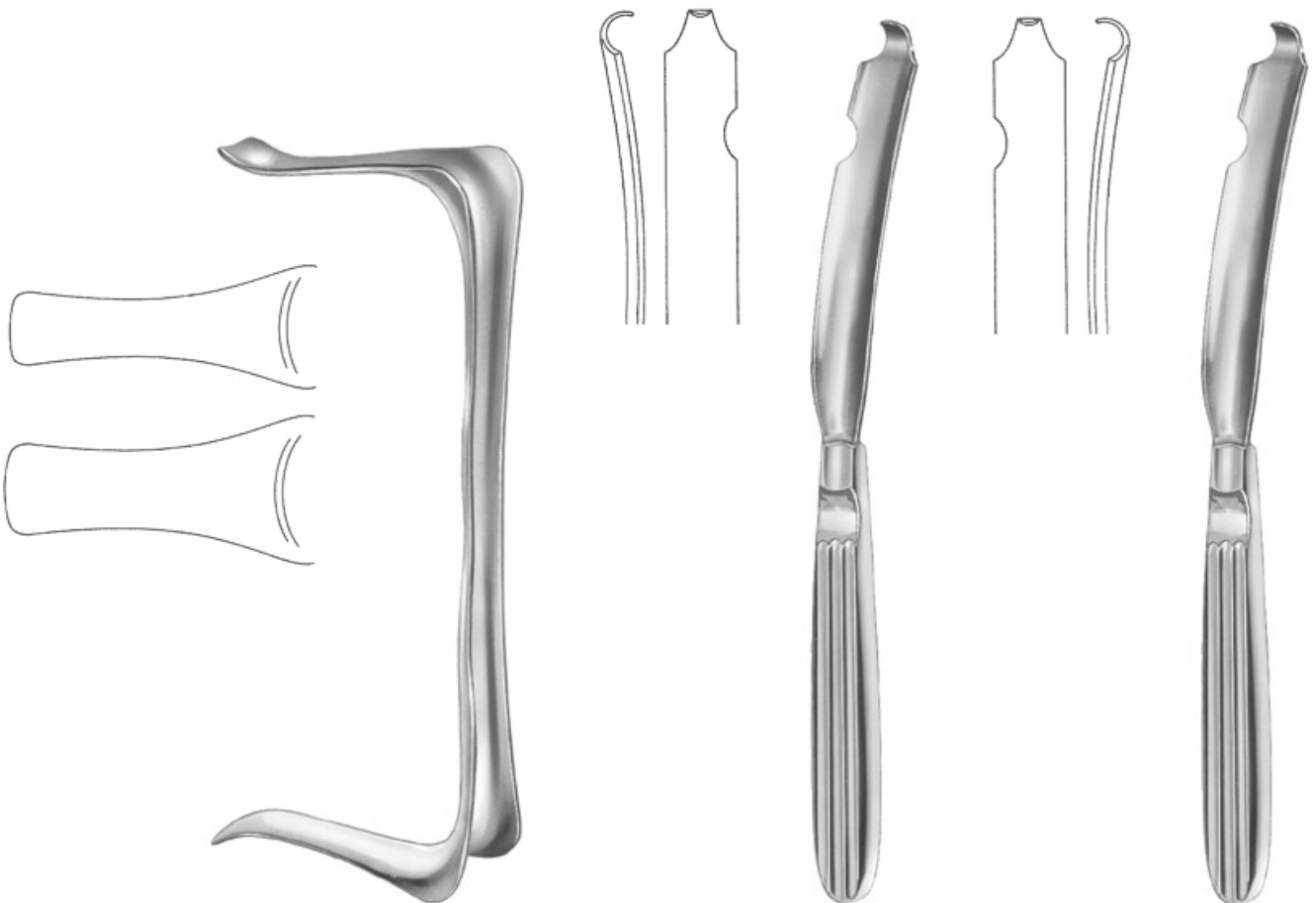

ZI-24-829-00
Hargis
16cm 6 1/4"
Lip and Cheek Retractor

ZI-24-831-01
Hargis
19.5cm 7 3/4"
Ramus Retractor right

ZI-24-831-02
Hargis
19.5cm 7 3/4"
Ramus Retractor left



ZARYAB
INSTRUMENTS

Products that saves life

Oral Maxillo Facial Surge



ZI-24-833-18
Hargis
18cm 7"
Mandibular Body Retractor

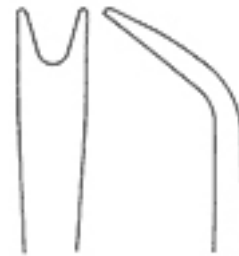

ZI-24-835-19
Hargis
19cm 7 1/2"
Anterior Border Stripper



ZARYAB
INSTRUMENTS

Products that saves life

Oral Maxillo Facial Surge

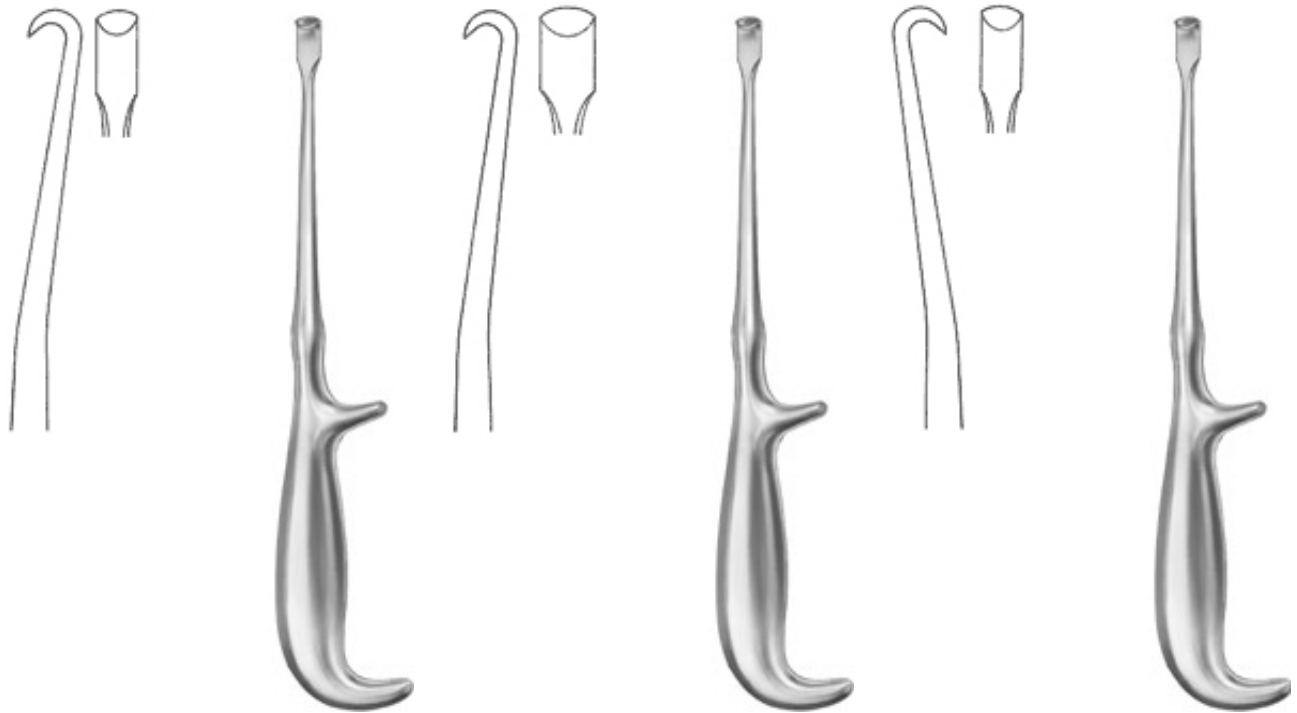

ZI-24-837-01
Hargis
23cm 9"
Periosteal Elevator
6,5 mm right

ZI-24-837-02
Hargis
23cm 9"
Periosteal Elevator
9 mm right

ZI-24-837-03
Hargis
23cm 9"
Periosteal Elevator
6,5 mm left



ZARYAB
I N S T R U M E N T S

Products that saves life

Oral Maxillo Facial Surge



ZI-24-837-04
Hargis
23cm 9"
Periosteal Elevator
9 mm left



ZI-24-839-18
Hargis
18.5cm 7 1/4"
Periform Rim Retractor



ZARYAB
I N S T R U M E N T S

Products that saves life

Oral Maxillo Facial Surge



ZI-24-841-22
Hargis
22cm 8 3/4"
Pterygoid Osteotome

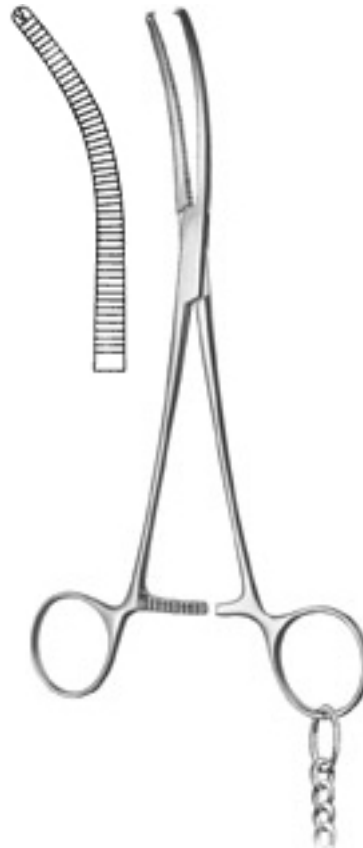

ZI-24-843-19
Hargis
19cm 7 1/2"
Bone Holding Forceps
1:2 teeth with chain



ZI-24-843-99
Hargis
Retractor Chain
for ref. ZI-38-843-19
Retractor Chain, only



ZARYAB
I N S T R U M E N T S

Products that saves life

Oral Maxillo Facial Surge

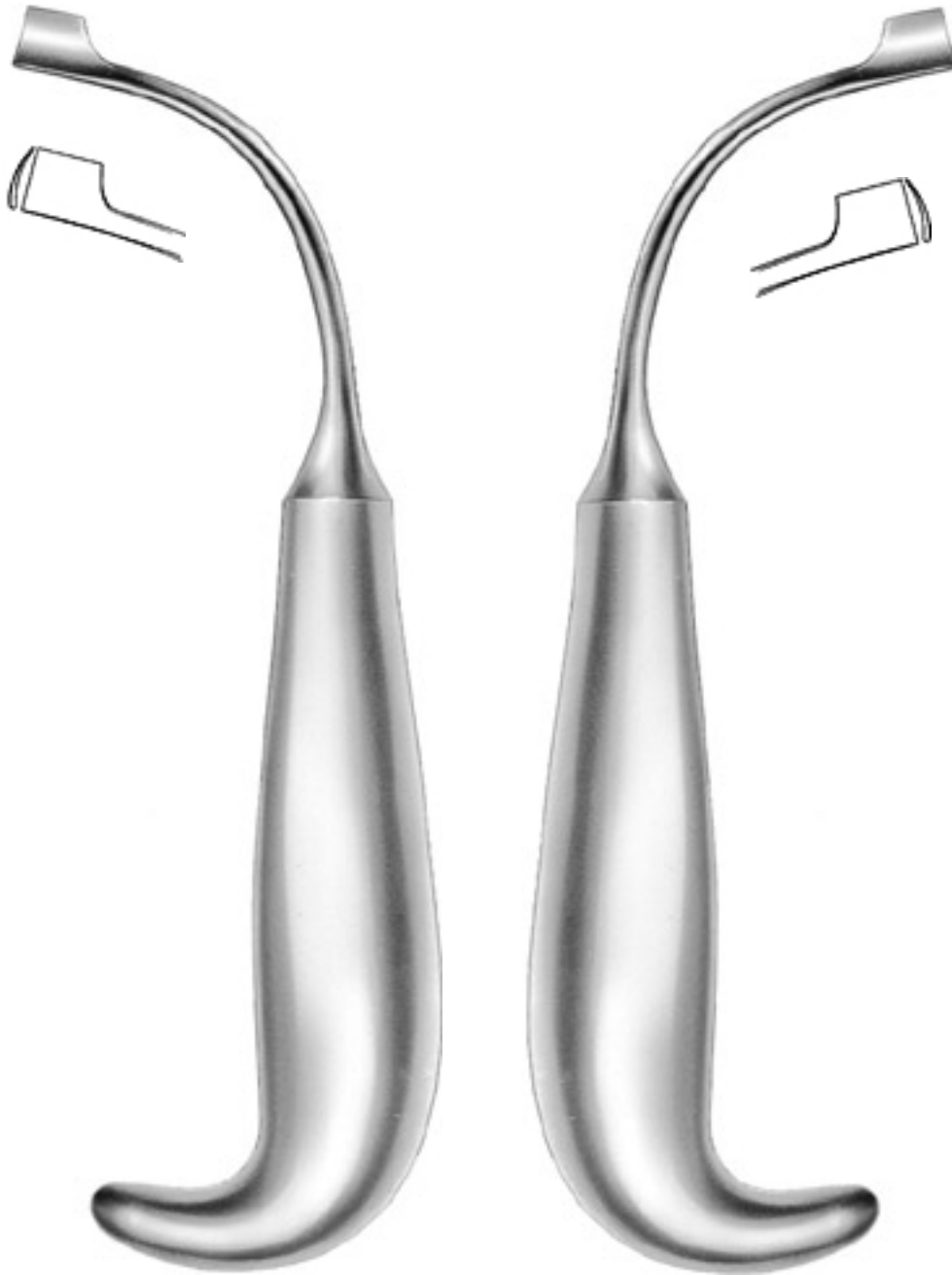

ZI-24-845-01
Smith
18.5cm 7 1/4"
Sagittal Split Separator
9 mm right

ZI-24-845-02
Smith
18.5cm 7 1/4"
Sagittal Split Separator
9 mm left



ZI-24-846-20
Smith
23.5cm 9 1/4"
Ramus Separator



ZARYAB
INSTRUMENTS

Products that saves life

Oral Maxillo Facial Surge

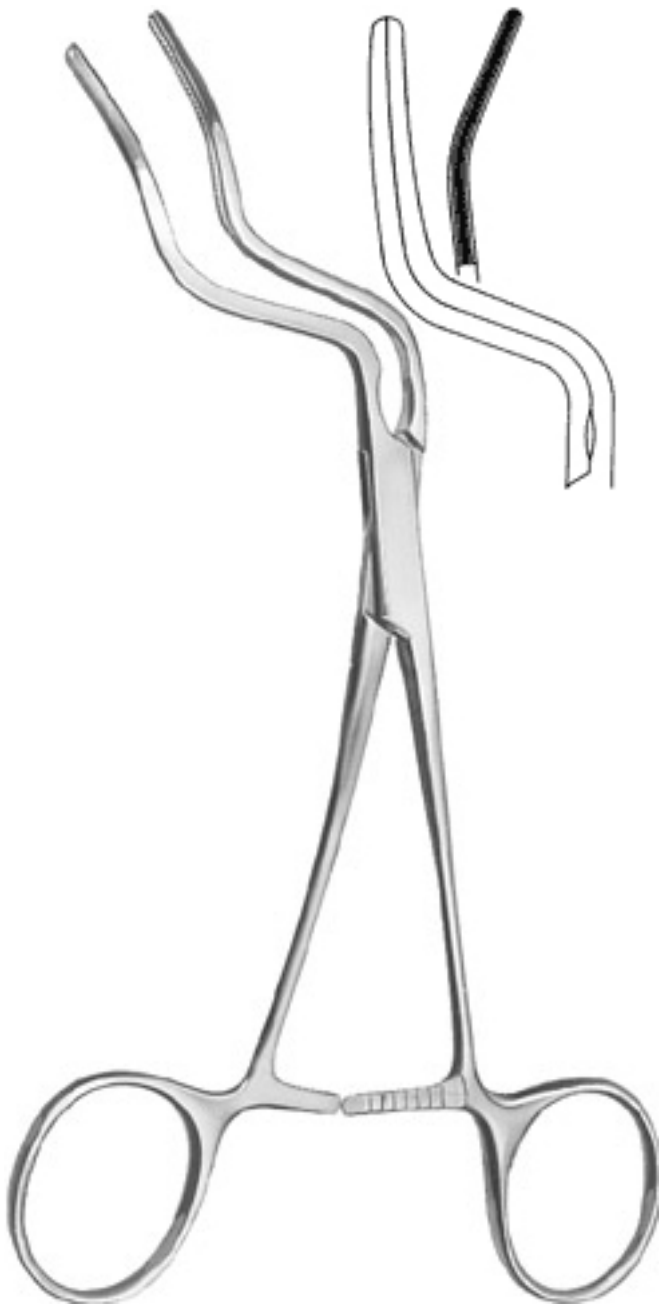

ZI-24-850-01
Terry
17cm 6 3/4"
Mylohyoid Muscle Clamp left

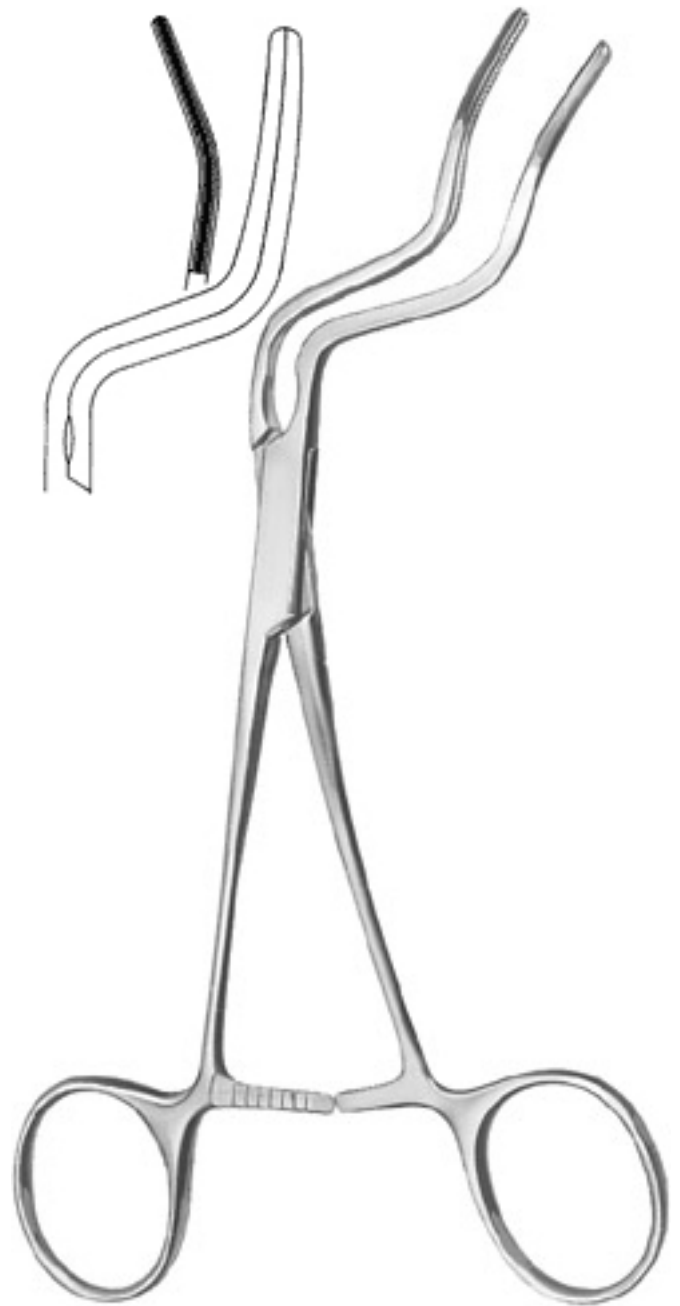

ZI-24-850-02
Terry
17cm 6 3/4"
Mylohyoid Muscle Clamp right



ZARYAB
I N S T R U M E N T S

Products that saves life

Oral Maxillo Facial Surge



ZI-24-851-16
Terry
16.5cm 6 1/2"
Mandibular Retractor

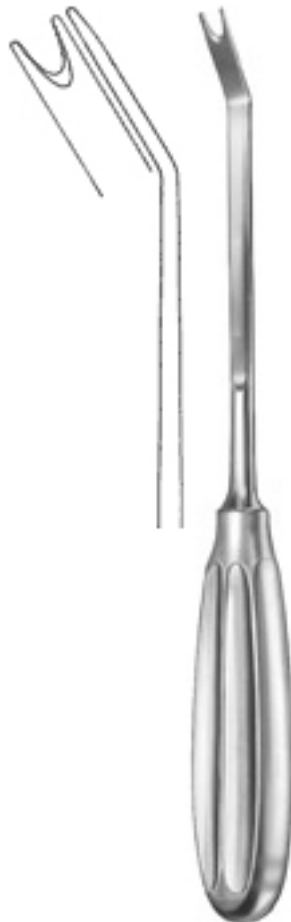

ZI-24-853-24
Terry
24cm 9 1/2"
Ramus Pusher



ZI-24-855-17
Terry
17cm 6 3/4"
Wire Introducer





ZARYAB
I N S T R U M E N T S

Products that saves life

Oral Maxillo Facial Surge



ZI-24-856-19
Terry
19cm 7 1/2"
Septal Osteotome



ZI-24-858-00
Terry
14cm 5 1/2"
Occlusal Wedge



ZI-24-859-01
Terry
15cm 6"
Duct Retractor left



ZI-24-859-02
Terry
15cm 6"
Duct Retractor right



ZARYAB
INSTRUMENTS

Products that saves life

Oral Maxillo Facial Surge



ZI-24-870-17
Turvey
17cm 6 3/4"
Palatal Expander



ZI-24-875-18
Steinhäuser
18.5cm 7 1/4"
Elevator



ZARYAB
I N S T R U M E N T S

Products that saves life

Oral Maxillo Facial Surge

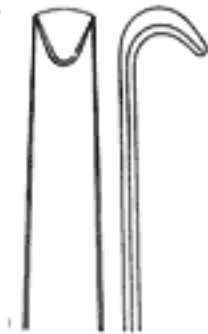

ZI-24-877-00
Steinhäuser
27cm 10 1/2"
Mandibular Retractor
extra long



ZARYAB
I N S T R U M E N T S

Products that saves life

Oral Maxillo Facial Surge

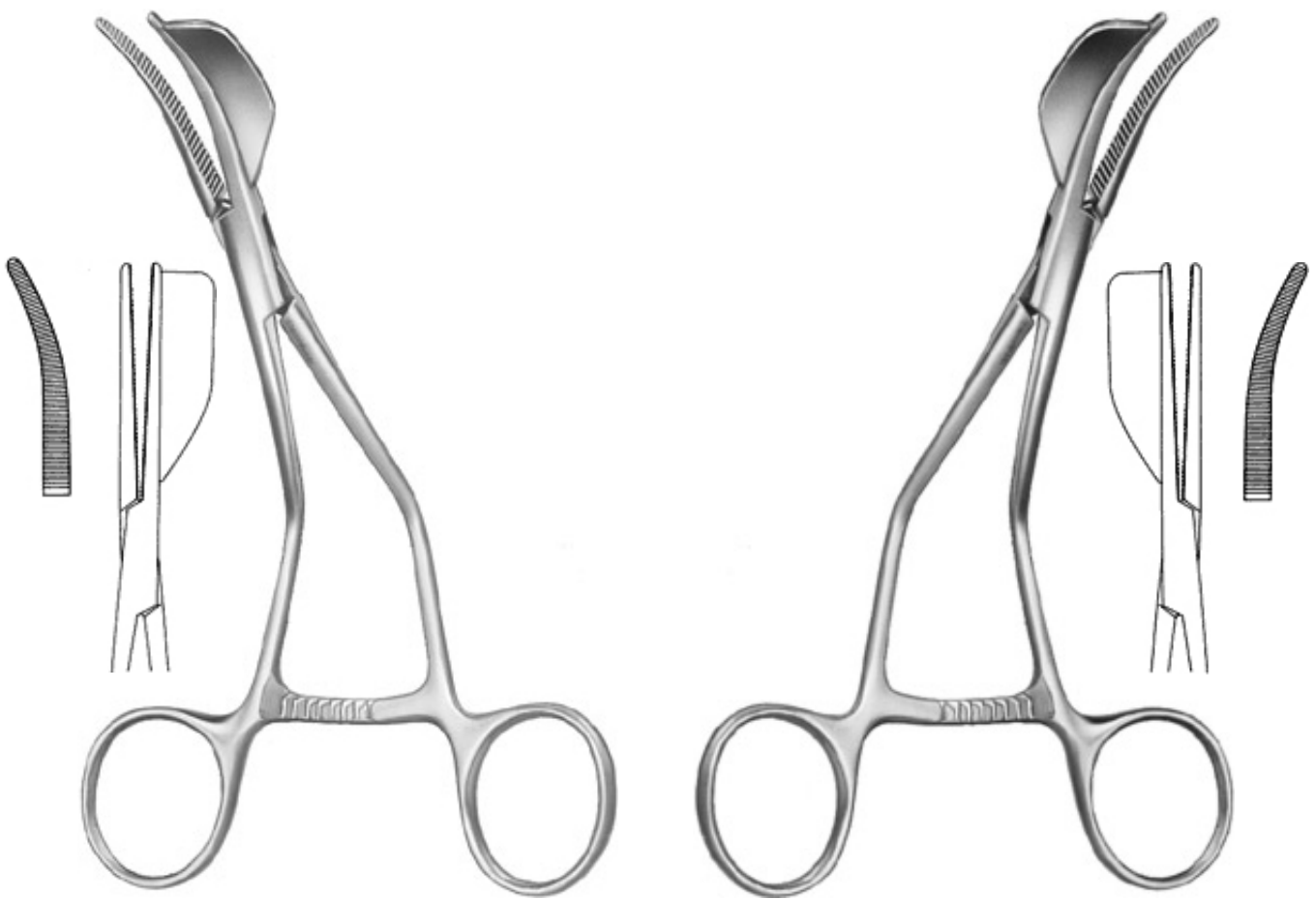

ZI-24-878-01
Steinhäuser
16cm 6 1/4"
Ramus Clamp right

ZI-24-878-02
Steinhäuser
16cm 6 1/4"
Ramus Clamp left



ZARYAB
I N S T R U M E N T S

Products that saves life

Oral Maxillo Facial Surge



ZI-24-881-07
Steinhäuser
17cm 6 3/4"
Ramus Osteotome
7 mm flexible



ZI-24-881-10
Steinhäuser
17cm 6 3/4"
Ramus Osteotome
10 mm flexible





ZARYAB
I N S T R U M E N T S

Products that saves life

Oral Maxillo Facial Surge



ZI-24-883-07
Steinhäuser
19cm 7 ½"
Chisel
7 mm flexible



ZI-24-883-11
Steinhäuser
19cm 7 ½"
Chisel
11 mm flexible



ZI-24-883-15
Steinhäuser
19cm 7 ½"
Chisel 15 mm
flexible





ZARYAB

INSTRUMENTS

Products that saves life

Oral Maxillo Facial Surge



ZI-38-885-18
Steinhäuser
18cm 7"
Reposition Instrument
Reposition Instrument



ZI-24-887-01
Steinhäuser
16cm 6 1/4"
Periosteal Elevator
6 x 12 mm



ZI-24-887-02
Steinhäuser
16.5cm 6 1/2"
Periosteal Elevator
6 x 19 mm



ZI-24-887-03
Steinhäuser
17cm 6 3/4"
Periosteal Elevator
6 x 26 mm





Oral Maxillo Facial Surge

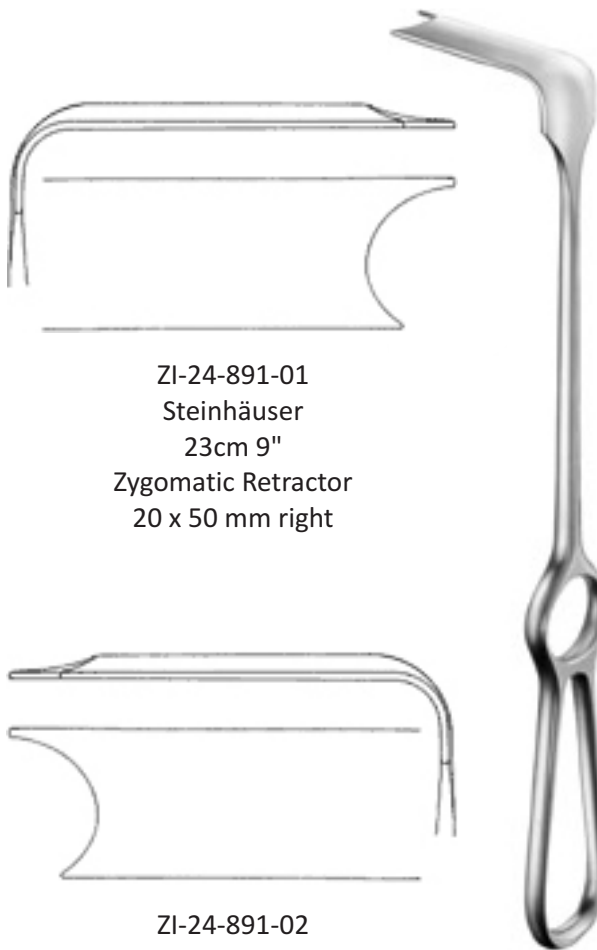

ZI-24-891-01
Steinhäuser
23cm 9"
Zygomatic Retractor
20 x 50 mm right

ZI-24-891-02
Steinhäuser
23cm 9"
Zygomatic Retractor
20 x 50 mm left



ZI-24-893-16
Steinhäuser
16.5cm 6 1/2"
Orbital Raspatory 3 mm



ZARYAB
I N S T R U M E N T S

Products that saves life

Oral Maxillo Facial Surge



ZI-24-895-05S
teinhäuser
18cm 7"
Orbital Osteotome
5 mm

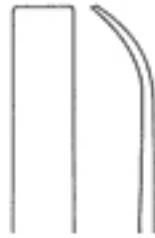

ZI-24-895-08
Steinhäuser
18cm 7"
Orbital Osteotome
8 mm





ZARYAB
I N S T R U M E N T S

Products that saves life

Oral Maxillo Facial Surge



ZI-24-899-06
Wolford
23cm 9"
Osteotome 6 mm



ZI-24-899-08
Wolford
23cm 9"
Osteotome 8 mm



Products that saves life

ZARYAB

I N S T R U M E N T S

 Harar, Wazirabad Road, Pir Sabz Rd, Pir Sabz, Sialkot-51310, Pakistan

 +92 52 3573775

 +92 52 3573776

 +92 333 8608580 , +92 333 3349600

 info@zaryabinstruments.com

 sales@zaryabinstruments.com

 www.zaryabinstruments.com