



*Products that saves life*

# ZARYAB

---

## INSTRUMENTS



## RHINOLOGY

### Catalogue





**ZARYAB**  
I N S T R U M E N T S

*Products that saves life*

## Rhinology



ZI-23-101-15  
Trölsch  
14.5cm 5 3/4"  
Nasal Tampon  
Forceps



ZI-23-105-18  
Trölsch  
18cm 7"  
Nasal Tampon  
Forceps





**ZARYAB**  
I N S T R U M E N T S

*Products that saves life*

## Rhinology



ZI-23-115-20  
Grünwald (Jansen)  
21.5cm 8 1/2"  
Nasal Tampon Forceps

ZI-23-129-20  
Lubet-Barbon  
18.5cm 7 1/4"  
Nasal Tampon Forceps  
Nasal Tampon Forceps



**ZARYAB**  
I N S T R U M E N T S

*Products that saves life*

## Rhinology



ZI-23-141-16  
Hartmann  
15cm 6"  
Nasal Polypus Forceps

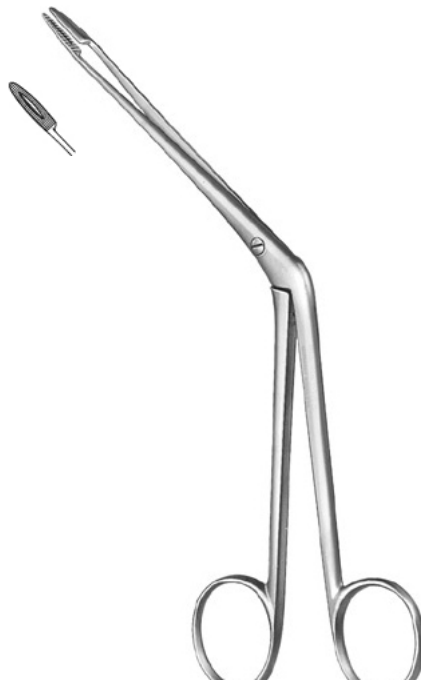

ZI-23-145-20  
Hartmann  
18.5cm 7 1/4"  
Nasal Polypus Forceps



ZI-23-161-17  
Killian  
16cm 6 1/4"  
Septum Forceps



**ZARYAB**  
I N S T R U M E N T S

*Products that saves life*

Rhinology

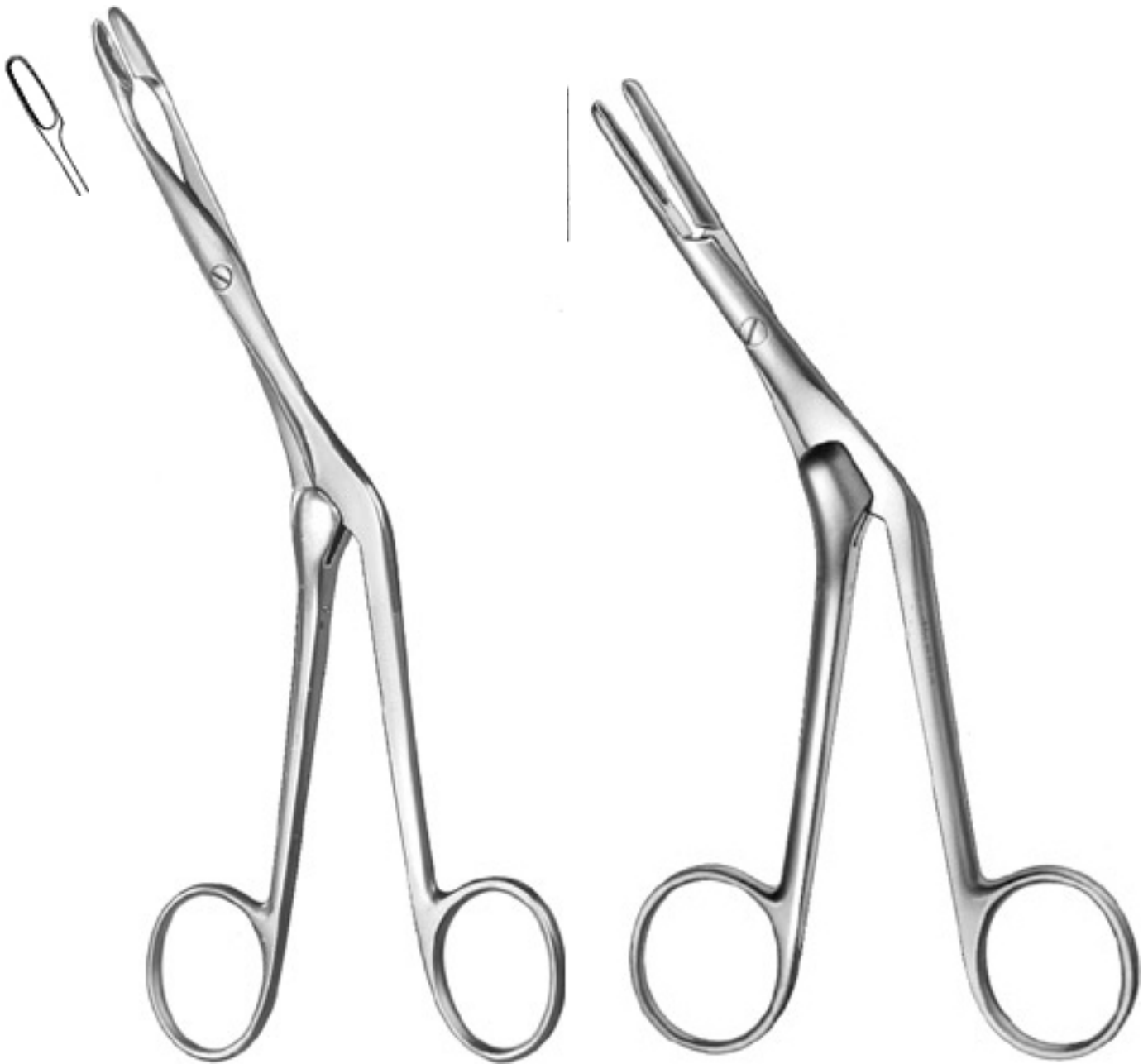

ZI-23-207-18  
Knight  
17cm 6 3/4"  
Septum Forceps

ZI-23-213-18  
Graig  
16cm 6 1/4"  
Septum Forceps



**ZARYAB**  
I N S T R U M E N T S

*Products that saves life*

## Rhinology



ZI-23-215-01  
16cm 6 1/4"  
Septum Forceps  
left curved



ZI-23-215-02  
16cm 6 1/4"  
Septum Forceps  
right curved



ZI-23-221-01  
Luc  
18.5cm 7 1/4"  
Ethmoid Bone  
Forceps  
Fig. 1



ZI-23-221-02  
Luc  
18.5cm 7 1/4"  
Ethmoid Bone  
Forceps  
Fig. 2



ZI-23-223-01  
Luc  
18.5cm 7 1/4"  
Ethmoid Bone  
Forceps  
Fig. 1



ZI-23-223-02  
Luc  
18.5cm 7 1/4"  
Ethmoid Bone  
Forceps  
Fig. 2





ZI-23-227-01  
Brünings  
16.5cm 6 1/2"  
Septum Forceps  
Fig. 1



ZI-23-227-02  
Brünings  
16.5cm 6 1/2"  
Septum Forceps  
Fig. 2



ZI-23-227-03  
Brünings  
16.5cm 6 1/2"  
Septum Forceps  
Fig. 3



ZI-23-227-04  
Brünings  
16.5cm 6 1/2"  
Septum Forceps  
Fig. 4







ZI-23-235-12  
Takahashi  
19cm 7 1/2"  
Ethmoid Bone Forceps  
shaft length 120 mm  
straight

ZI-23-237-12  
Takahashi  
19cm 7 1/2"  
Ethmoid Bone Forceps  
shaft length 120 mm  
bent upwards



ZI-23-241-10  
Watson-Williams  
19cm 7 1/2"  
Ethmoid Bone Forceps  
shaft length 120 mm

ZI-23-241-12  
Watson-Williams  
19cm 7 1/2"  
Ethmoid Bone Forceps  
shaft length 120 mm

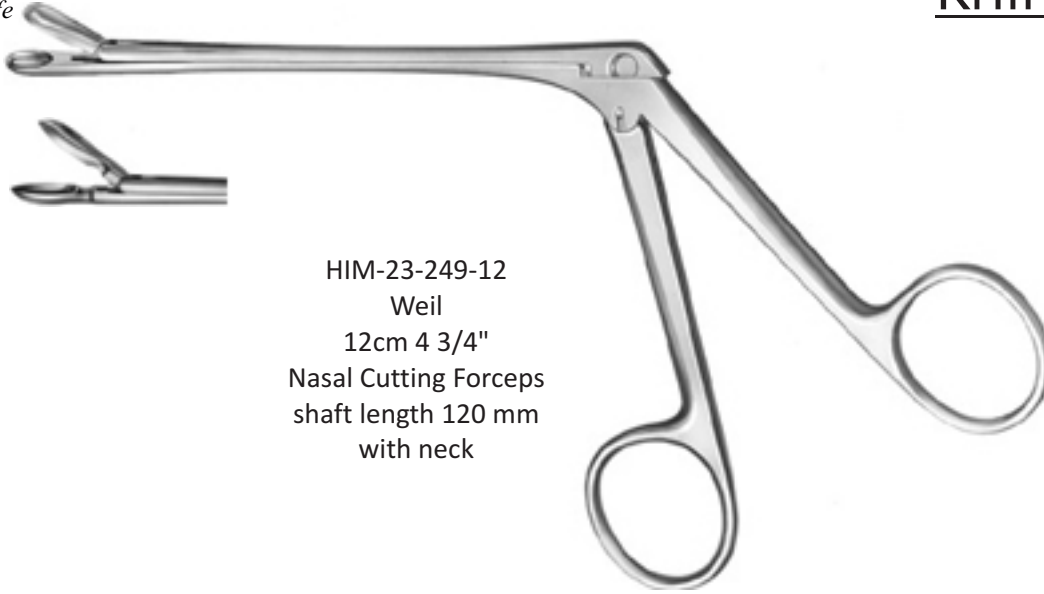

HIM-23-249-12  
Weil  
12cm 4 3/4"  
Nasal Cutting Forceps  
shaft length 120 mm  
with neck

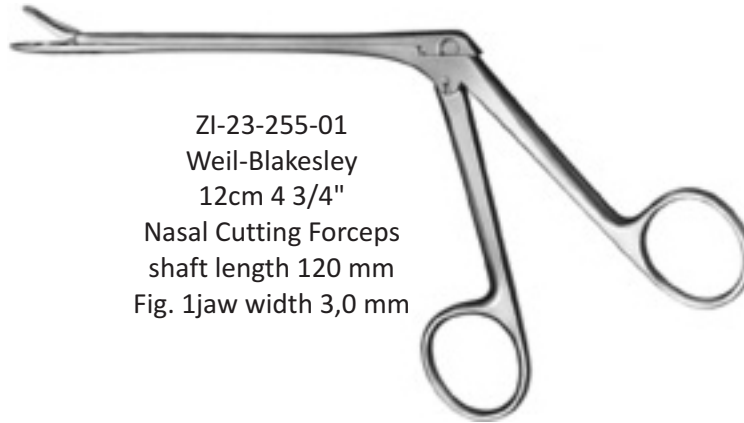

ZI-23-255-01  
Weil-Blakesley  
12cm 4 3/4"  
Nasal Cutting Forceps  
shaft length 120 mm  
Fig. 1jaw width 3,0 mm

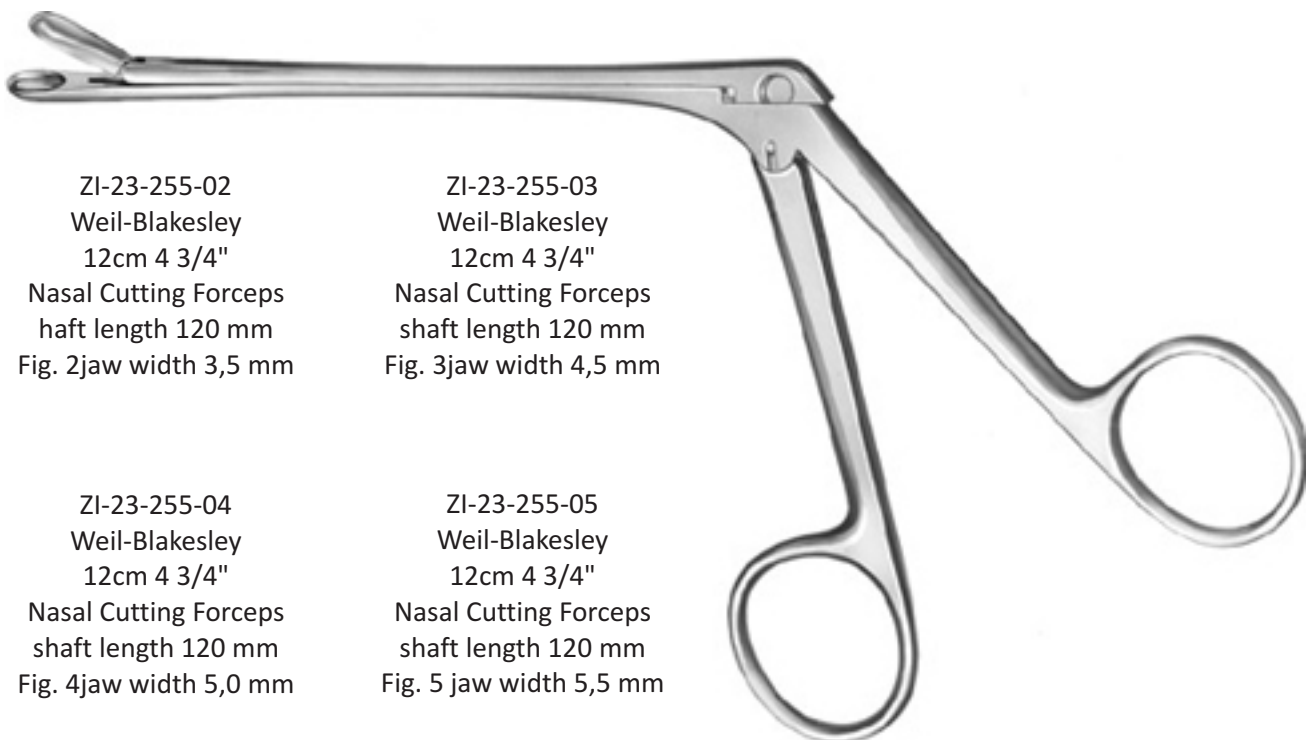

ZI-23-255-02  
Weil-Blakesley  
12cm 4 3/4"  
Nasal Cutting Forceps  
shaft length 120 mm  
Fig. 2jaw width 3,5 mm

ZI-23-255-03  
Weil-Blakesley  
12cm 4 3/4"  
Nasal Cutting Forceps  
shaft length 120 mm  
Fig. 3jaw width 4,5 mm

ZI-23-255-04  
Weil-Blakesley  
12cm 4 3/4"  
Nasal Cutting Forceps  
shaft length 120 mm  
Fig. 4jaw width 5,0 mm

ZI-23-255-05  
Weil-Blakesley  
12cm 4 3/4"  
Nasal Cutting Forceps  
shaft length 120 mm  
Fig. 5 jaw width 5,5 mm



ZI-23-256-01  
Weil-Blakesley  
Ethmoid Bone Forceps  
shaft length 120 mm  
Fig. 1  
jaw width 3,0 mm



ZI-23-256-02  
Weil-Blakesley  
Ethmoid Bone Forceps  
shaft length 120 mm  
Fig. 2  
jaw width 3,5 mm



ZI-23-256-03  
Weil-Blakesley  
Ethmoid Bone Forceps  
shaft length 120 mm  
Fig. 3  
jaw width 4,5 mm  
ZI-37-256-04



ZI-23-256-04  
Weil-Blakesley  
Ethmoid Bone Forceps  
shaft length 120 mm  
Fig. 4  
jaw width 5,0 mm



ZI-23-258-01  
Weil-Blakesley  
Ethmoid Bone Forceps  
shaft length 120 mm  
Fig. 1  
jaw width 3,0 mm



ZI-23-258-02  
Weil-Blakesley  
Ethmoid Bone Forceps  
shaft length 120 mm  
Fig. 2  
jaw width 3,5 mm



ZI-23-258-03  
Weil-Blakesley  
Ethmoid Bone Forceps  
shaft length 120 mm  
Fig. 3  
jaw width 4,5 mm



ZI-23-258-04  
Weil-Blakesley  
Ethmoid Bone Forceps  
shaft length 120 mm  
Fig. 4  
jaw width 5,0 mm





ZI-23-285-01  
Struycken  
19cm 4 3/4"  
Nasal Cutting Forceps  
shaft length 120 mm  
Fig. 1  
cut 0,9 mm

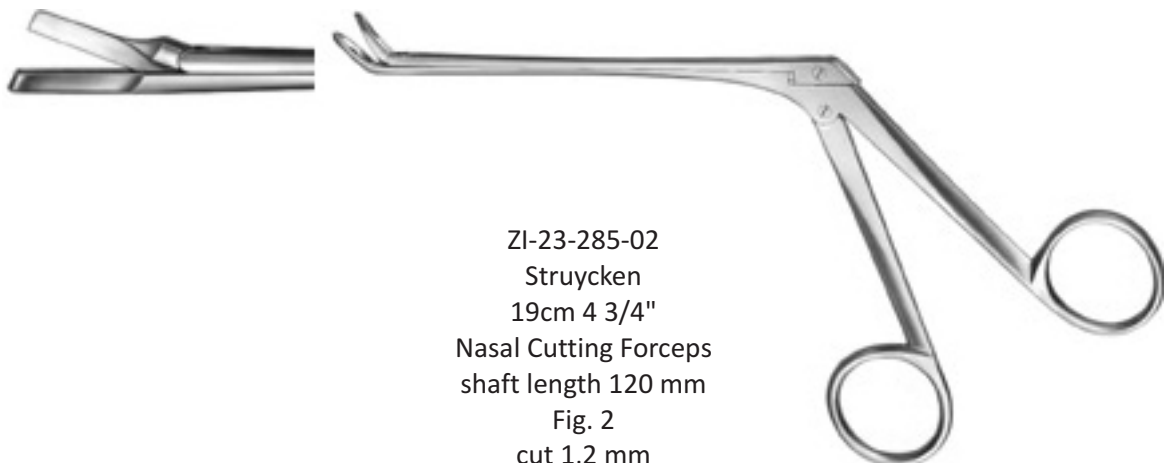

ZI-23-285-02  
Struycken  
19cm 4 3/4"  
Nasal Cutting Forceps  
shaft length 120 mm  
Fig. 2  
cut 1,2 mm

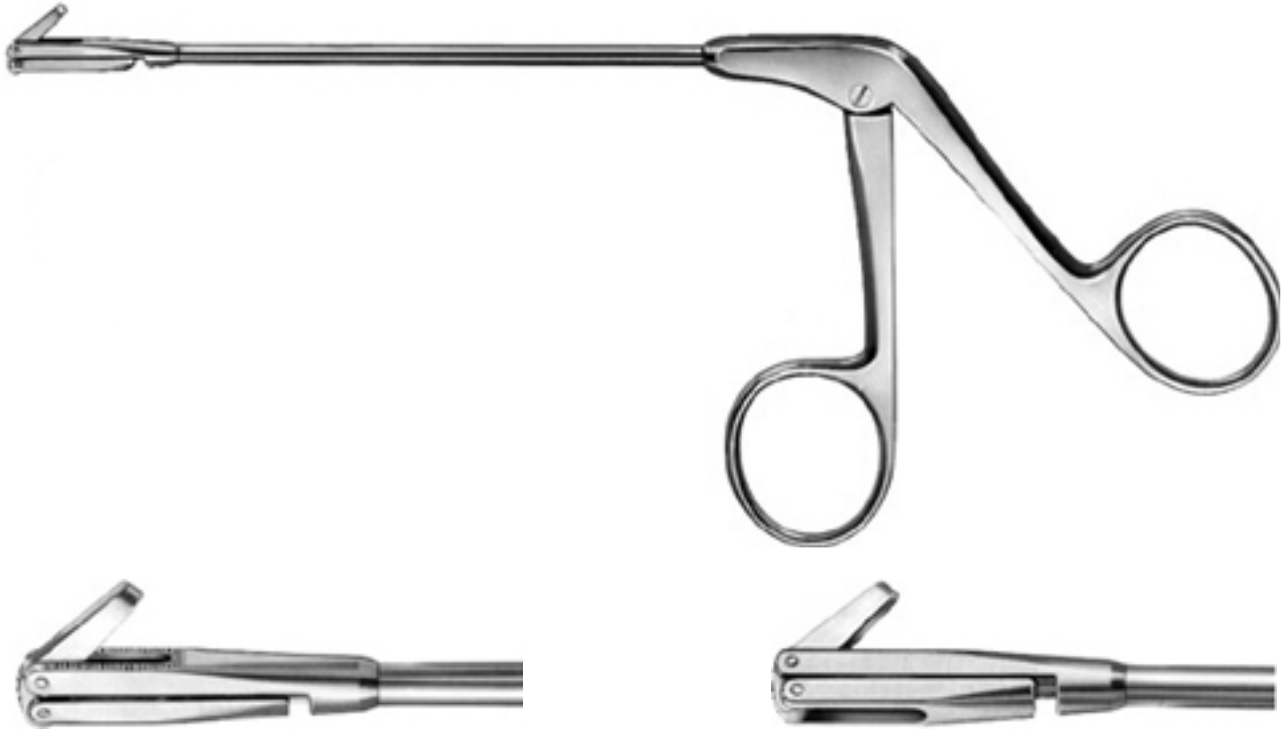

ZI-23-308-01  
Stammburger  
Antrum Punch  
up cutting 2 mm  
shaft length 100 mm  
Antrum Punchretrograde cut

ZI-23-308-02  
Stammburger  
Antrum Punch  
right cutting 2 mm  
shaft length 100 mm  
Antrum Punchretrograde cut



ZI-23-308-03  
Stammburger  
Antrum Punch  
left cutting 2 mm  
shaft length 100 mm  
Antrum Puncheretrograde cut



ZI-23-309-01  
Hartmann  
19cm 7 1/2"  
Nasal Cutting Forceps  
shaft length  
120 mm 5 mm Ø



ZI-23-309-02  
Hartmann  
19cm 7 1/2"  
Nasal Cutting Forceps  
shaft length  
120 mm 7 mm Ø



ZI-23-309-03  
Hartmann  
19cm 7 1/2"  
Nasal Cutting Forceps  
shaft length  
120 mm 9 mm Ø



ZI-23-309-04  
Hartmann  
19cm 7 1/2"  
Nasal Cutting Forceps  
shaft length  
120 mm 11 mm Ø



ZI-23-313-12  
Schmeden  
19cm 7 1/2"  
Nasal Cutting Forceps  
shaft length 120 mm  
jaw width 8,0 mm



ZI-23-323-19  
Middleton-Jansen  
19cm 7 1/2"  
Septum Forceps



ZI-23-327-19  
Middleton-Jansen  
19cm 7 1/2"  
Septum Forceps



ZI-23-331-20  
Caplan  
20cm 8"  
Septum Forceps  
one toothed cutting edge



ZI-23-335-01  
Rubin  
Protection Cap  
Protection Cap



ZI-23-335-21  
Rubin  
21cm 8 1/4"  
Septum Morselizer  
jaw width 4,6 mm





ZI-23-340-13  
Hajek  
14cm 5 1/2"

Sphenoid Bone Punch  
shaft length 140 mm  
up cutting  
cut 4 x 4 mm



ZI-23-341-13  
Hajek  
14cm 5 1/2"

Sphenoid Bone Punch  
shaft length 140 mm  
down cutting  
cut 4 x 4 mm



ZI-23-342-12  
Hajek-Kofler  
14cm 5 1/2"

Sphenoid Bone Punch  
shaft length 140 mm  
up cutting  
cut 3,5 x 3,5 mm



ZI-23-343-12  
Hajek-Kofler  
14cm 5 1/2"

Sphenoid Bone Punch  
shaft length 140 mm  
down cutting  
cut 3,5 x 3,5 mm



ZI-23-356-17  
Ferris-Smith-Kerrison  
18cm 7"  
Sphenoid Bone Punch  
shaft length 180 mm  
up cutting  
cut 3 x 3 mm

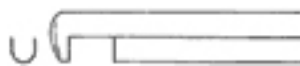

ZI-23-357-17  
Ferris-Smith-Kerrison  
18cm 7"  
Sphenoid Bone Punch  
shaft length 180 mm  
down cutting  
cut 3 x 3 mm

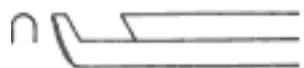
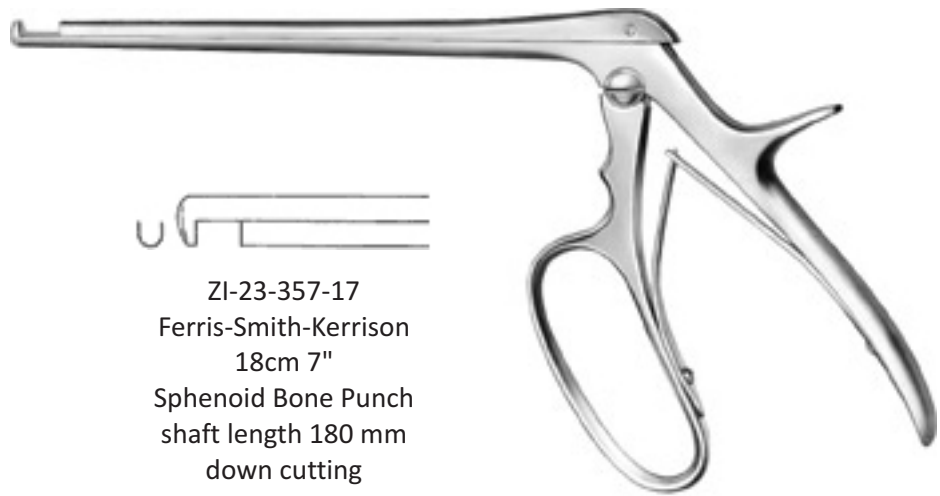

ZI-23-362-03  
Ferris-Smith-Kerrison  
18cm 7"  
Sphenoid Bone Punch  
shaft length 180 mm  
obliquely forward cutting  
bite 3,0 mm

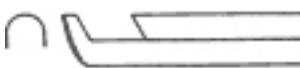

ZI-23-362-05  
Ferris-Smith-Kerrison  
18cm 7"  
Sphenoid Bone Punch  
shaft length 180 mm  
obliquely forward cutting  
bite 5,0 mm

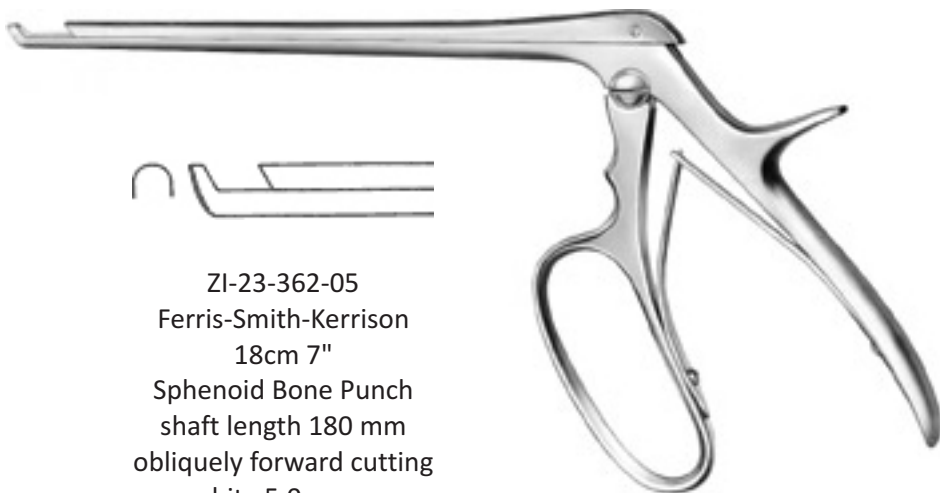

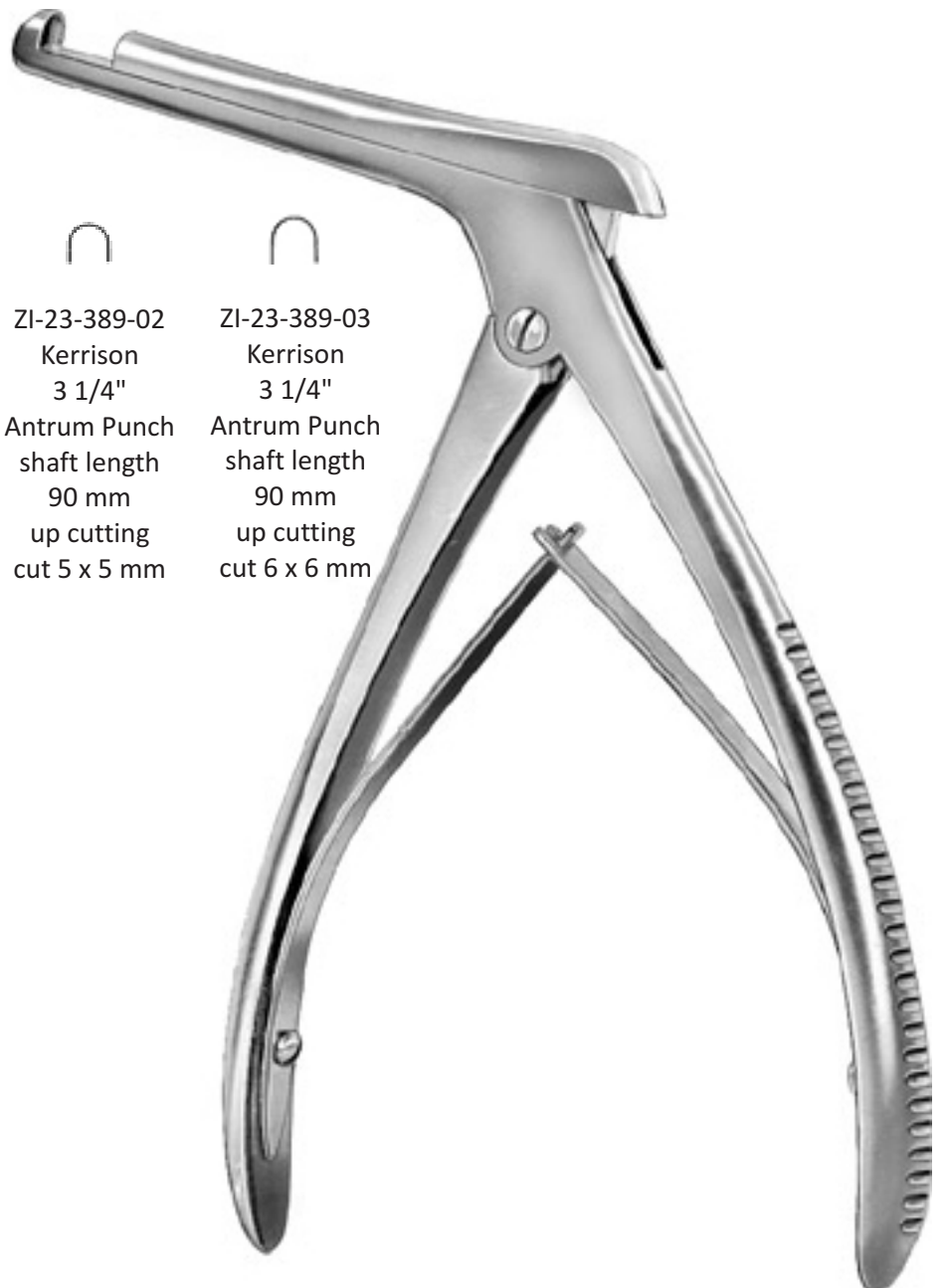

ZI-23-389-00  
Kerrison  
3 1/4"

ZI-23-389-01  
Kerrison  
3 1/4"

ZI-23-389-02  
Kerrison  
3 1/4"

ZI-23-389-03  
Kerrison  
3 1/4"

Antrum Punch  
shaft length  
90 mm  
up cutting  
cut 3 x 3 mm

Antrum Punch  
shaft length  
90 mm  
up cutting  
cut 4 x 4 mm

Antrum Punch  
shaft length  
90 mm  
up cutting  
cut 5 x 5 mm

Antrum Punch  
shaft length  
90 mm  
up cutting  
cut 6 x 6 mm



ZI-23-440-01  
Joseph  
15cm 6"  
Rhino  
plastic Knife  
Fig. 1



ZI-23-441-01  
Joseph  
15cm 6"  
Rhino  
plastic Knife  
Fig. 2



ZI-23-444-16  
Fomon  
16.5cm 6 1/2"  
Rhino  
plastic Knife



ZI-23-459-16  
Converse  
16cm 6 1/4"  
Rhino  
plastic Knife



## Rhinology



ZI-23-466-15  
Joseph  
15cm 6"  
Rhino plastic Knife



ZI-23-468-15  
Cottle  
14cm 5 1/2"  
Rhino plastic Knife



ZI-23-484-15  
Freer  
16.5cm 6 1/2"  
Mucosa Knife  
Mucosa Knife

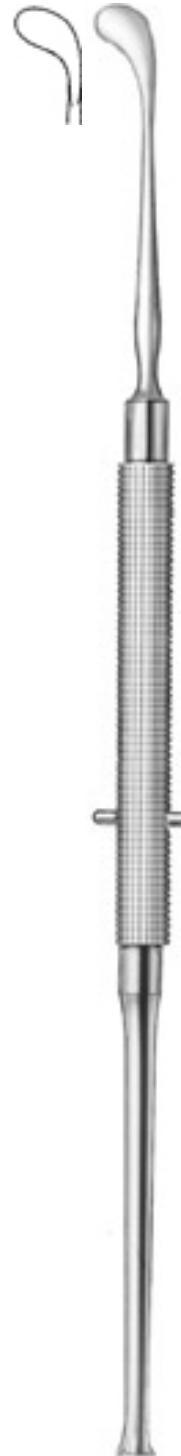

ZI-23-497-19  
Freer  
19cm 7 1/2"  
Septum Knife

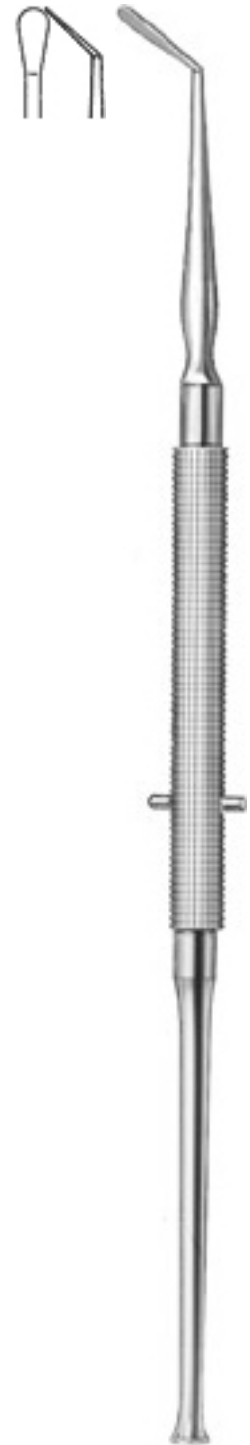

ZI-23-499-19  
Freer  
19cm 7 1/2"  
Septum Knife



## Rhinology



ZI-23-504-03  
Ballenger  
21cm 8 1/4"  
Swivel Knife  
cut 3,0 mm



ZI-23-504-04  
Ballenger  
21cm 8 1/4"  
Swivel Knife  
cut 4,0 mm



ZI-23-504-05  
Ballenger  
21cm 8 1/4"  
Swivel Knife  
cut 5,0 mm



ZI-23-505-03  
Ballenger  
20cm 8"  
Swivel Knife  
cut 3,0 mm



ZI-23-505-04  
Ballenger  
20cm 8"  
Swivel Knife  
cut 4,0 mm



ZI-23-505-05  
Ballenger  
20cm 8"  
Swivel Knife  
cut 5,0 mm





ZI-23-512-16  
Brünings  
16.5cm 6 1/2"  
Septum Knife  
Septum Knife



ZI-23-521-04  
McKenty  
15cm 6"  
Septum Elevator  
4 mm



ZI-23-521-05  
McKenty  
15cm 6"  
Septum Elevator  
5 mm



ZI-23-525-16  
Halle  
16cm 6 1/4"  
Septum Elevator  
3,5 mm



ZI-23-531-16  
Joseph  
16cm 6 1/4"  
Septum Elevator  
4 mm

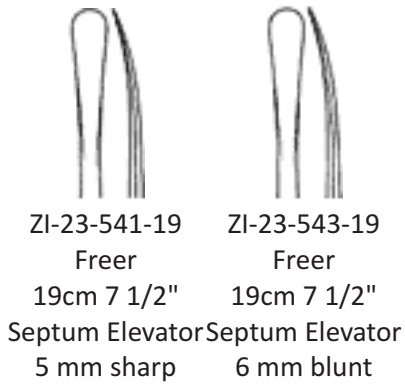

ZI-23-541-19      ZI-23-543-19  
Freer                  Freer  
19cm 7 1/2"      19cm 7 1/2"  
Septum Elevator    Septum Elevator  
5 mm sharp        6 mm blunt



ZI-23-546-18  
Freer  
18.5cm 7 1/4"  
Septum Elevator  
5 / 5 mm sharp / blunt

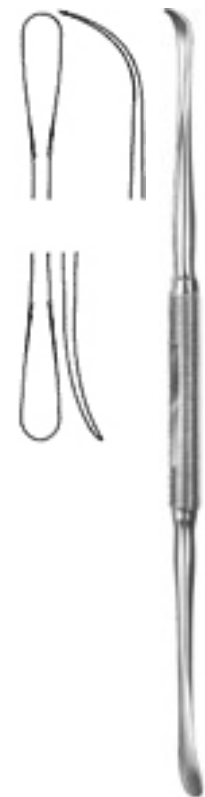
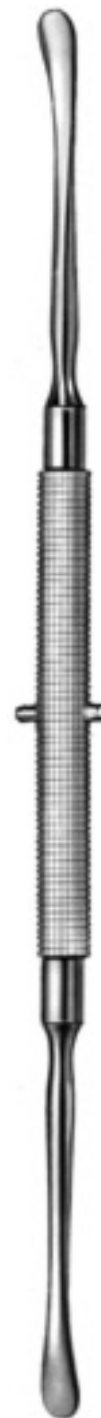

ZI-23-547-20  
Freer  
20.5cm 8"  
Septum Elevator  
6 / 5 mm



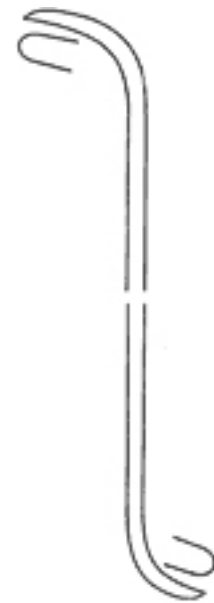

ZI-23-549-22  
McKenty  
20.5cm 8"  
Septum Elevator  
4 / 4 mm

ZI-23-550-19  
Ballenger-Hajek  
19cm 7 ½"  
Septum Elevator  
6 / 6 mm

ZI-23-559-23  
Cottle  
23.5cm 9 1/4"  
Septum Elevator  
5 / 5 mm

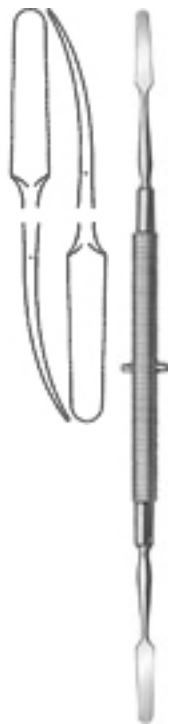

ZI-23-560-18  
Killian  
18cm 7"  
Septum Elevator  
4 / 4 mm



ZI-23-562-22  
Killian  
23cm 9"  
Septum Elevator  
4,5 / 4,5 mm

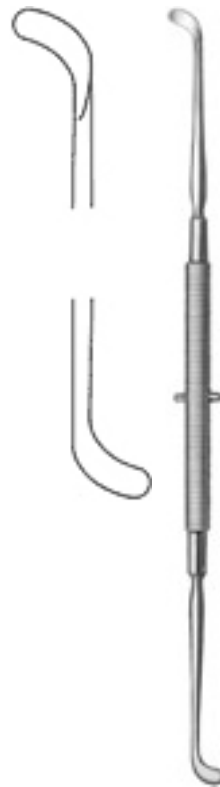

ZI-23-568-21  
Pennington  
21.5cm 8 1/2"  
Septum Elevator  
4 / 4 mm

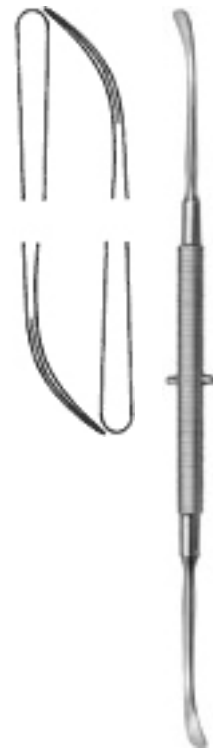

ZI-23-572-19  
Roger  
19.5cm 7 3/4"  
Septum Elevator  
4 / 4 mm

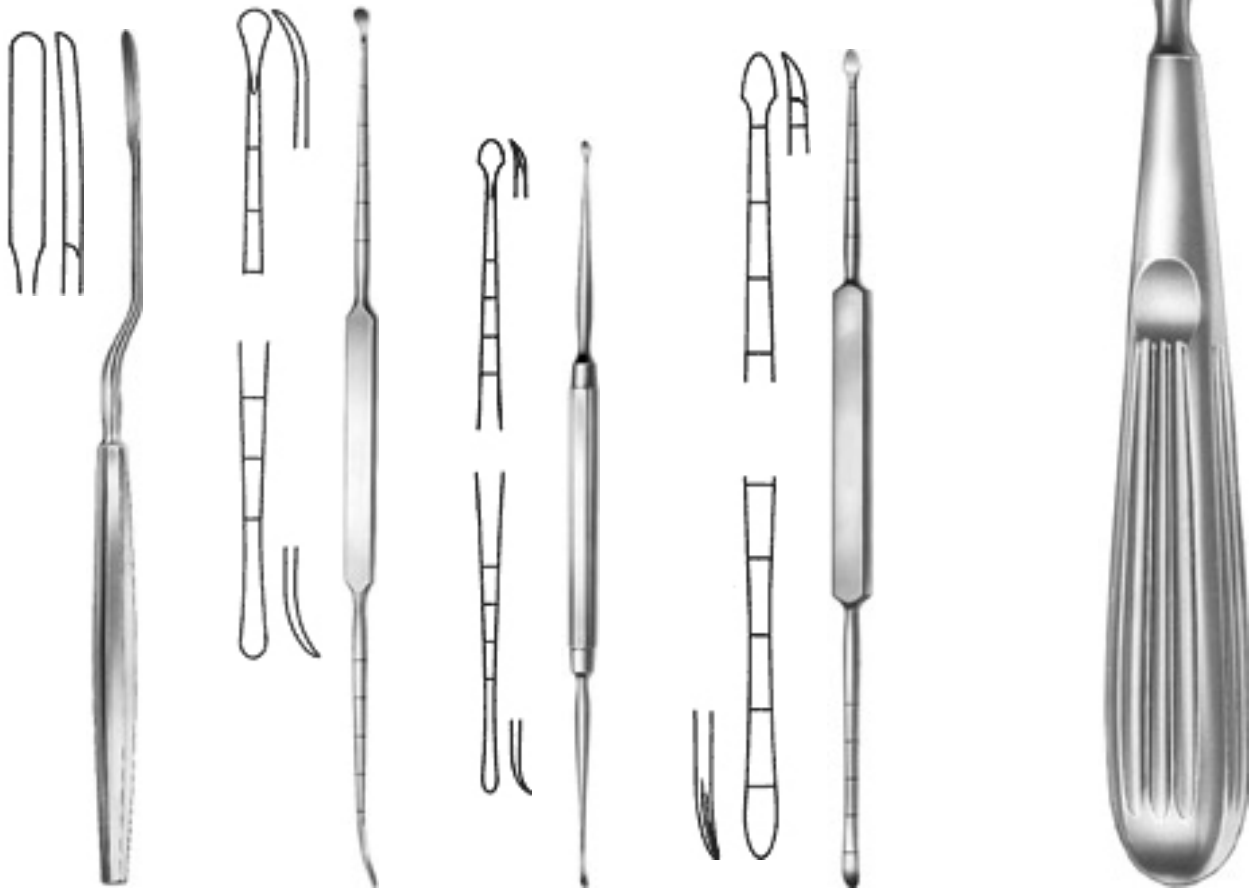

ZI-23-579-22  
Joseph-Masing  
21.5cm 8 1/2"  
Periosteal Elevator  
4 mm

ZI-23-581-22  
Cottle  
23cm 9"  
Septum Elevator  
3,3 / 3,7 mm

ZI-23-583-21  
Masing  
19.5cm 7 3/4"  
Periosteal Elevato  
r3 / 2 mm

ZI-23-584-21  
Cottle  
22cm 8 3/4"  
Periosteal Elevator  
4,5 / 4,5 mm

ZI-23-585-16  
Joseph  
18cm 7"  
Periosteal Elevator  
6,5 mm



ZI-23-593-16  
Freer  
16cm 6 1/4"  
Septum Chisel  
4 mm



ZI-23-594-16  
Freer  
16.5cm 6 1/2"  
Septum Chisel  
4 mm



ZI-23-595-15  
Freer  
15cm 6"  
Septum Gouge  
6 mm  
Septum Gouge



ZI-23-597-02  
Ballenger  
15cm 6"  
Septum Gouge  
2 mm



ZI-23-597-04  
Ballenger  
15cm 6"  
Septum Gouge  
4 mm



ZI-23-597-06  
Ballenger  
15cm 6"  
Septum Gouge  
6 mm



ZI-23-597-08  
Ballenger  
15cm 6"  
Septum Gouge  
8 mm



**ZARYAB**  
I N S T R U M E N T S

*Products that saves life*

## Rhinology



ZI-23-601-16  
Killian  
16cm 6 1/4"  
Septum Gouge  
5 mm



ZI-23-605-16  
Killian-Claus  
16cm 6 1/4"  
Septum Gouge  
5 mm



ZI-23-606-04  
Cottle  
18.5cm 7 1/4"  
Osteotome  
4 mm



ZI-23-606-07  
Cottle  
18.5cm 7 1/4"  
Osteotome  
7 mm



ZI-23-606-09  
Cottle  
18.5cm 7 1/4"  
Osteotome  
9 mm



ZI-23-606-12  
Cottle  
18.5cm 7 1/4"  
Osteotome  
12 mm



ZI-23-607-06  
Cottle  
18.5cm 7 1/4"  
Osteotome  
6 mm



ZI-23-608-02  
Cottle  
18.5cm 7 1/4"  
Osteotome  
2 mm



ZI-23-608-04  
Cottle  
18.5cm 7 1/4"  
Osteotome  
4 mm



ZI-23-608-07  
Cottle  
18.5cm 7 1/4"  
Osteotome  
7 mm



ZI-23-608-09  
Cottle  
18.5cm 7 1/4"  
Osteotome  
9 mm



ZI-23-608-12  
Cottle  
18.5cm 7 1/4"  
Osteotome  
12 mm





ZI-23-609-06  
Cottle  
18.5cm 7 1/4"  
Osteotome  
6 mm



ZI-23-610-16  
Cottle  
18.5cm 7 1/4"  
Osteotome  
16 mm



ZI-23-612-16  
Cottle  
18.5cm 7 1/4"  
Osteotome  
16 mm



ZI-23-616-10  
Rubin  
18.5cm 7 1/4"  
Osteotome  
10 mm



ZI-23-616-12  
Rubin  
18.5cm 7 1/4"  
Osteotome  
12 mm



ZI-23-616-14  
Rubin  
18.5cm 7 1/4"  
Osteotome  
14 mm



**ZARYAB**  
I N S T R U M E N T S

*Products that saves life*

Rhinology



ZI-23-620-03  
Walter  
19cm 7 ½"  
Gouge  
3 mm



ZI-23-620-04  
Walter  
19cm 7 ½"  
Gouge  
4,5 mm



ZI-23-622-03  
Walter  
19cm 7 ½"  
Osteotome  
3 mm



ZI-23-622-04  
Walter  
19cm 7 ½"  
Osteotome  
4 mm



ZI-23-622-07  
Walter  
19cm 7 ½"  
Osteotome  
7 mm



ZI-23-622-09  
Walter  
19cm 7 ½"  
Osteotome  
9 mm



ZI-23-622-12  
Walter  
19cm 7 ½"  
Osteotome  
12 mm



ZI-23-623-04  
Fomon  
16cm 6 1/4"  
Chisel  
4 mm



ZI-23-623-05  
Fomon  
16cm 6 1/4"  
Chisel  
5 mm



ZI-23-623-06  
Fomon  
16cm 6 1/4"  
Chisel  
6 mm



ZI-23-623-07  
Fomon  
16cm 6 1/4"  
Chisel  
7 mm

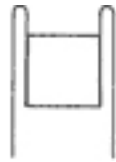

ZI-23-624-10  
Cinelli  
16cm 6 1/4"  
Osteotome  
10 mm

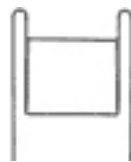

ZI-23-624-12  
Cinelli  
16cm 6 1/4"  
Osteotome  
12 mm

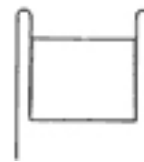

ZI-23-624-14  
Cinelli  
16cm 6 1/4"  
Osteotome  
14 mm

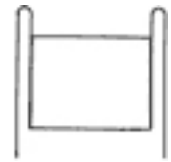

ZI-23-624-16  
Cinelli  
16cm 6 1/4"  
Osteotome  
16 mm



ZI-23-625-01  
Neivert-Anderson  
20.5cm 8"  
Osteotome  
7 mm



ZI-23-625-02  
Neivert-Anderson  
20.5cm 8"  
Osteotome  
7 mm



ZI-23-625-03  
Neivert-Anderson  
20.5cm 8"  
Osteotome  
7 mm



ZI-23-626-01  
Sheehan  
15cm 6"  
Osteotome  
1 mm



ZI-23-626-02  
Sheehan  
15cm 6"  
Osteotome  
2 mm



ZI-23-626-03  
Sheehan  
15cm 6"  
Osteotome  
3 mm



ZI-23-626-04  
Sheehan  
15cm 6"  
Osteotome  
4 mm



ZI-23-626-05  
Sheehan  
15cm 6"  
Osteotome  
5 mm



ZI-23-626-06  
Sheehan  
15cm 6"  
Osteotome  
6 mm



ZI-23-626-07  
Sheehan  
15cm 6"  
Osteotome  
7 mm



ZI-23-626-08  
Sheehan  
15cm 6"  
Osteotome  
8 mm



ZI-23-626-10  
Sheehan  
15cm 6"  
Osteotome  
10 mm



ZI-23-626-12  
Sheehan  
15cm 6"  
Osteotome  
12 mm





ZI-23-628-01  
Silver  
18cm 7"  
Rhinoplastic Chisel  
5 mm straight



ZI-23-628-02  
Silver  
18cm 7"  
Rhinoplastic Chisel  
5 mm right



ZI-23-628-03  
Silver  
18cm 7"  
Rhinoplastic Chisel  
5 mm left



**ZARYAB**  
I N S T R U M E N T S

*Products that saves life*

## Rhinology

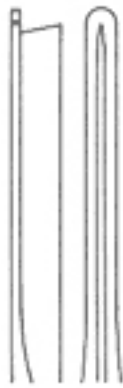

ZI-23-629-01  
Parkes  
16cm 6 1/4"  
Osteotome



**ZARYAB**  
I N S T R U M E N T S

*Products that saves life*

## Rhinology

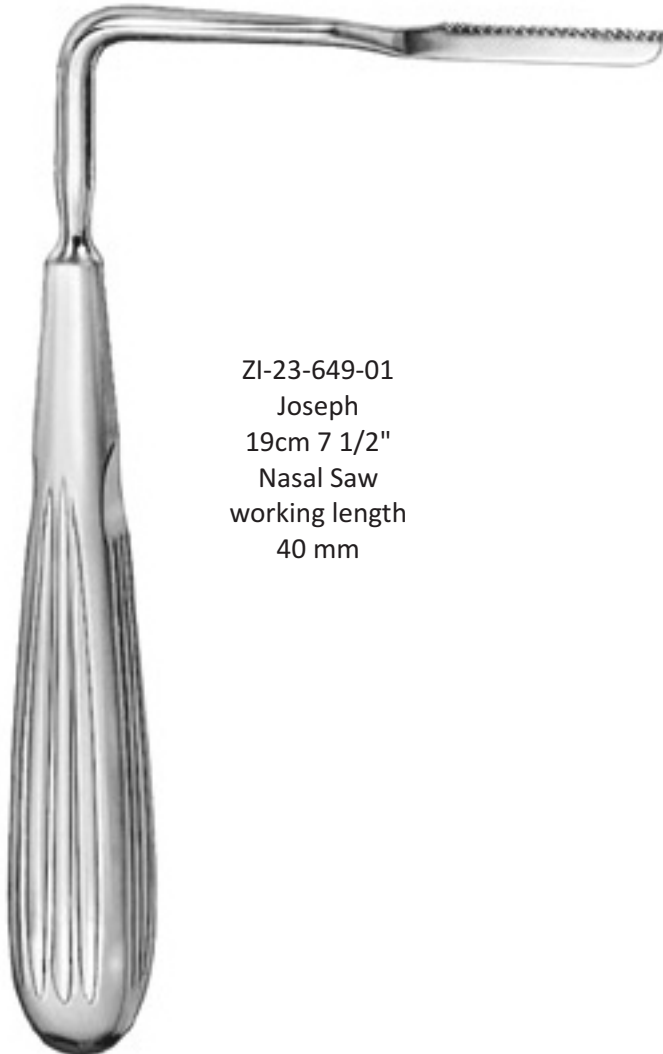

ZI-23-649-01  
Joseph  
19cm 7 1/2"  
Nasal Saw  
working length  
40 mm

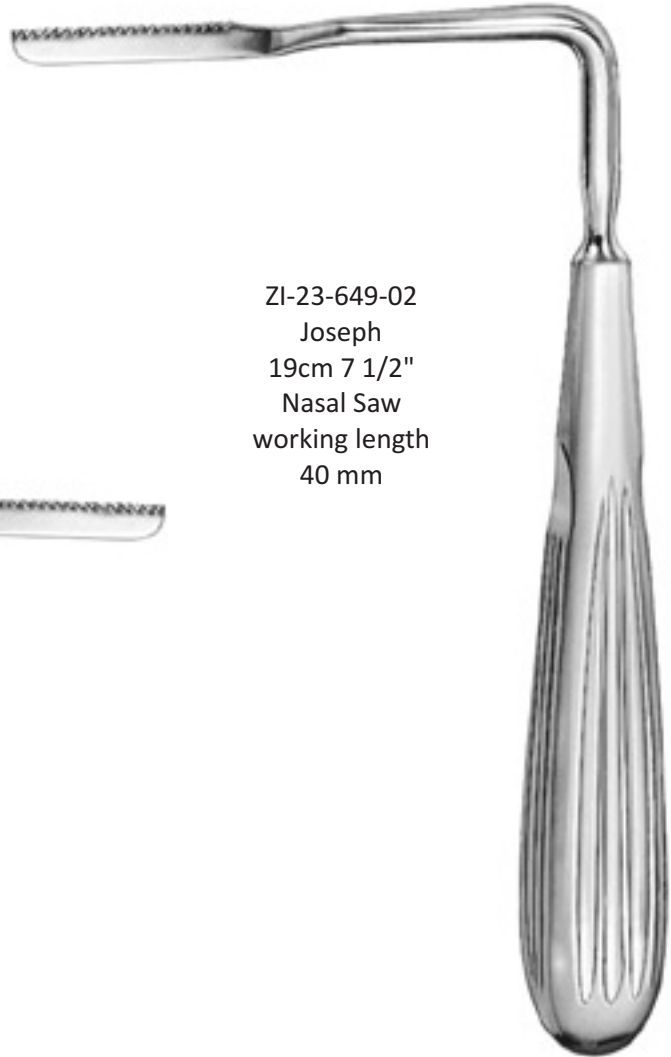

ZI-23-649-02  
Joseph  
19cm 7 1/2"  
Nasal Saw  
working length  
40 mm



ZI-23-631-20  
Joseph  
17cm 6 3/4"  
Nasal Sawang  
led to left



ZI-23-633-20  
Joseph  
17cm 6 3/4"  
Nasal Sawang  
led to right



ZI-23-649-00  
Joseph  
19cm 7 1/2"  
Nasal Saw  
working length 40 mm





ZI-23-650-01  
Cottle  
12cm 4 3/4"  
T-Handle  
Handle



ZI-23-650-02  
Cottle  
Guide Support  
7 mm wide  
Guide Support  
for osteotomes



ZI-23-652-00  
Cottle  
Cartilage Crusher  
65 x 30 x 30 mm  
Cartilage Crusher

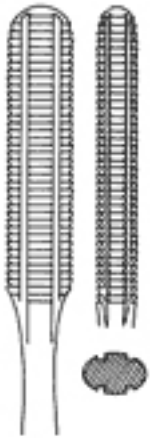

ZI-23-654-18  
Maltz  
17.5cm 7"  
Nasal Rasp  
40 x 9 mm

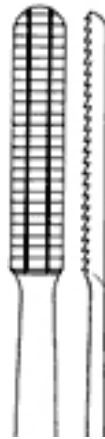

ZI-23-656-01  
Maltz  
17cm 6 3/4"  
Nasal Rasp  
drawing cut  
34 x 7 mm

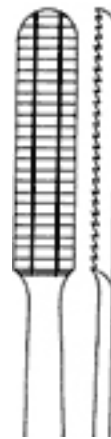

ZI-23-656-02  
Maltz  
17cm 6 3/4"  
Nasal Rasppu  
shing cut  
34 x 7 mm





ZI-23-658-01  
Joseph  
16cm 6 1/4"  
Bone File  
60 x 8 mm



ZI-23-658-02  
Joseph  
16cm 6 1/4"  
Bone File  
45 x 9 mm



ZI-23-669-01  
Gallaher  
17cm 6 3/4"  
Antrum Rasp  
45 x 6 mm



ZI-23-669-02  
Gallaher  
17cm 6 3/4"  
Antrum Rasp  
45 x 6 mm



ZI-23-669-03  
Gallaher  
17cm 6 3/4"  
Antrum Rasp  
45 x 6 mm





**ZARYAB**  
I N S T R U M E N T S

*Products that saves life*

## Rhinology

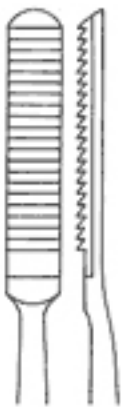

ZI-23-670-21  
Cottle  
20.5cm 8"  
Nasal Rasp  
30 x 8 mm

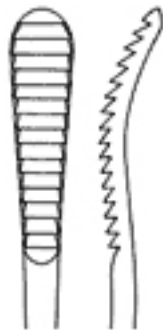

ZI-23-671-21  
Aufricht  
21cm 8 1/4"  
Glabella Rasp  
pushing cut  
32 x 9 mm

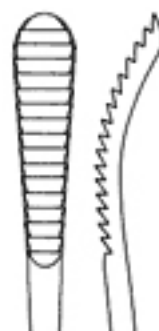

ZI-23-673-21  
Aufricht  
21cm 8 1/4"  
Glabella Rasp  
drawing cut  
32 x 9 mm

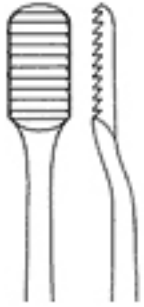

ZI-23-674-18  
Lewis  
19cm 7 1/2"  
Nasal Rasp  
drawing cut  
15 x 8 mm  
fine

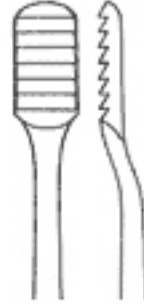

ZI-23-676-18  
Lewis  
19cm 7 1/2"  
Nasal Rasp  
drawing cut  
15 x 8 mm  
coarse



**ZARYAB**  
I N S T R U M E N T S

*Products that saves life*

## Rhinology

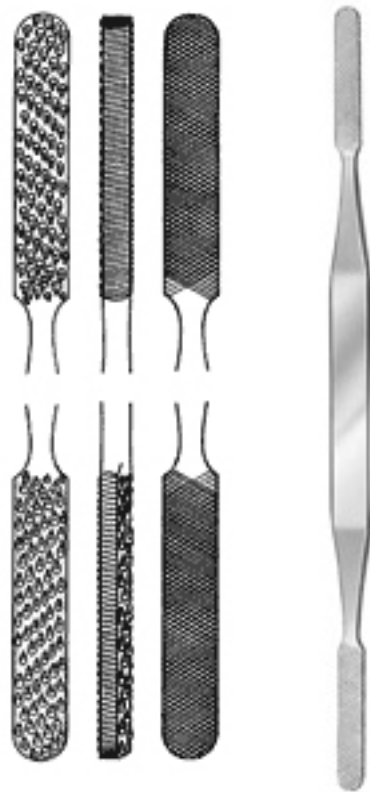

ZI-23-680-21

Fomon

20.5cm 8"

Bone File

30 x 8 mm



ZI-23-682-01  
Fomon  
20.5cm 8"  
Nasal Rasp

Fig. 1 / 230 x 8 mm  
not available  
in the USA

ZI-23-682-02  
Fomon  
20.5cm 8"  
Nasal Rasp

Fig. 3 / 440 x 7 mm  
not available  
in the USA

ZI-23-682-03  
Fomon  
20.5cm 8"  
Nasal Rasp

Fig. 5 / 640 x 7 mm  
not available  
in the USA

ZI-23-682-04  
Fomon  
20.5cm 8"  
Nasal Rasp

Fig. 7 / 840 x 7 mm  
not available  
in the USA

ZI-23-682-05  
Fomon  
20.5cm 8"  
Nasal Rasp

Fig. 9 / 1040 x 7 mm  
not available  
in the USA

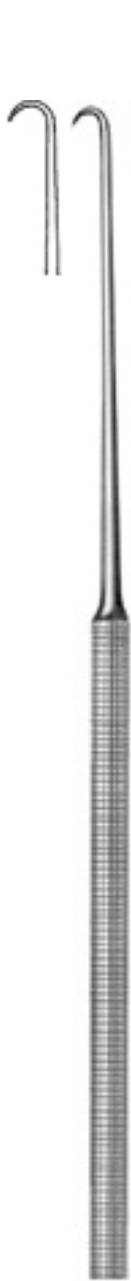

ZI-23-684-15  
Joseph  
15.5cm 6"  
Mucosa Hook  
let sharp  
Mucosa Hooklet



ZI-23-686-16  
Cottle  
17cm 6 3/4"  
Nasal Hook sharp



ZI-23-688-01  
Cottle  
14.5cm 5 3/4"  
Nasal Hook  
sharp



ZI-23-688-02  
Cottle  
14.5cm 5 3/4"  
Nasal Hook  
sharp



ZI-23-688-03  
Cottle  
14.5cm 5 3/4"  
Nasal Hook  
sharp



**ZARYAB**  
I N S T R U M E N T S

*Products that saves life*

## Rhinology



ZI-23-692-22  
Lange  
23cm 9"  
Alar Hooklet  
button end  
Alar Hooklet



ZI-23-693-01  
Converse  
9cm 3 1/2"  
Nasal Retractor  
18 x 9,5 mm



ZI-23-693-02  
Converse  
9cm 3 1/2"  
Nasal Retractor  
28 x 12,5 mm

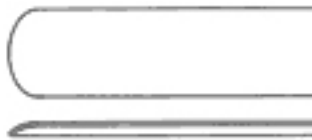

ZI-23-693-03  
Converse  
9cm 3 1/2"  
Nasal Retractor  
41 x 13,5 mm

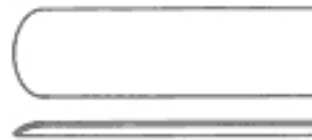

ZI-23-693-04  
Converse  
9cm 3 1/2"  
Nasal Retractor  
53 x 13,5 mm





ZI-23-694-17  
Fomon  
17cm 6 3/4"  
Alar Hooklet  
button end  
Alar Hooklet



ZI-23-697-19  
Aufricht  
19cm 7 1/2"  
Nasal Retractor  
blade  
40 x 12 mm



ZI-23-698-10  
Kilner  
8cm 3 1/4"  
Alar Hooklet  
sharp Alar Hooklet



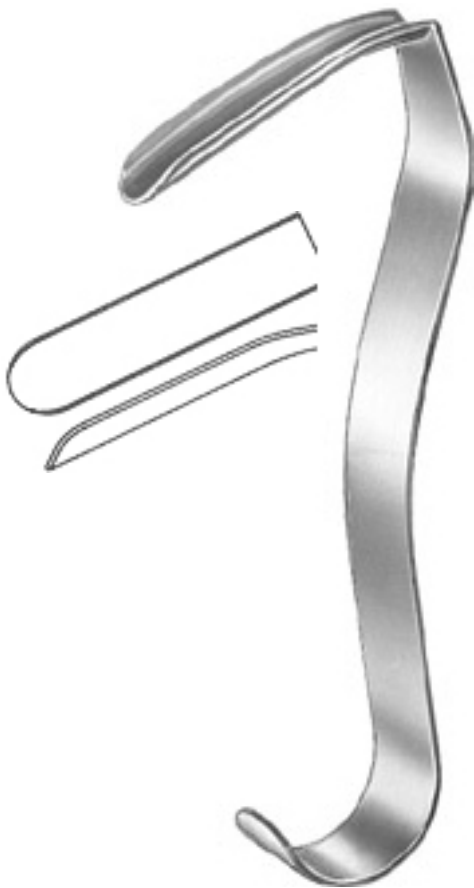

ZI-23-699-11  
Converse  
10.5cm 4"  
Nasal Retractor  
blade  
44 x 11 mm



ZI-23-700-12  
Converse  
11.5cm 4 1/2"  
Alar Hooklet  
sharp Alar Hooklet



ZI-23-702-15  
Freer  
15cm 6"  
Mucosa Hooklet  
sharp



ZI-23-704-02  
Joseph  
16.5cm 6 1/2"  
Mucosa Hooklet  
2 mm



ZI-23-704-05  
Joseph  
16.5cm 6 1/2"  
Mucosa Hooklet  
5 mm



ZI-23-704-07  
Joseph  
16.5cm 6 1/2"  
Mucosa Hooklet  
7 mm



ZI-23-704-10  
Joseph  
16.5cm 6 1/2"  
Mucosa Hooklet  
10 mm



**ZARYAB**  
I N S T R U M E N T S

*Products that saves life*

## Rhinology



ZI-23-706-16  
Fomon  
16cm 6 1/4"  
Alar Hooklet  
button ended

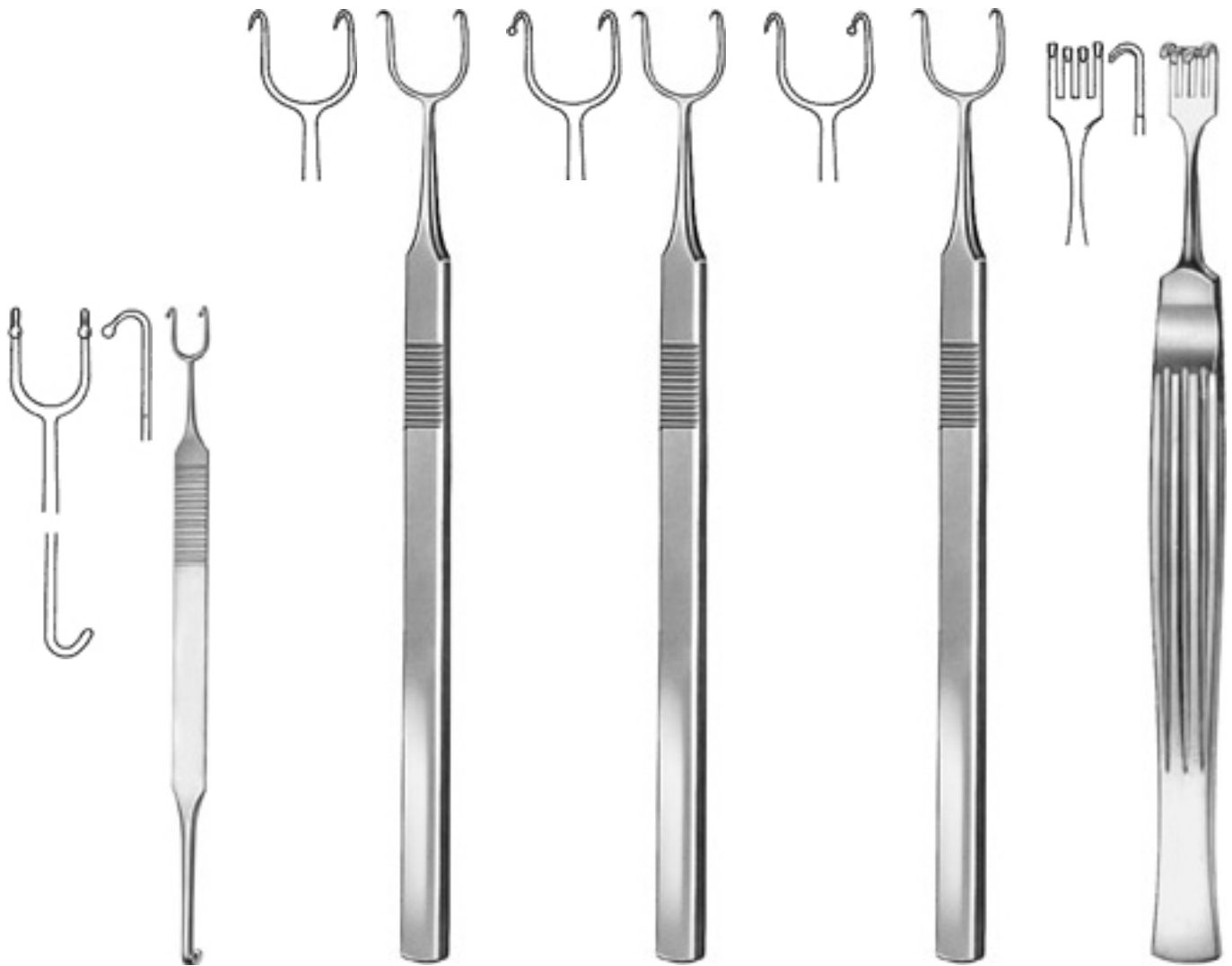

ZI-23-707-20  
Cottle-Neivert  
19.5cm 7 3/4"  
Alar Hooklet

ZI-23-708-14  
Cottle  
14.5cm 5 3/4"  
Alar Hooklet  
sharp

ZI-23-709-01  
Cottle  
14.5cm 5 3/4"  
Alar Hooklet  
blunt / sharp

ZI-23-709-02  
Cottle  
14.5cm 5 3/4"  
Alar Hooklet  
sharp / blunt

ZI-23-710-14  
Cottle  
14cm 5 1/2"  
Nasal Retractor

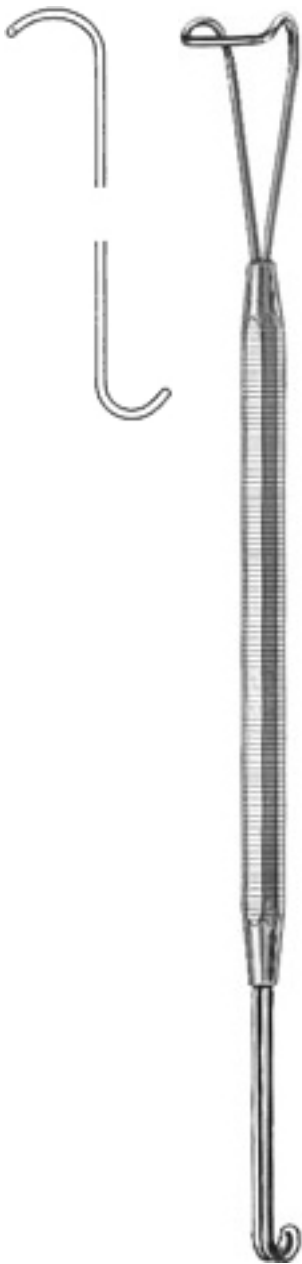

ZI-23-712-16  
Neivert  
17cm 6 3/4"  
Alar Hooklet



ZI-23-713-15  
Cottle  
14cm 5 1/2"  
Saddle Hook  
Saddle Hook



ZI-23-714-15  
Cottle  
16cm 6 1/4"  
Alar Hooklet



ZI-23-715-14  
Aufricht  
12cm 4 3/4"  
Nasal Retractor  
blade 60 x 6,5 mm  
blunt



ZI-23-721-20  
Kressner  
21cm 8 1/4"  
Septum Forceps



ZI-23-724-01  
Cottle-Walsham  
23cm 9"  
Septum  
Straightening  
Forceps straight



ZI-23-724-02  
Cottle-Walsham  
23cm 9"  
Septum  
Straightening  
Forceps left



ZI-23-724-03  
Cottle-Walsham  
23cm 9"  
Septum  
Straightening  
Forceps right



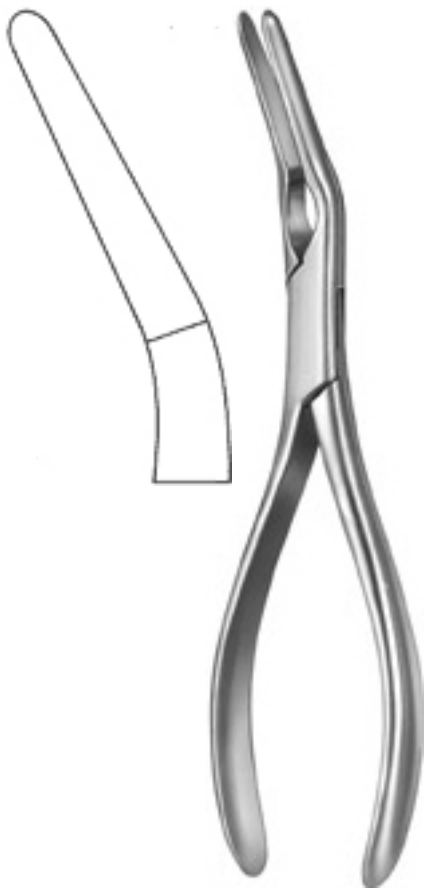

ZI-23-725-23  
Asch  
22.5cm 8 3/4"  
Septum Straightening  
Forceps



ZI-23-727-15  
Aiach  
15.5cm 6"  
Columella Suturing  
Forceps  
5 mm wide  
Columella  
Suturing Forceps















ZI-23-728-11  
Ogura  
11cm 4 1/4"  
Skin Grasping  
Forceps  
4 mm wide



ZI-23-731-14  
Cottle  
14cm 5 1/2"  
Skin Grasping  
Forceps  
1,7 mm wide  
with teeth



					
ZI-23-755-01	ZI-23-755-02	ZI-23-755-03	ZI-23-755-04	ZI-23-755-05	ZI-23-755-06
Beckmann	Beckmann	Beckmann	Beckmann	Beckmann	Beckmann
22.5cm 8 3/4"	22.5cm 8 3/4"	22.5cm 8 3/4"	22.5cm 8 3/4"	22.5cm 8 3/4"	22.5cm 8 3/4"
Adenoid Curette	Adenoid Curette	Adenoid Curette	Adenoid Curette	Adenoid Curette	Adenoid Curette
Fig. 1	Fig. 2	Fig. 3	Fig. 4	Fig. 5	Fig. 6
13 mm	15 mm	17 mm	19 mm	21 mm	23 mm

						
ZI-23-756-01	ZI-23-756-02	ZI-23-756-03	ZI-23-756-04	ZI-23-756-05	ZI-23-756-06	
Beckmann	Beckmann	Beckmann	Beckmann	Beckmann	Beckmann	
22cm 8 3/4"	22cm 8 3/4"	22cm 8 3/4"	22cm 8 3/4"	22cm 8 3/4"	22cm 8 3/4"	
Adenoid Curette	Adenoid Curette	Adenoid Curette	Adenoid Curette	Adenoid Curette	Adenoid Curette	
Fig. 1	Fig. 2	Fig. 3	Fig. 4	Fig. 5	Fig. 6	
13 mm	15 mm	17 mm	19 mm	21 mm	23 mm	
angled shaft	angled shaft	angled shaft	angled shaft	angled shaft	angled shaft	





ZI-23-759-01  
Beckmann  
22.5cm 8 3/4"  
Adenoid Curette  
Fig. 1  
16 mm  
trapezoidal fene  
strated



ZI-23-759-02  
Beckmann  
22.5cm 8 3/4"  
Adenoid Curette  
Fig. 2  
17 mm  
trapezoidal fene  
strated



ZI-23-759-03  
Beckmann  
22.5cm 8 3/4"  
Adenoid Curette  
Fig. 3  
18 mm  
trapezoidal fene  
strated



ZI-23-759-04  
Beckmann  
22.5cm 8 3/4"  
Adenoid Curette  
Fig. 4  
20 mm  
trapezoidal fene  
strated



ZI-23-759-05  
Beckmann  
22.5cm 8 3/4"  
Adenoid Curette  
Fig. 5  
21 mm  
trapezoidal fene  
strated

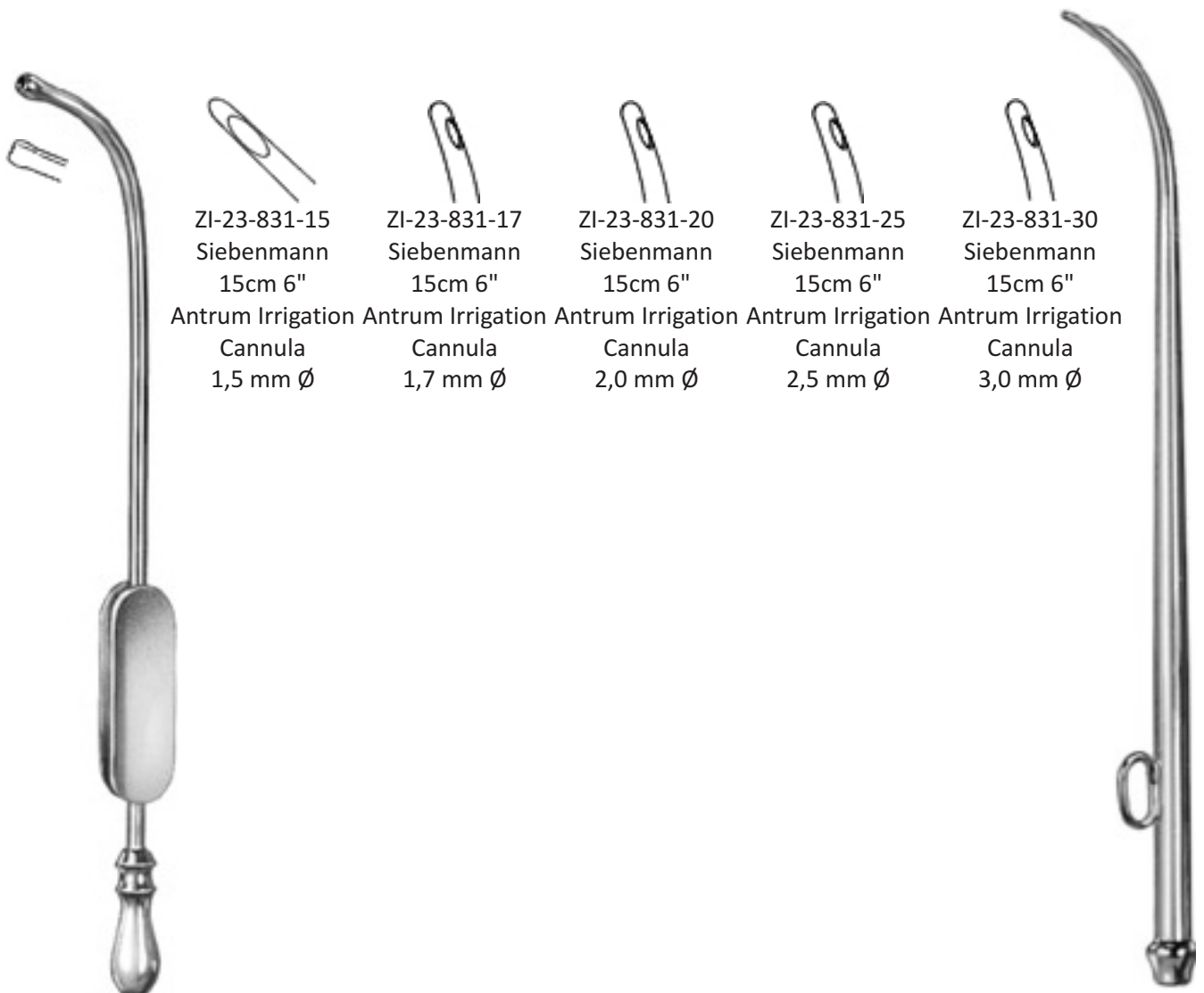

ZI-23-831-15  
Siebenmann  
15cm 6"

ZI-23-831-17  
Siebenmann  
15cm 6"

ZI-23-831-20  
Siebenmann  
15cm 6"

ZI-23-831-25  
Siebenmann  
15cm 6"

ZI-23-831-30  
Siebenmann  
15cm 6"

Antrum Irrigation Cannula    Antrum Irrigation Cannula    Antrum Irrigation Cannula    Antrum Irrigation Cannula    Antrum Irrigation Cannula

1,5 mm Ø

1,7 mm Ø

2,0 mm Ø

2,5 mm Ø

3,0 mm Ø

ZI-23-815-30  
Eicken-Killian  
14cm 5 1/2"  
Antrum Irrigation  
Cannula  
3 mm Ø  
Irrigation Cannula



ZI-23-840-20  
Guilen  
19cm 7 1/2"  
Suction Raspatory



ZI-23-841-25  
Ritter-Halle  
14.5cm 5 3/4"  
Frontal Sinus  
Dilator  
2,5 mm Ø



ZI-23-841-30  
Ritter-Halle  
14.5cm 5 3/4"  
Frontal Sinus  
Dilator  
3,0 mm Ø



ZI-23-841-40  
Ritter-Halle  
14.5cm 5 3/4"  
Frontal Sinus  
Dilator  
4,0 mm Ø



ZI-23-851-00  
Grünwald  
Atomizer complete  
with 3 atomizers  
3 flasks in rack,  
without rubber bulb

ZI-23-851-01  
Grünwald  
Atomizer  
straight tube

ZI-23-851-02  
Grünwald  
Atomizer  
tube down wards

ZI-23-851-03  
Grünwald  
Atomizer  
tube up wards



ZI-23-851-04  
Grünwald  
Spare Flask  
Spare Flask

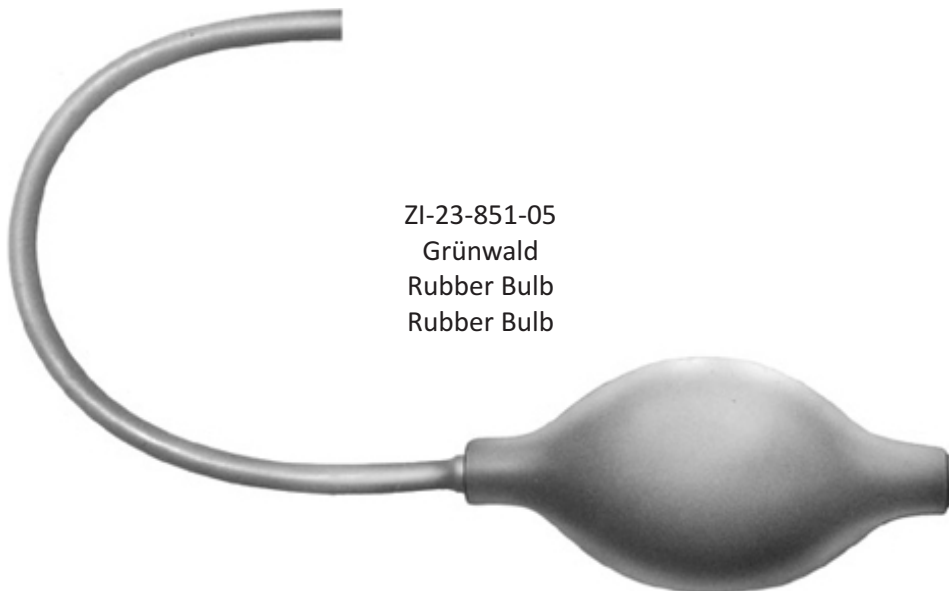

ZI-23-851-05  
Grünwald  
Rubber Bulb  
Rubber Bulb

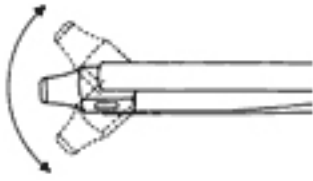

ZI-23-855-00

Universal

Atomizer with adjustable nozzle bottle and rubber bulb

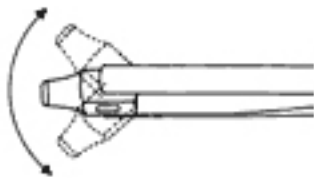

ZI-23-855-01

Universal

Atomizer as ref. ZI-37-855-00  
without rubber bulb



ZI-23-855-04

Spare Bottle

Spare Bottle





*Products that saves life*

# ZARYAB

---

## I N S T R U M E N T S

 Harar, Wazirabad Road, Pir Sabz Rd, Pir Sabz, Sialkot-51310, Pakistan

 +92 52 3573775

 +92 52 3573776

 +92 333 8608580 , +92 333 3349600

 [info@zaryabinstruments.com](mailto:info@zaryabinstruments.com)

 [sales@zaryabinstruments.com](mailto:sales@zaryabinstruments.com)

 [www.zaryabinstruments.com](http://www.zaryabinstruments.com)