



*Products that saves life*

# ZARYAB

---

## INSTRUMENTS



## CALIPERS, OTOLOGY

### Catalogue





## Calipers



ZI-21-133-06  
Castroviejo  
8cm 3 1/4 "  
Caliper measuring range  
15 mm



ZI-21-133-07  
Castroviejo  
8cm 4 1/4 "  
Caliper measuring range  
20 mm



ZI-21-133-09  
Castroviejo  
8cm 5 1/4 "  
Caliper measuring range  
20 mm



ZI-21-134-09  
Castroviejo-Epker  
9cm 3 1/2 "  
Caliper measuring range  
40 mm



ZI-21-134-18  
Castroviejo-Epker  
18cm 7"  
Caliper measuring range  
40 mm



ZI-21-135-18  
Castroviejo-Epker  
18cm 7"  
Caliper measuring range  
40 mm



## Otology

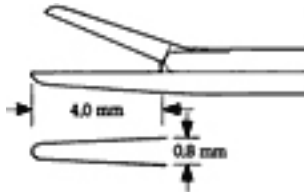

ZI-22-001-01  
Micro Ear Forceps  
4,0 x 0,8 mm  
smooth, straight  
shaft length 80 mm

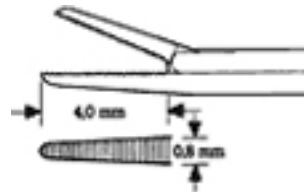

ZI-22-001-06  
Micro Ear Forceps  
4,0 x 0,8 mm  
serrated, straight  
shaft length 80 mm

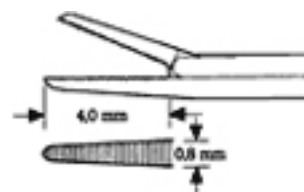

ZI-22-001-07  
Micro Ear Forceps  
4,0 x 0,8 mm  
bent upwards, serrated  
shaft length 80 mm

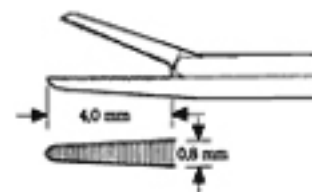

ZI-22-001-08  
Micro Ear Forceps  
4,0 x 0,8 mm  
right, serrated  
shaft length 80 mm

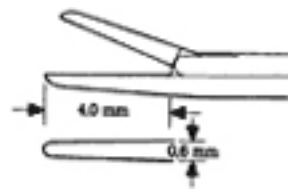

ZI-22-001-09  
Micro Ear Forceps  
4,0 x 0,8 mm  
left, serrated  
shaft length 80 mm

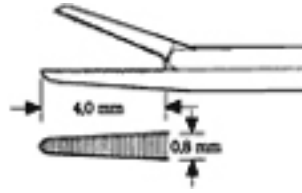

ZI-22-001-11  
Mini-McGee  
Micro Ear Forceps  
3,5 x 0,6 mm  
smooth, straight  
shaft length 80 mm

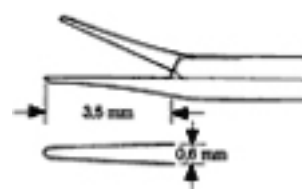

ZI-22-001-16  
Mini-McGee  
Micro Ear Forceps  
3,5 x 0,6 mm  
serrated, straight  
shaft length 80 mm

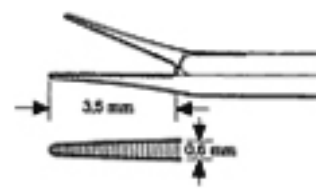

ZI-22-001-21  
Micro Ear Forceps  
4,0 x 0,6 mm  
smooth, straight  
shaft length 80 mm

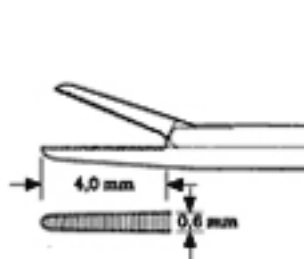

ZI-22-001-26  
Micro Ear Forceps  
4,0 x 0,6 mm  
serrated, straight  
shaft length 80 mm

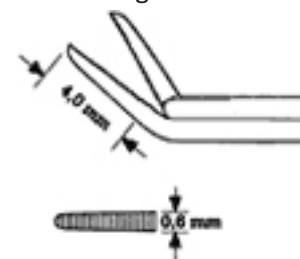

ZI-22-001-27  
Micro Ear Forceps  
3,0 x 0,6 mm  
bent upwards, serrated  
shaft length 80 mm

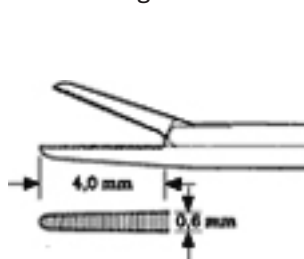

ZI-22-001-28  
Micro Ear Forceps  
3,0 x 0,6 mm  
right, serrated  
shaft length 80 mm

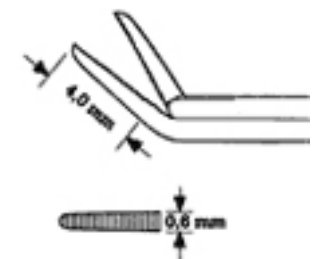

ZI-22-001-29  
Micro Ear Forceps  
3,0 x 0,6 mm  
left, serrated  
shaft length 80 mm



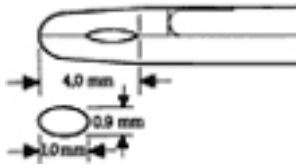

ZI-22-003-01  
Micro Ear Forceps  
4,0 mm cup 1,0 x 0,9 mm  
straight shaft length 80 mm

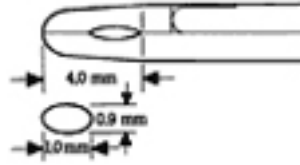

ZI-22-003-02  
Micro Ear Forceps  
4,0 mm cup 1,0 x 0,9 mm  
bent upwards  
shaft length 80 mm

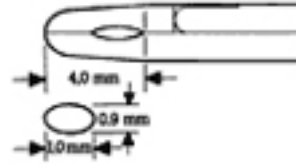

ZI-22-003-03  
Micro Ear Forceps  
4,0 mm  
cup 1,0 x 0,9 mm  
right shaft length 80 mm

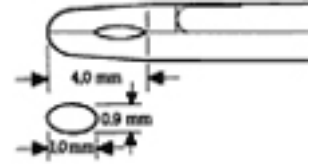

ZI-22-003-04  
Micro Ear Forceps  
4,0 mm  
cup 1,0 x 0,9 mm  
left shaft length 80 mm

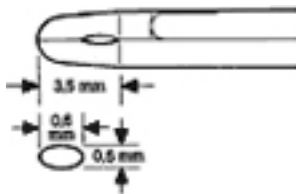

ZI-22-003-11  
Micro Ear Forceps  
3,5 mm  
cup 0,6 x 0,5 mm  
straight shaft length 80 mm

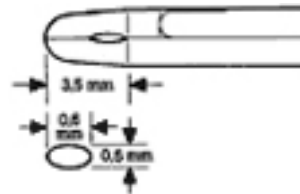

ZI-22-003-12  
Micro Ear Forceps  
3,5 mm  
cup 0,6 x 0,5 mm  
bent upwards  
shaft length 80 mm

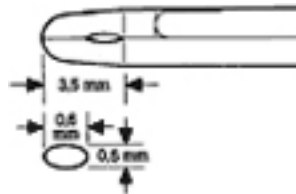

ZI-22-003-13  
Micro Ear Forceps  
3,5 mm  
cup 0,6 x 0,5 mm  
right shaft length 80 mm

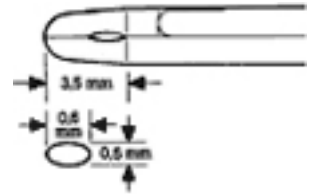

ZI-22-003-14  
Micro Ear Forceps  
3,5 mm  
cup 0,6 x 0,5 mm  
left shaft length 80 mm



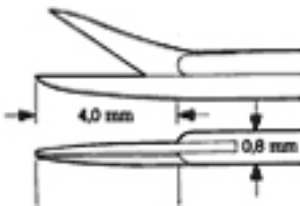

ZI-22-005-01  
Bellucci  
Micro Ear Scissor  
svery fine  
4,0 x 0,8 mm  
straight  
shaft length 80 mm

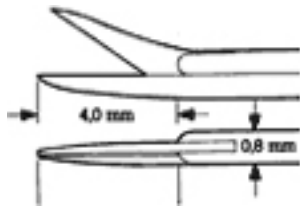

ZI-22-005-02  
Bellucci  
Micro Ear Scissor  
svery fine  
4,0 x 0,8 mm  
bent upwards  
shaft length 80 mm

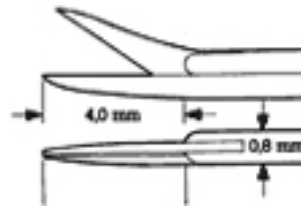

ZI-22-005-03  
Bellucci  
Micro Ear Scissor  
svery fine  
4,0 x 0,8 mm  
right shaft  
length 80 mm

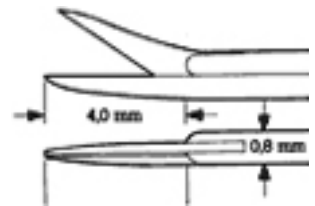

ZI-22-005-04  
Bellucci  
Micro Ear Scissor  
svery fine  
4,0 x 0,8 mm  
left shaft  
length 80 mm



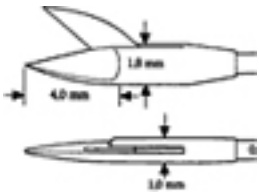

ZI-22-005-51  
Wullstein  
Micro Ear Scissors  
4,0 x 1,0 mm  
straight shaft 0,8 mm  $\varnothing$   
shaft length 80 mm

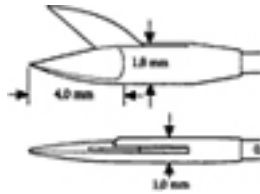

ZI-22-005-52  
Wullstein  
Micro Ear Scissors  
4,0 x 1,0 mm  
bent upwards  
shaft 0,8 mm  $\varnothing$   
shaft length 80 mm

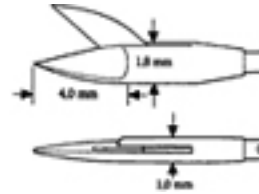

ZI-22-005-53  
Wullstein  
Micro Ear Scissors  
4,0 x 1,0 mm  
right shaft 0,8 mm  $\varnothing$   
shaft length 80 mm

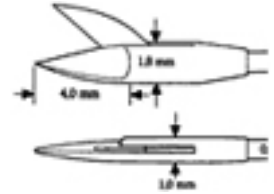

ZI-22-005-54  
Wullstein  
Micro Ear Scissors  
4,0 x 1,0 mm  
lefts haft 0,8 mm  $\varnothing$   
shaft length 80 mm



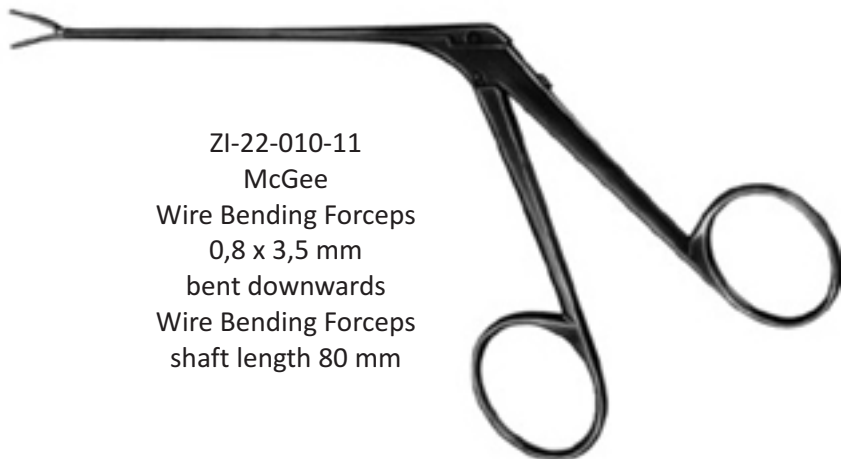

ZI-22-010-11  
McGee  
Wire Bending Forceps  
0,8 x 3,5 mm  
bent downwards  
Wire Bending Forceps  
shaft length 80 mm

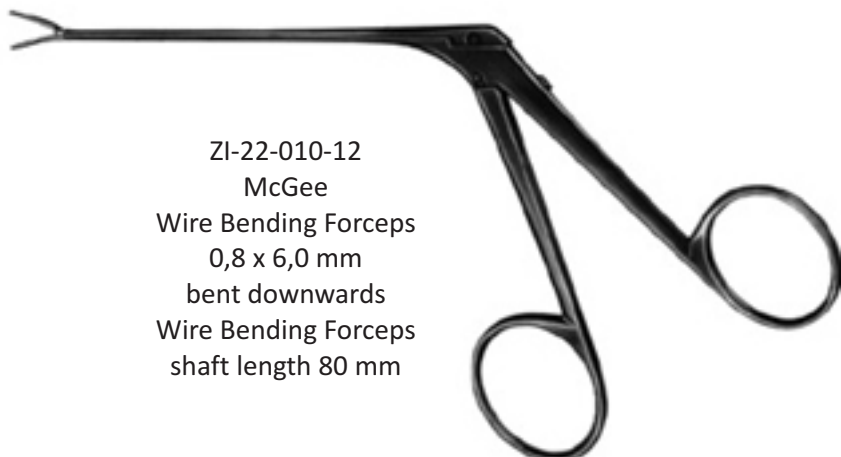

ZI-22-010-12  
McGee  
Wire Bending Forceps  
0,8 x 6,0 mm  
bent downwards  
Wire Bending Forceps  
shaft length 80 mm





ZI-22-011-01  
House-Dieter  
Malleus Nipper  
up-cutting  
Malleus Nipper  
shaft length 80 mm



ZI-22-011-02  
House-Dieter  
Malleus Nipper  
down-cutting  
Malleus Nipper  
shaft length 80 mm



ZI-22-011-06  
House-Dieter  
Malleus Nipper  
right-cutting  
Malleus Nipper  
shaft length 80 mm



ZI-22-011-07  
House-Dieter  
Malleus Nipper  
left-cutting  
Malleus Nipper  
shaft length 80 mm





**ZARYAB**  
INSTRUMENTS

*Products that saves life*

Otology

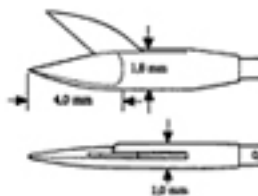

ZI-22-013-01  
Fuller  
Introducing Forceps  
for teflon prostheses  
Introducing  
Forceps  
shaft length 80 mm



ZI-22-020-02  
Schuknecht  
Rotary Knife  
Rotary Knife



ZI-22-020-06  
Schuknecht  
14.5cm 5 3/4"  
Sickle Knife  
Sickle Knife



ZI-22-020-11  
Wullstein  
15.5cm 6"  
Sickle Knife  
Sickle Knife



ZI-22-020-16  
Tabb  
Mucosa Knife  
Mucosa Knife



ZI-22-020-21  
Plester  
15cm 6"  
Flap Knife  
Flap Knife

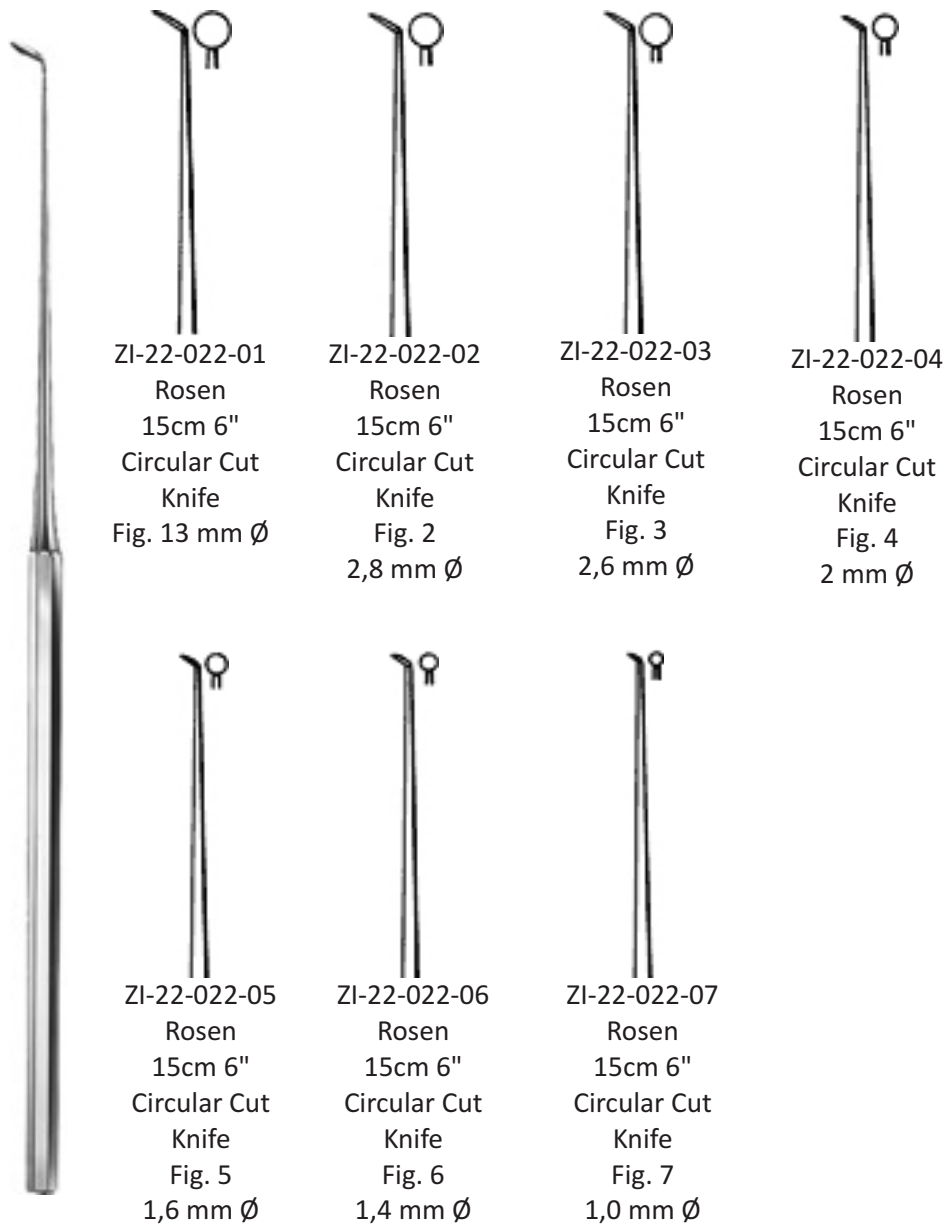



## Otology



ZI-22-024-01  
Barbara  
16cm 6 1/4"

Micro Ear Needle



ZI-22-024-02  
Barbara  
16cm 6 1/4"

Micro Ear Needle



ZI-22-024-03  
Barbara  
16cm 6 1/4"

Micro Ear Needle



ZI-22-024-04  
Rosen  
16cm 6 1/4"

Micro Ear Needle



ZI-22-024-06  
Barbara  
16cm 6 1/4"

Micro Ear Hook  
0,3 mm



ZI-22-024-07  
Barbara  
16cm 6 1/4"

Micro Ear Hook  
0,6 mm



ZI-22-024-08  
Barbara  
16cm 6 1/4"

Micro Ear Hook  
1,0 mm



ZI-22-024-11  
Barbara  
16cm 6 1/4"

Micro Ear Hook  
0,3 mm



ZI-22-024-12  
Barbara  
16cm 6 1/4"

Micro Ear Hook  
0,6 mm



ZI-22-024-13  
Barbara  
16cm 6 1/4"

Micro Ear Hook  
1,0 mm



ZI-22-024-14  
Barbara  
16cm 6 1/4"

Micro Ear Hook  
1,2 mm



ZI-22-024-15  
Barbara  
16cm 6 1/4"

Micro Ear Hook  
1,5 mm



ZI-22-024-16  
Barbara  
16cm 6 1/4"

Micro Ear Hook  
2,0 mm



ZI-22-024-17  
Barbara  
16cm 6 1/4"

Micro Ear Hook  
2,5 mm



ZI-22-024-21  
Fisch  
16cm 6 1/4"  
Micro Ear  
Hook  
0,3 mm



ZI-22-024-22  
Fisch  
16cm 6 1/4"  
Micro Ear  
Hook  
0,6 mm



ZI-22-024-23  
Fisch  
16cm 6 1/4"  
Micro Ear  
Hook  
1,0 mm



ZI-22-024-24  
Fisch  
16cm 6 1/4"  
Micro Ear  
Hook  
1,2 mm



ZI-22-024-25  
Fisch  
16cm 6 1/4"  
Micro Ear  
Hook  
1,5 mm



ZI-22-024-26  
Fisch  
16cm 6 1/4"  
Micro Ear  
Hook  
2,0 mm



ZI-22-024-27  
Fisch  
16cm 6 1/4"  
Micro Ear  
Hook  
2,5 mm



**ZARYAB**  
I N S T R U M E N T S

*Products that saves life*

Otology



ZI-22-024-31  
Barbara  
16cm 6 1/4"  
Micro Ear Hook  
0,5 mm

ZI-22-024-32  
Barbara  
16cm 6 1/4"  
Micro Ear Hook  
1,0 mm



ZI-22-025-01  
15.5cm 6"  
Micro Ear Hook  
0,3 mm



ZI-22-025-02  
15.5cm 6"  
Micro Ear Hook  
0,6 mm



ZI-22-025-03  
15.5cm 6"  
Micro Ear Hook  
1,0 mm



ZI-22-025-06  
15.5cm 6"  
Micro Ear Hook  
0,3 mm



ZI-22-025-07  
15.5cm 6"  
Micro Ear Hook  
0,6 mm



ZI-22-025-08  
15.5cm 6"  
Micro Ear Hook  
1,0 mm





**ZARYAB**  
I N S T R U M E N T S

*Products that saves life*

Otology



ZI-22-029-01  
Barbara  
15.5cm 6"  
Micro Ear Needle



ZI-22-029-06  
Barbara  
15.5cm 6"  
Micro Ear Needle



ZI-22-030-06  
Micro Ear Hook  
0,3 mm 25°



ZI-22-030-07  
Micro Ear Hook  
0,6 mm 25°



ZI-22-030-08  
Shambaugh  
Micro Ear Hook  
1,0 mm 25°



ZI-22-030-11  
Micro Ear Hook  
0,3 mm 45°



ZI-22-030-12  
Micro Ear Hook  
0,6 mm 45°



ZI-22-030-13  
Shambaugh  
Micro Ear Hook  
1,0 mm 45°



ZI-22-030-20  
Shea  
Exploring Hook  
2,0 mm 45°  
blunt Exploring Hook

ZI-22-030-30  
Austin  
Attic Dissector  
3,0 mm 90°  
blunt Attic Dissector



ZI-22-036-01  
Fisch  
15.5cm 6"  
Micro Dissector  
angled to right

ZI-22-036-02  
Fisch  
15.5cm 6"  
Micro Dissector  
angled to left

ZI-22-036-05  
Fisch  
15.5cm 6"  
Micro Dissector  
angled to right

ZI-22-036-06  
Fisch  
15.5cm 6"  
Micro Dissector  
angled to left



**ZARYAB**  
I N S T R U M E N T S

*Products that saves life*

Otology



ZI-22-036-23  
Rosen  
15.5cm 6"  
Micro Ear Periosteal Elevator



ZI-22-038-01  
House  
15.5cm 6"  
Micro  
Measuring Rod  
3,5 mm



ZI-22-038-02  
House  
15.5cm 6"  
Micro  
Measuring Rod  
4,0 mm



ZI-22-038-03  
House  
15.5cm 6"  
Micro  
Measuring Rod  
4,5 mm



ZI-22-038-04  
House  
15.5cm 6"  
Micro  
Measuring Rod  
5,0 mm



ZI-22-044-01  
House  
14.5cm 5 3/4"  
Micro Curette  
1,0 / 1,2 mm



ZI-22-044-02  
House  
14.5cm 5 3/4"  
Micro Curette  
1,5 / 1,8 mm



ZI-22-044-03  
House  
14.5cm 5 3/4"  
Micro Curette  
1,0 / 1,2 mm



ZI-22-044-04  
House  
14.5cm 5 3/4"  
Micro Curette  
1,5 / 1,8 mm



ZI-22-118-03  
Toynbee  
3.6cm 1 1/2"  
Ear Specula,  
Setfor adults  
Fig. 2 – 4  
Ear Specula, set



ZI-22-118-11  
Toynbee  
3.6cm 1 1/2"  
Ear Speculum  
Fig. 14,0 mm Ø



ZI-22-118-12  
Toynbee  
3.6cm 1 1/2"  
Ear Speculum  
Fig. 25,0 mm Ø



ZI-22-118-13  
Toynbee  
3.6cm 1 1/2"  
Ear Speculum  
Fig. 36,0 mm Ø



ZI-22-118-14  
Toynbee  
3.6cm 1 1/2"  
Ear Speculum  
Fig. 47,5 mm Ø



ZI-22-119-04  
Toynbee  
3.6cm 1 1/2"  
Ear Specula,  
Setfor adults  
Fig. 1 – 4  
Ear Specula, set



ZI-22-112-03  
Hartmann  
3.6cm 1 1/2"  
Ear Specula,  
Setfor children  
Fig. 0 – 2  
Ear Specula, set



ZI-22-112-10  
Hartmann  
3.6cm 1 1/2"  
Ear Speculum  
Fig. 03,0 mm Ø



ZI-22-112-11  
Hartmann  
3.6cm 1 1/2"  
Ear Speculum  
Fig. 14,0 mm Ø



ZI-22-112-12  
Hartmann  
3.6cm 1 1/2"  
Ear Speculum  
Fig. 25,0 mm Ø



ZI-22-112-13  
Hartmann  
3.6cm 1 1/2"  
Ear Speculum  
Fig. 36,0 mm Ø



ZI-22-112-14  
Hartmann  
3.6cm 1 1/2"  
Ear Speculum  
Fig. 47,5 mm Ø



ZI-22-114-03  
Hartmann  
3.61 1/2"  
Ear Specula,  
Setfor adults  
Fig. 2 – 4  
Ear Specula, set



ZI-22-115-04  
Hartmann  
3.6cm 1 1/2"  
Ear Specula,  
Setfor adults  
Fig. 1 – 4  
Ear Specula, set





ZI-22-132-00  
Zöllner  
3.8cm 1 1/2"  
Ear Specula,  
Setconsisting  
of 6 pieces  
Fig. 1 - 6  
Ear Specula,  
setoval, black



ZI-22-132-01  
Zöllner  
3.8cm 1 1/2"  
Ear Speculum  
Fig. 1  
5,5 x 6,5 mm  
oval, black



ZI-22-132-02  
Zöllner  
3.8cm 1 1/2"  
Ear Speculum  
Fig. 2  
6,5 x 7,5 mm  
oval, black



ZI-22-132-03  
Zöllner  
3.8cm 1 1/2"  
Ear Speculum  
Fig. 3  
7,5 x 8,5 mm  
oval, black



ZI-22-132-04  
Zöllner  
3.8cm 1 1/2"  
Ear Speculum  
Fig. 48,5 x 9,5 mm  
oval, black



ZI-22-132-05  
Zöllner  
3.8cm 1 1/2"  
Ear Speculum  
Fig. 59,5 x 10,5 mm  
oval, black



ZI-22-132-06  
Zöllner  
3.8cm 1 1/2"  
Ear Speculum  
Fig. 6  
10,5 x 11,5 mm  
oval, black



1

ZI-22-134-01  
Farrior  
3.6cm 1 1/2"  
Ear Speculum  
Fig. 15,5 mm  
black

2

ZI-22-134-02  
Farrior  
3.6cm 1 1/2"  
Ear Speculum  
Fig. 2  
6,5 mm black

3

ZI-22-134-03  
Farrior  
3.6cm 1 1/2"  
Ear Speculum  
Fig. 3  
7,5 mm black

4

ZI-22-134-04  
Farrior  
3.6cm 1 1/2"  
Ear Speculum  
Fig. 4  
8,5 mm black

5

ZI-22-134-05  
Farrior  
3.6cm 1 1/2"  
Ear Speculum  
Fig. 5  
9,5 mm black

6

ZI-22-134-06  
Farrior  
3.6cm 1 1/2"  
Ear Speculum  
Fig. 6  
10,5 mm black

7

ZI-22-134-07  
Farrior  
3.6cm 1 1/2"  
Ear Speculum  
Fig. 7  
11,5 mm black



**ZARYAB**  
INSTRUMENTS

*Products that saves life*

Otology

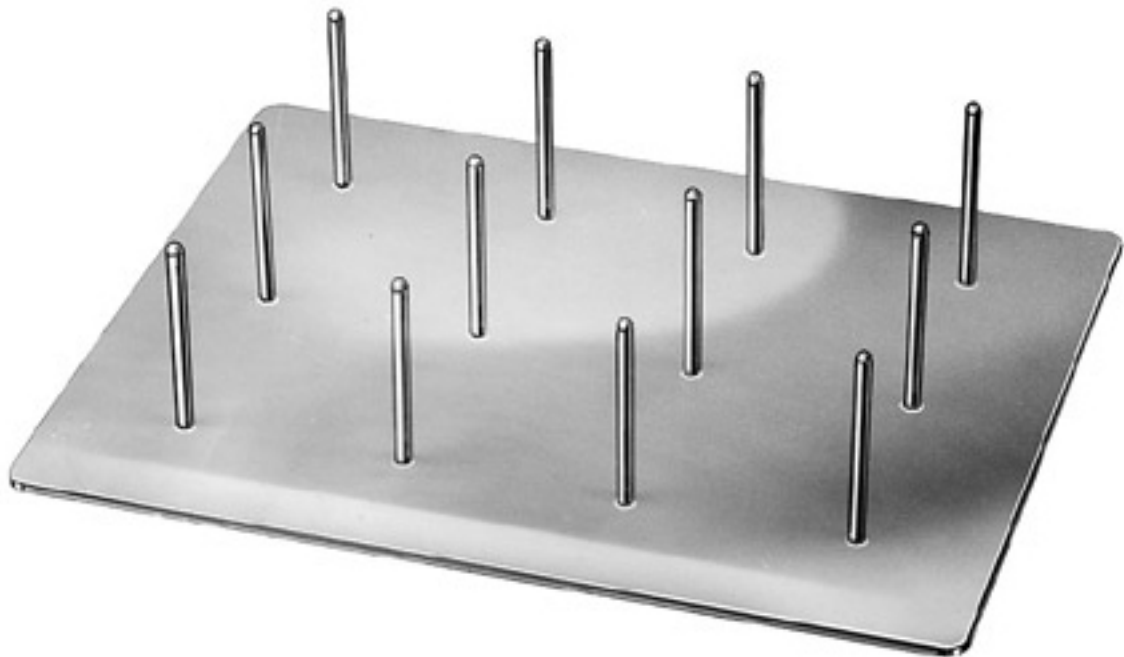

ZI-22-148-12  
Ear Specula Storage Rack



ZI-22-170-07  
French  
Tuning Fork  
C2 - 16



ZI-22-172-08  
French  
Tuning Fork  
C1 - 32



ZI-22-174-09  
Hartmann  
Tuning Fork  
C 64



ZI-22-175-10  
Hartmann  
Tuning Fork  
c 128



ZI-22-177-11  
Hartmann  
Tuning Fork  
c1 - 256



ZI-22-180-10  
Martin  
Tuning Fork  
c1 128



ZI-22-182-11  
Martin  
Tuning Fork  
c1 256



ZI-22-184-12  
Martin-Alloy  
Tuning Fork  
c2 512



ZI-22-186-13  
Martin-Alloy  
Tuning Fork  
c3 1024



ZI-22-188-14  
Martin-Alloy  
Tuning Fork  
c4 2048



**ZARYAB**  
INSTRUMENTS

*Products that saves life*

Otology



ZI-22-189-10  
Hartmann  
Tuning Fork  
c 128



ZI-22-192-11  
Hartmann  
Tuning Fork  
c1 256



ZI-22-194-12  
Hartmann  
Tuning Fork  
c2 512



**ZARYAB**  
INSTRUMENTS

*Products that saves life*

## Otology



ZI-22-196-13  
Hartmann  
Tuning Fork  
c3 1024



ZI-22-198-14  
Hartmann  
Tuning Fork  
c4 2048



ZI-22-200-15  
Hartmann  
Tuning Fork  
c5 4096



ZI-22-210-10  
Lucae  
Tuning Fork  
c 128



ZI-22-212-11  
Lucae  
Tuning Fork  
c 256



ZI-22-214-12  
Lucae  
Tuning Fork  
c 512



ZI-22-216-13  
Lucae  
Tuning Fork  
c 1024





ZI-22-218-14  
Lucae  
Tuning Fork  
c4 2048



ZI-22-220-15  
Lucae  
Tuning Fork  
c5 4096



ZI-22-221-10  
Lucae  
Tuning Fork  
c 128  
movable up to h



ZI-22-222-10  
Hartmann  
Tuning Fork  
c 128  
movable up to h



ZI-22-223-11  
Hartmann  
Tuning Fork  
c 256



ZI-22-224-10  
Rydel-Seiffert  
Tuning Fork  
C 64 / c 128  
with dampers =  
C 64  
without dampers =  
c 128  
also for Neurology



ZI-22-226-00  
Neuro  
Tuning Fork  
with hammer,  
pinwheel,  
brush and needle



ZI-22-230-59  
König  
Tuning Fork  
A 109  
movable up to g



ZI-22-234-61  
Tuning Fork  
a<sup>1</sup> 440



**ZARYAB**  
I N S T R U M E N T S

*Products that saves life*

## Otology



ZI-22-321-01  
Hartmann  
15cm 6"  
Ear Catheter  
Fig. 1



ZI-22-321-02  
Hartmann  
15cm 6"  
Ear Catheter  
Fig. 2



ZI-22-321-03  
Hartmann  
15cm 6"  
Ear Catheter  
Fig. 3





**ZARYAB**  
INSTRUMENTS

*Products that saves life*

Otology



ZI-22-351-16  
Krause  
18.5cm 7 1/4"  
Polypus Snare  
open tip



ZI-22-353-16  
Krause-Voss  
18.5cm 7 1/4"  
Polypus Snare  
closed tip





ZI-22-358-30  
Snare Wire  
0,3 mm  $\varnothing$   
coil of 10 m  
Snare Wire



ZI-22-358-40  
Snare Wire  
0,4 mm  $\varnothing$   
coil of 10 m  
Snare Wire



ZI-22-371-11  
Troeltsch (Wilde)  
10.5cm 4 1/8"  
Ear Forceps



ZI-22-375-12  
Troeltsch (Wilde)  
11cm 4 3/8"  
Ear Forceps



ZI-22-381-13  
Troeltsch (Wilde)  
12.5cm 5"  
Ear Forceps





# ZARYAB INSTRUMENTS

Products that saves life

## Otology



ZI-22-391-14  
Grünwald  
14.5cm 5 3/4"  
Ear Forceps



ZI-22-395-16  
Jansen  
16cm 6 1/4"  
Ear Forceps



ZI-22-395-20  
Jansen  
21.5cm 8 1/2"  
Ear Forceps



ZI-22-401-12  
Littauer  
10cm 4"  
Ear Polypus Forceps



ZI-22-405-12  
Hartmann  
12cm 4 3/4"  
Ear Polypus Forceps  
fine model

ZI-22-407-14  
Hartmann  
14cm 5 1/2"  
Ear Polypus Forceps  
regular model



ZI-22-416-11  
Buck  
11.5cm 4 1/2"  
Foreign Body Lever  
Foreign Body Forceps



ZI-22-418-10  
Quire  
10.5cm 4 1/8"  
Foreign Body Lever  
Foreign Body Lever





ZI-22-425-08  
Hartmann-Wullstein  
Ear Polypus Forceps  
shaft length 85 mm



ZI-22-427-08  
Hartmann-Wullstein  
Ear Polypus Forceps  
shaft length  
85 mm 1,0 mm Ø



ZI-22-430-08  
Hartmann  
Ear Polypus Forceps  
shaft length 85 mm



ZI-22-430-14  
Hartmann  
Ear Polypus Forceps  
shaft length  
140 mm



ZI-22-431-08  
Hartmann  
Ear Polypus Forceps  
shaft length  
85 mm 1:2 teeth



ZI-22-442-81  
Hartmann-Herzfeld  
Ear Polypus Forceps  
shaft length  
85 mm 2,0 mm Ø



ZI-22-442-82  
Hartmann-Herzfeld  
Ear Polypus Forceps  
shaft length  
85 mm 2,5 mm Ø



ZI-22-442-83  
Hartmann-Herzfeld  
Ear Polypus Forceps  
shaft length  
85 mm 3,0 mm Ø



ZI-22-448-08  
Strümpel  
Ear Polypus Forceps



ZI-22-456-08  
Hartmann-Hoffman  
Ear Polypus Forceps  
2,0 mm Ø  
through-cutting





ZI-22-461-17  
Citelli  
Mastoid Rongeur  
3 mm cut

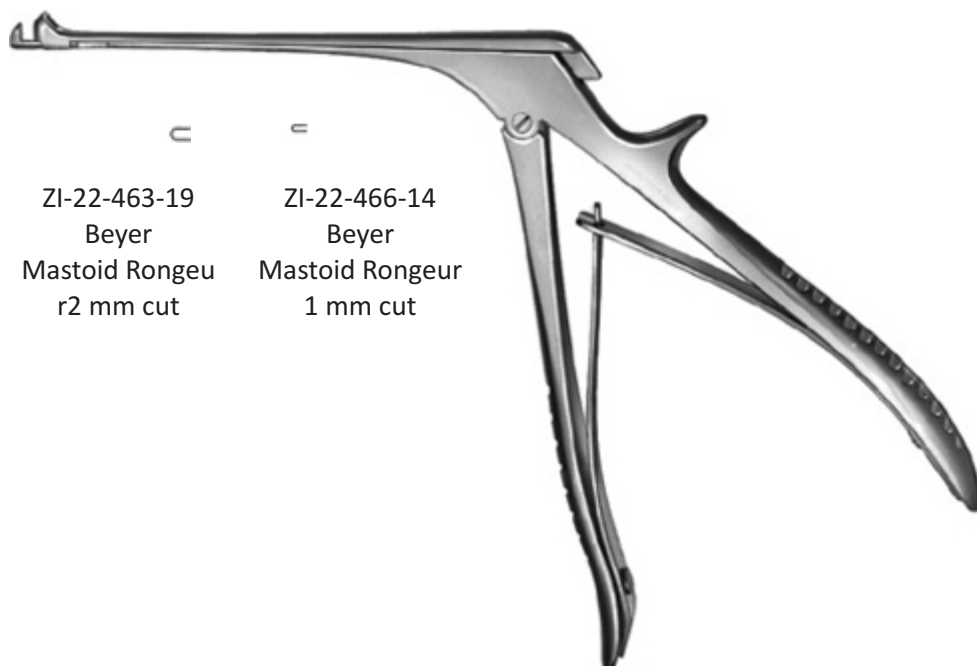

ZI-22-463-19  
Beyer  
Mastoid Rongeur  
2 mm cut

ZI-22-466-14  
Beyer  
Mastoid Rongeur  
1 mm cut



**ZARYAB**  
INSTRUMENTS

*Products that saves life*

## Otology



ZI-22-491-13  
Langen beck  
13cm 5"  
Ear Curetteblunt



ZI-22-493-01  
Shapleigh  
15cm 6"  
Ear Curette



ZI-22-493-02  
Shapleigh  
15cm 6"  
Ear Curette



ZI-22-495-02  
Buck  
17x6 3/4"  
Ear Curette  
Fig. 00  
blunt



ZI-22-495-10  
Buck  
17cm 6 3/4"  
Ear Curette  
Fig. 0  
blunt



ZI-22-495-11  
Buck  
17cm 6 3/4"  
Ear Curette  
Fig. 1  
blunt



ZI-22-495-12  
Buck  
17cm 6 3/4"  
Ear Curette  
Fig. 2blunt



ZI-22-497-01  
Buck  
17cm 6 3/4"  
Ear Curette  
Fig. 000blunt



ZI-22-497-02  
Buck  
17cm 6 3/4"  
Ear Curette  
Fig. 00blunt



ZI-22-497-10  
Buck  
17cm 6 3/4"  
Ear Curette  
Fig. 0blunt



ZI-22-497-11  
Buck  
17cm 6 3/4"  
Ear Curette  
Fig. 1blunt



ZI-22-497-12  
Buck  
17cm 6 3/4"  
Ear Curette  
Fig. 2blunt



ZI-22-497-13  
Buck  
17cm 6 3/4"  
Ear Curette  
Fig. 3blunt



ZI-22-497-14  
Buck  
17cm 6 3/4"  
Ear Curette  
Fig. 4blunt



ZI-22-498-01  
Buck  
17cm 6 3/4"  
Ear Curette  
Fig. 000sharp



ZI-22-498-02  
Buck  
17cm 6 3/4"  
Ear Curette  
Fig. 00sharp



ZI-22-498-10  
Buck  
17cm 6 3/4"  
Ear Curette  
Fig. 0sharp



ZI-22-498-11  
Buc  
k17cm 6 3/4"  
Ear Curette  
Fig. 1sharp



ZI-22-498-12  
Buck  
17cm 6 3/4"  
Ear Curette  
Fig. 2sharp



ZI-22-498-13  
Buck  
17cm 6 3/4"  
Ear Curette  
Fig. 3sharp



ZI-22-498-14  
Buck  
17cm 6 3/4"  
Ear Curette  
Fig. 4sharp



ZI-22-532-15  
Jansen  
17cm 6 3/4"  
Ear Scoopsharp



ZI-22-543-12  
Gross  
13cm 5"  
Ear Scoop/Hookblunt  
Ear Scoop/Hook



ZI-22-551-01  
Weber-Loch  
16.5cm 6 1/2"  
Foreign Body  
Instrument  
Ear Loop



ZI-22-554-01  
Billeau  
16cm 6 1/4"  
Ear Loop  
Ear Loop



ZI-22-554-02  
Billeau  
16cm 6 1/4"  
Ear Loop  
Ear Loop



ZI-22-554-03  
Billeau  
16cm 6 1/4"  
Ear Loop  
Ear Loop





ZI-22-561-16  
Moldenhauer  
15.5cm 6"  
Foreign Body Lever  
Foreign Body Lever



ZI-22-563-16  
Zaufal  
15cm 6"  
Foreign Body Lever  
Foreign Body Lever



ZI-22-570-16  
Hartmann  
16cm 6 1/4"  
Ear Hooklet  
sharp Ear Hooklet





ZI-22-577-01  
Lucae  
14cm 5 1/2"  
Ear Hooklet small



ZI-22-577-02  
Lucae  
14cm 5 1/2"  
Ear Hooklet medium



ZI-22-577-03  
Lucae  
14cm 5 1/2"  
Ear Hooklet large



ZI-22-585-01  
Wagener  
14cm 5 1/2"  
Ear Hook let  
Fig. 1



ZI-22-585-02  
Wagener  
14cm 5 1/2"  
Ear Hook let  
Fig. 2



ZI-22-585-03  
Wagener  
14cm 5 1/2"  
Ear Hook let  
Fig. 3



ZI-22-585-04  
Wagener  
14cm 5 1/2"  
Ear Hook let  
Fig. 4



ZI-22-585-05  
Wagener  
14cm 5 1/2"  
Ear Hook let  
Fig. 5



ZI-22-585-06  
Wagener  
14cm 5 1/2"  
Ear Hook let  
Fig. 6 sharp



ZI-22-585-07  
Wagener  
14cm 5 1/2"  
Ear Hook let  
Fig. 7

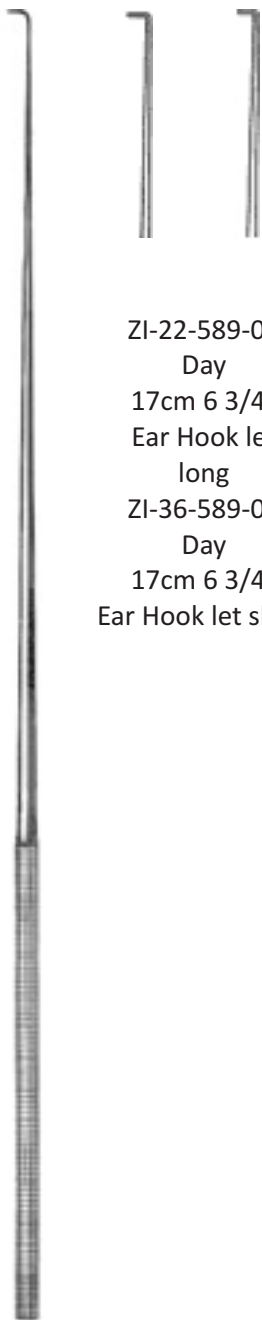

ZI-22-589-01  
Day  
17cm 6 3/4"  
Ear Hook let  
long  
ZI-36-589-02  
Day  
17cm 6 3/4"  
Ear Hook let short



ZI-22-613-16      ZI-22-630-16  
Politzer              Politzer  
14.5cm 5 3/4"      17.5cm 7"T  
Furuncle Knife    tympanum Lancet  
Furuncle Knife

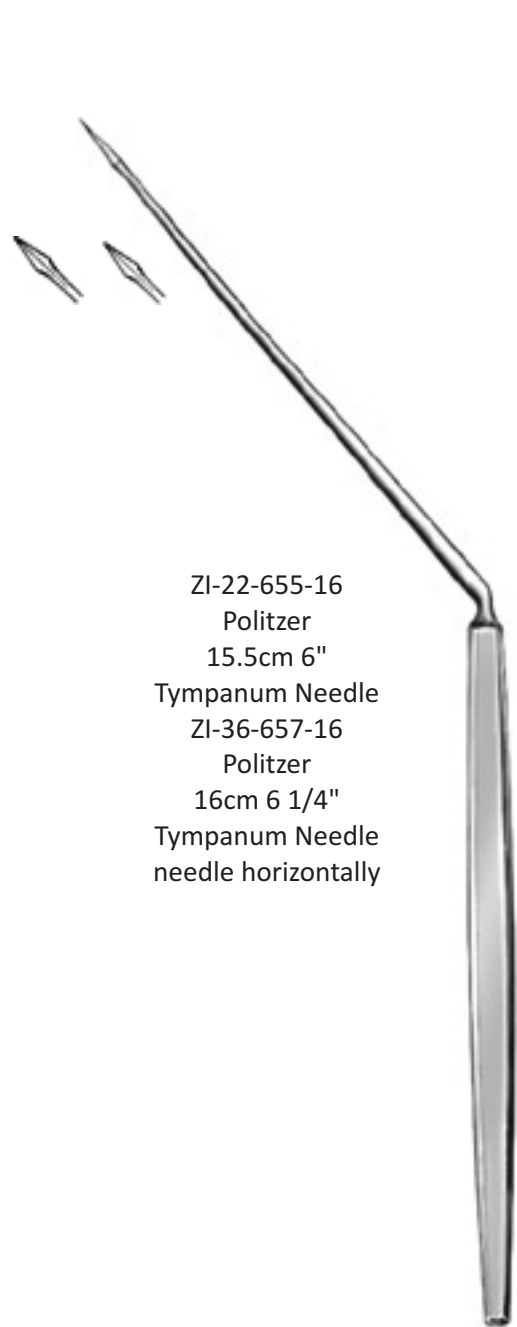

ZI-22-655-16  
Politzer  
15.5cm 6"  
Tympanum Needle  
ZI-36-657-16  
Politzer  
16cm 6 1/4"  
Tympanum Needle  
needle horizontally



ZI-22-661-18  
Lucae  
17.5cm 7"  
Tympanum Needle



ZI-22-663-18  
Lucae  
17.5cm 7"  
Tympanum Needle

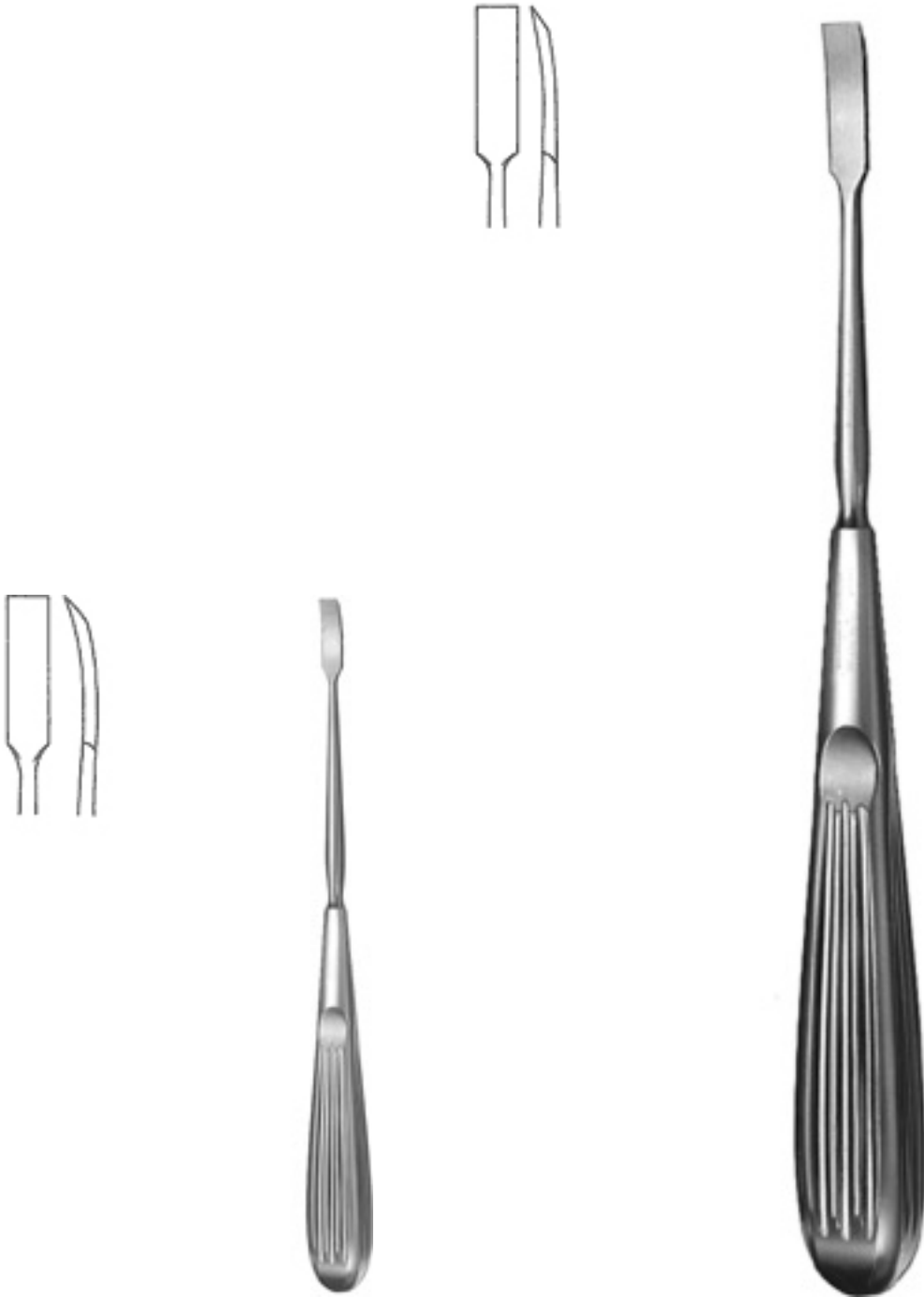

ZI-22-737-20  
Lempert  
20.5cm 8"  
Micro Ear Periosteal Elevator  
6 mm

ZI-22-739-17  
Lempert  
18cm 7"  
Micro Ear Periosteal Elevator  
6 mm



o

ZI-22-743-10  
Lempert  
21.5cm 8 1/2"  
Ear Scoop  
sharp

o

ZI-22-743-20  
Lempert  
21.5cm 8 1/2"  
Ear Scoop  
sharp

o

ZI-22-743-30  
Lempert  
21.5cm 8 1/2"  
Ear Scoop  
sharp

o

ZI-22-743-40  
Lempert  
21.5cm 8 1/2"  
Ear Scoop  
sharp

o

ZI-22-743-50  
Lempert  
21.5cm 8 1/2"  
Ear Scoop  
sharp



## Otology



ZI-22-780-00  
Kabierske  
Atomizer  
complete with  
cannulas and  
rubber bulb



ZI-22-780-01  
Kabierske  
Spare Bottle  
30 c  
Spare Bottle



ZI-22-780-08  
Kabierske  
8cm 3 1/8"  
Ear Cannula  
Ear Cannula



ZI-22-780-11  
Kabierske  
11cm 4 3/8"  
Ear Cannula  
Ear Cannula



ZI-22-780-13  
Kabierske  
13cm 5 1/8"  
Ear Cannula  
Ear Cannula



ZI-22-780-50  
Kabierske  
Valve Rubber Bulb  
Valve Rubber Bulb



**ZARYAB**  
INSTRUMENTS

*Products that saves life*

Otology



ZI-22-785-00  
Kabierske  
Atomizer  
complete with 3 cannulas  
and rubber bul  
band metal base

ZI-22-785-85  
Kabierske  
Metal base, only~  
Metal base, only





ZI-22-786-00  
Universal  
Atomizer complete  
with movable tube,  
screw bottle 30 c  
and rubber bulb

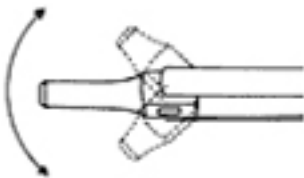

ZI-22-786-01  
Universal  
Atomizer ref.  
ZI-36-786-00  
but without rubber bulb



ZI-22-792-00  
Poltizer  
Air Bag complete with  
3 nasal olives  
ref. ZI-36-792-15 to ZI-36-792-22  
ZI-36-792-01 Poltizer  
Air Bagas  
ref. 36-792-00 with  
additional ear olive  
ref. 36-792-04



ZI-22-792-02  
Poltizer  
Air Bagas ref.  
ZI-36-792-01  
in plastic box



ZI-22-792-03  
Politzer  
Connecting Nozzle  
Connecting Nozzle



ZI-22-792-04  
Politzer  
Ear Olive  
4 mm Ø  
Ear Olive



ZI-22-792-15  
Politzer  
Nose Olive  
15 mm Ø  
Nose Olive



ZI-22-792-17  
Politzer  
Nose Olive  
17 mm Ø  
Nose Olive



ZI-22-792-22  
Politzer  
Nose Olive  
22 mm Ø  
Nose Olive



ZI-36-792-50  
Politzer  
Rubber Bulb



**ZARYAB**  
INSTRUMENTS

*Products that saves life*

Otology

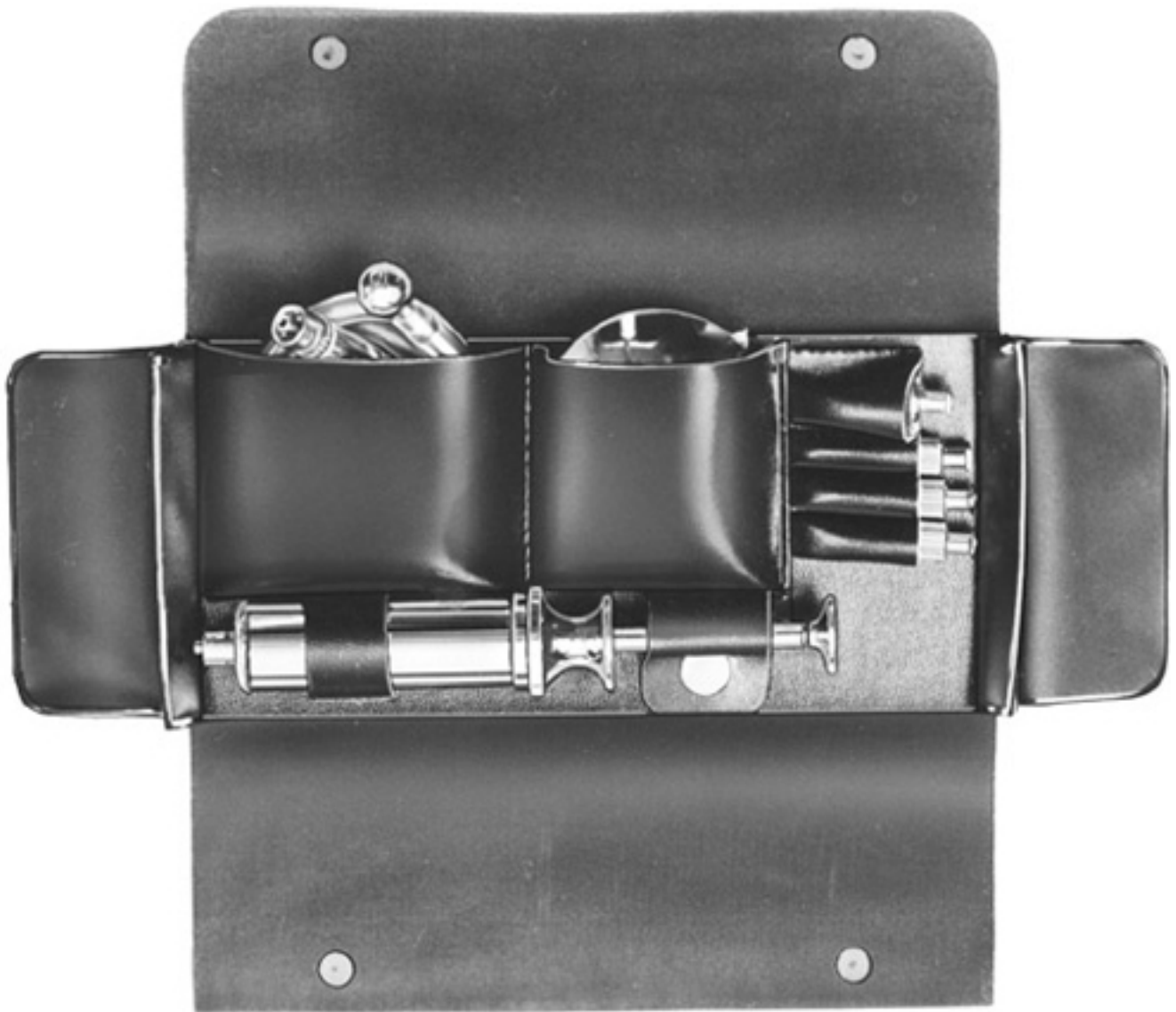

ZI-22-794-00  
Ear Syringe  
self fillin  
gin plastic pouch



ZI-22-794-02  
Valve Attachment  
Valve Attachment



ZI-22-794-03  
Flexible Tube  
Flexible Tube



ZI-22-794-04  
Suction Nozzle  
Suction Nozzle



ZI-22-794-05  
Protecting Disc  
Protecting Disc



ZI-22-794-06  
Metal Olive  
Metal Olive



ZI-22-794-07  
Conical Tip  
Conical Tip



ZI-22-794-08  
Button ended Tip  
Button ended Tip



ZI-22-794-09  
Threaded Tip  
Threaded Tip



**ZARYAB**  
INSTRUMENTS

*Products that saves life*

Otology



ZI-22-795-00  
Ear Syringe  
complete with  
protection disc  
and 2 tips 50 ml

ZI-22-795-04  
Ear Syringe  
complete with  
protection disc  
and 2 tips 100 ml

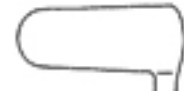

ZI-22-817-01  
Goldsmith  
(Thudichum)  
6.5cm 2 1/2"  
Nasal Speculum  
Fig. 1  
blades  
21,0 x 9,5 mm

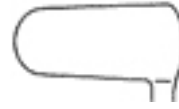

ZI-22-817-02  
Goldsmith  
(Thudichum)  
6.5cm 2 1/2"  
Nasal Speculum  
Fig. 2  
blades  
21,0 x 10,5 mm



ZI-22-817-03  
Goldsmith  
(Thudichum)  
6.5cm 2 1/2"  
Nasal Speculum  
Fig. 3  
blades  
21,0 x 11,5 mm



ZI-22-845-01  
Hartmann-Halle  
15.5cm 6"  
Nasal Speculum  
Fig. 1  
length of blade  
27 mm



ZI-22-845-02  
Hartmann-Halle  
15.5cm 6"  
Nasal Speculum  
Fig. 2  
length of blade  
31 mm



ZI-22-845-03  
Hartmann-Halle  
15.5cm 6"  
Nasal Speculum  
Fig. 3  
length of blade  
35 mm





ZI-22-848-13  
Martin  
13cm 5"  
Nasal Speculum  
length of blade 17 mm



ZI-22-849-13  
Martin  
12.5cm 5"  
Nasal Speculum  
length of blade 17 mm



ZI-22-852-13  
Tieck-Halle  
13cm 5"  
Nasal Speculum  
length of blade 16 mm





ZI-22-856-01  
Killian  
13cm 5"  
Nasal Speculum  
Fig. 1  
length of blade  
35 mm



ZI-22-856-02  
Killian  
13cm 5"  
Nasal Speculum  
Fig. 2  
length of blade  
50 mm

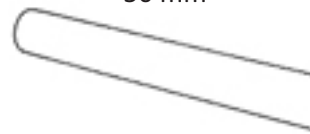

ZI-22-856-03  
Killian  
13cm 5"  
Nasal Speculum  
Fig. 3  
length of blade  
75 mm

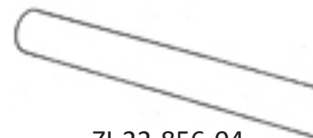

ZI-22-856-04  
Killian  
13cm 5"  
Nasal Speculum  
Fig. 4  
length of blade  
85 mm



**ZARYAB**  
I N S T R U M E N T S

*Products that saves life*

Otology



ZI-22-858-14  
Modell Wien  
13.5cm 5 1/4"  
Nasal Speculum  
length of blade 30 mm



ZI-22-859-35  
Cottle  
13.5cm 5 1/4"  
Nasal Speculum  
Fig. 1  
length of blade  
35 mm



ZI-22-859-50  
Cottle  
13.5cm 5 1/4"  
Nasal Speculum  
Fig. 2  
length of blade  
50 mm

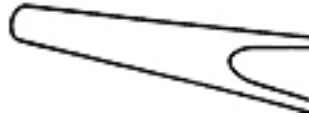

ZI-22-859-75  
Cottle  
13.5cm 5 1/4"  
Nasal Speculum  
Fig. 3  
length of blade  
75 mm

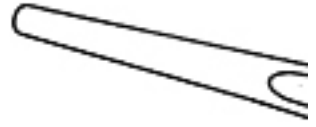

ZI-22-859-90  
Cottle  
14.5cm 5 3/4"  
Nasal Speculum  
Fig. 4  
length of blade  
85 mm





ZI-22-861-45  
Cottle  
13.5cm 5 1/4"  
length of blade  
45 mm



ZI-22-861-75  
Cottle  
14cm 5 1/2"  
length of blade  
75 mm



ZI-22-885-26  
Krause  
26cm 10 1/4"  
Polypus Snare  
shaft 3 mm Ø



ZI-22-887-26  
Krause-Voss  
26cm 10 1/4"  
Polypus Snare  
shaft 3 mm Ø



ZI-22-899-12  
10.5cm 4 1/8"  
Snare Wire  
0,3 mm Ø  
bundle with  
12 pieces  
Snare Wire





*Products that saves life*

# ZARYAB

---

## I N S T R U M E N T S

 Harar, Wazirabad Road, Pir Sabz Rd, Pir Sabz, Sialkot-51310, Pakistan

 +92 52 3573775

 +92 52 3573776

 +92 333 8608580 , +92 333 3349600

 [info@zaryabinstruments.com](mailto:info@zaryabinstruments.com)

 [sales@zaryabinstruments.com](mailto:sales@zaryabinstruments.com)

 [www.zaryabinstruments.com](http://www.zaryabinstruments.com)