



Products that saves life

ZARYAB

INSTRUMENTS



GYNECOLOGY

Catalogue



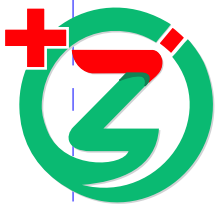

ZI-32-110-01
Cusco

Vaginal Speculum
75 x 32 mm

ZI-32-110-02
Cusco

Vaginal Speculum
85 x 35 mm

ZI-32-110-03
Cusco

Vaginal Speculum
100 x 35 mm



ZI-32-112-01
Cusco

Vaginal Speculum
75 x 18 mm



ZI-32-114-0
Cusco

Vaginal Speculum
80 x 22 mm

ZI-32-114-02
Cusco

Vaginal Speculum
100 x 25 mm

ZI-32-114-03
Cusco

Vaginal Speculum
105 x 27 mm



ZI-32-116-01
Cusco

Vaginal Speculum
75 x 34 mm

ZI-32-116-02
Cusco

Vaginal Speculum
85 x 37 mm

ZI-32-116-03
Cusco

Vaginal Speculum
100 x 37 mm

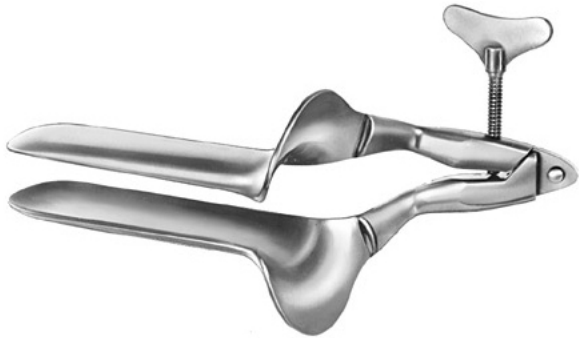

ZI-32-120-01
Collin Vaginal Speculum
85 x 30 mm
ZI-32-120-02
Collin Vaginal Speculum
100 x 35 mm
ZI-32-120-03
Collin Vaginal Speculum
110 x 40 mm

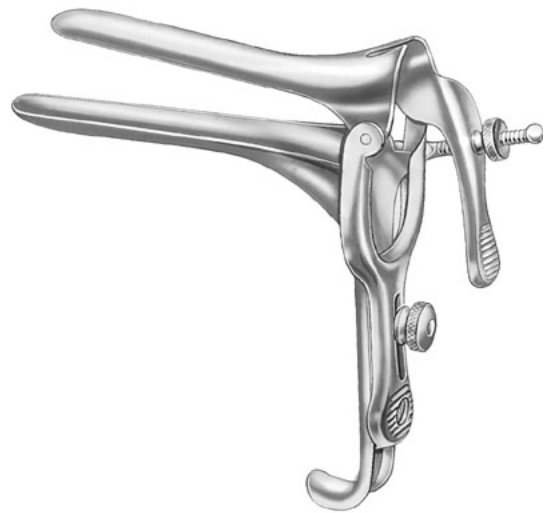

ZI-32-128-01
Pederson Vaginal Speculum
75 x 13 mm
ZI-32-128-02
Pederson Vaginal Speculum
100 x 22 mm
ZI-32-128-03
Pederson Vaginal Speculum
120 x 25 mm



ZI-32-130-01
Grave Vaginal Speculum
75 x 20 mm
ZI-32-130-02
Grave Vaginal Speculum
95 x 35 mm
ZI-32-130-03
Grave Vaginal Speculum
115 x 35 mm



ZI-32-132-01
Semm Vaginal Speculum
100 x 20 – 25 mm
ZI-32-132-02
Semm Vaginal Speculum
105 x 27 - 35 mm



Gynecology



ZI-32-160-01

Sims Vaginal Speculum
65 x 25 mm / 70 x 30 mm

ZI-32-160-02

Sims Vaginal Speculum
70 x 30 mm / 70 x 35 mm

ZI-32-160-03

Sims Vaginal Speculum
85 x 35 mm / 90 x 40 mm



ZI-32-182-01

Kristeller Vaginal Speculum
Fig. 1 70 x 27 mm

ZI-32-182-02

Kristeller Vaginal Speculum
Fig. 280 x 30 mm

ZI-32-182-03

Kristeller Vaginal Speculum
Fig. 390 x 36 mm



ZI-32-183-01

Kristeller Vaginal Retractor
Fig. 1 75 x 23 mm

ZI-32-183-02

Kristeller Vaginal Retractor
Fig. 285 x 26 mm

ZI-32-183-03

Kristeller Vaginal Retractor
Fig. 3100 x 32 mm



ZI-32-185-01

Kristeller Vaginal Speculumset no.
1 consisting of 32-182-01 + 32-183-01

ZI-32-185-02

Kristeller Vaginal Speculumset no.
2 consisting of 32-182-02 + 32-183-02

ZI-32-185-03

Kristeller Vaginal Speculumset no.
3 consisting of 32-182-03 + 32-183-03



ZI-32-190-01

Kristeller

Vaginal Speculum

Fig. 1105 x 18 mm

slender pattern

ZI-32-190-02

Kristeller

Vaginal Speculum

Fig. 2105 x 21 mm

slender pattern

ZI-32-191-01

Kristeller

Vaginal Retractor

Fig. 1110 x 14 mm

slender pattern

ZI-32-191-0

2Kristeller

Vaginal Retractor

Fig. 2110 x 17 mm

slender pattern

ZI-32-195-01

Kristeller

Vaginal Speculum

set no. 1consisting of

ZI-32-190-01 + ZI-32-191-01

slender pattern

ZI-32-195-02

Kristeller

Vaginal Speculum

set no. 2consisting of

ZI-32-190-02 + ZI-32-191-02

slender pattern

ZI-32-196-01

Kristeller

Vaginal Speculum

Fig. 1 105 x 26 mm

flat speculum

ZI-32-196-02

Kristeller

Vaginal Speculum

Fig. 2105 x 28 mm

flat speculum

ZI-32-196-03

Kristeller

Vaginal Speculum

Fig. 3105 x 33 mm

flat speculum

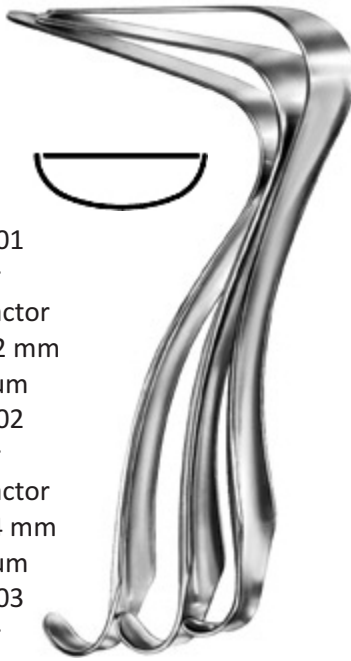

ZI-32-197-01
Kristeller
Vaginal Retractor
Fig. 1 115 x 22 mm
flat speculum
ZI-32-197-02
Kristeller
Vaginal Retractor
Fig. 2 115 x 24 mm
flat speculum
ZI-32-197-03
Kristeller
Vaginal Retractor
Fig. 3 115 x 29 mm
flat speculum

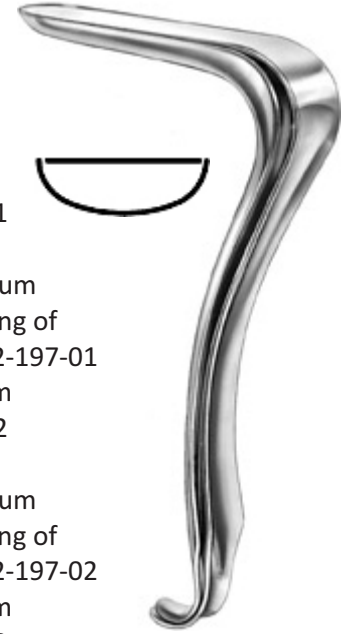

ZI-32-199-01
Kristeller
Vaginal Speculum
set no. 1 consisting of
ZI-32-196-01 + ZI-32-197-01
flat speculum
ZI-32-199-02
Kristeller
Vaginal Speculum
set no. 2 consisting of
ZI-32-196-02 + ZI-32-197-02
flat speculum
ZI-32-199-03
Kristeller
Vaginal Speculum
set no. 3 consisting of
ZI-32-196-03 + ZI-32-197-03
flat speculum

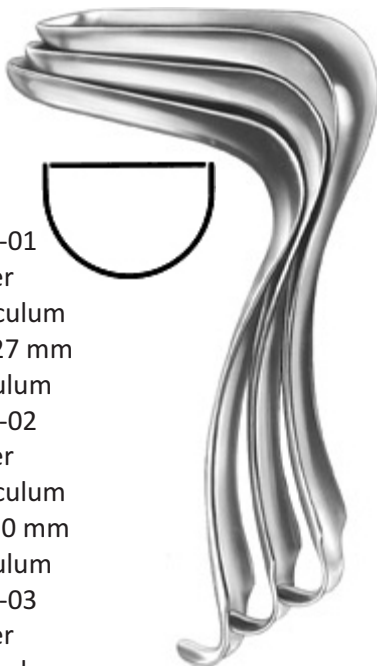

ZI-32-202-01
Kristeller
Vaginal Speculum
Fig. 1 110 x 27 mm
deep speculum
ZI-32-202-02
Kristeller
Vaginal Speculum
Fig. 2 110 x 30 mm
deep speculum
ZI-32-202-03
Kristeller
Vaginal Speculum
Fig. 3 110 x 36 mm
deep speculum

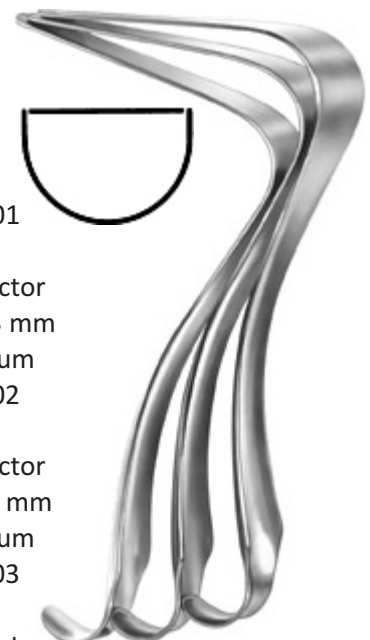

ZI-32-203-01
Kristeller
Vaginal Retractor
Fig. 1 115 x 23 mm
deep speculum
ZI-32-203-02
Kristeller
Vaginal Retractor
Fig. 2 115 x 26 mm
deep speculum
ZI-32-203-03
Kristeller
Vaginal Retractor
Fig. 3 115 x 32 mm
deep speculum

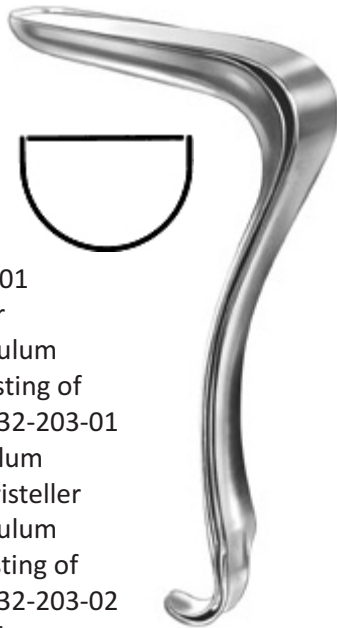

ZI-32-205-01
Kristeller
Vaginal Speculum
set no. 1 consisting of
ZI-32-202-01 + ZI-32-203-01
deep speculum
ZI-32-205-02 Kristeller
Vaginal Speculum
set no. 2 consisting of
ZI-32-202-02 + ZI-32-203-02
deep speculum
ZI-32-205-03
Kristeller
Vaginal Speculum
set no. 3 consisting of
ZI-32-202-03 + ZI-32-203-03
deep speculum

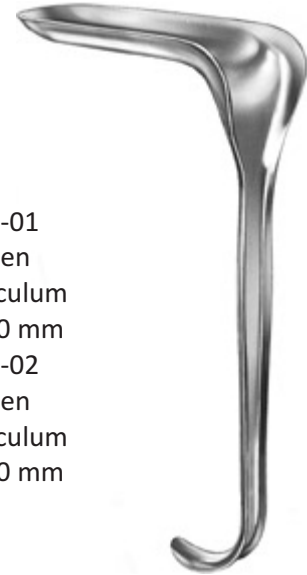

ZI-32-232-01
Kallmorgen
Vaginal Speculum
Fig. 170 x 40 mm
ZI-32-232-02
Kallmorgen
Vaginal Speculum
Fig. 290 x 40 mm

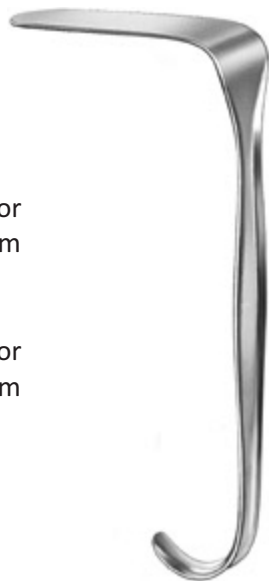

ZI-32-233-01
Kallmorgen
Vaginal Retractor
Fig. 170 x 33 mm
ZI-32-233-02
Kallmorgen
Vaginal Retractor
Fig. 290 x 33 mm

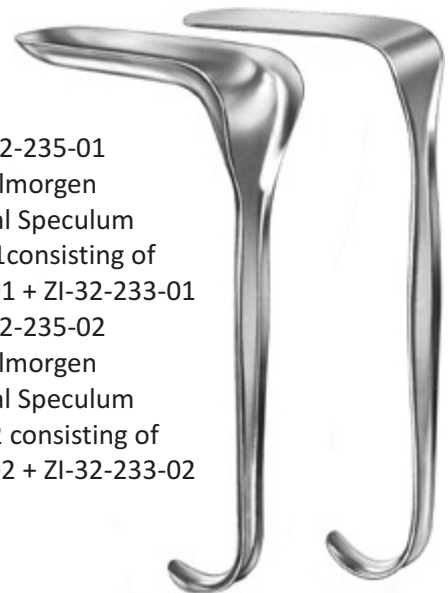

ZI-32-235-01
Kallmorgen
Vaginal Speculum
set no. 1 consisting of
ZI-32-232-01 + ZI-32-233-01
ZI-32-235-02
Kallmorgen
Vaginal Speculum
set no. 2 consisting of
ZI-32-232-02 + ZI-32-233-02

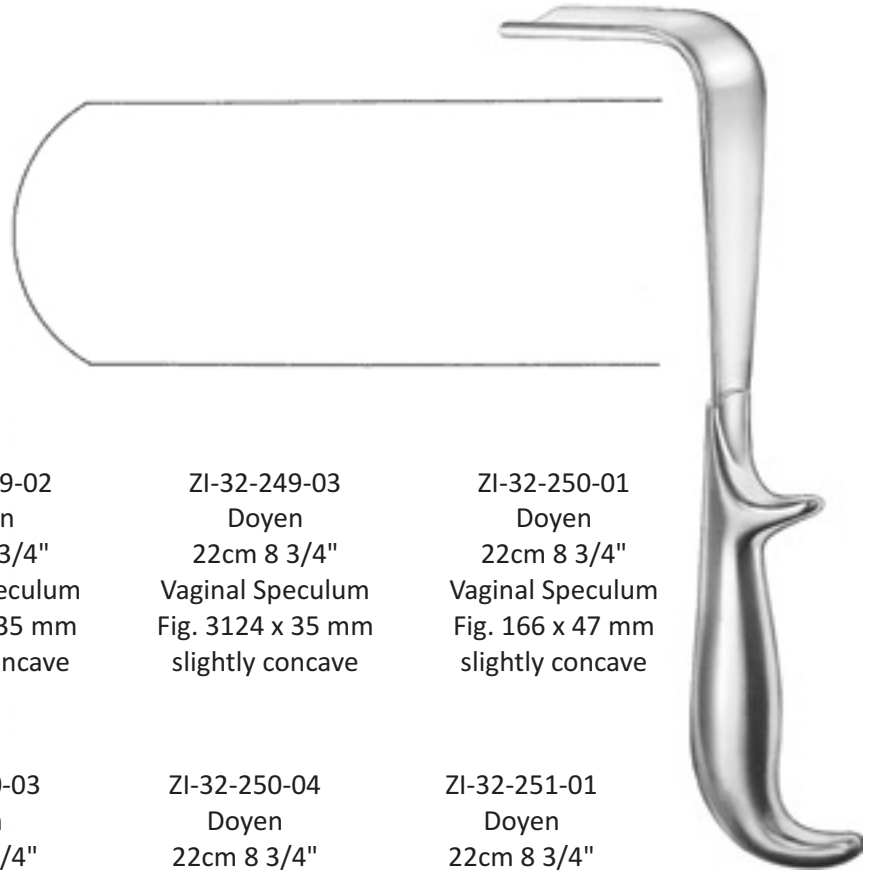

ZI-32-249-01
Doyen
22cm 8 3/4"
Vaginal Speculum
Fig. 163 x 35 mm
slightly concave

ZI-32-249-02
Doyen
22cm 8 3/4"
Vaginal Speculum
Fig. 294 x 35 mm
slightly concave

ZI-32-249-03
Doyen
22cm 8 3/4"
Vaginal Speculum
Fig. 3124 x 35 mm
slightly concave

ZI-32-250-01
Doyen
22cm 8 3/4"
Vaginal Speculum
Fig. 166 x 47 mm
slightly concave

ZI-32-250-02
Doyen
22cm 8 3/4"
Vaginal Speculum
Fig. 295 x 47 mm
slightly concave

ZI-32-250-03
Doyen
22cm 8 3/4"
Vaginal Speculum
Fig. 3126 x 47 mm
slightly concave

ZI-32-250-04
Doyen
22cm 8 3/4"
Vaginal Speculum
Fig. 4 160 x 47 mm
slightly concave

ZI-32-251-01
Doyen
22cm 8 3/4"
Vaginal Speculum
Fig. 155 x 60 mm
slightly concave

ZI-32-251-02
Doyen
22cm 8 3/4"
Vaginal Speculum
Fig. 295 x 60 mm
slightly concave

ZI-32-251-03
Doyen
22cm 8 3/4"
Vaginal Speculum
Fig. 3130 x 60 mm
slightly concave

ZI-32-251-04
Doyen
22cm 8 3/4"
Vaginal Speculum
Fig. 4 175 x 60 mm
slightly concave



ZI-32-302-00
Scherbak
Vaginal Speculum
complete set with handle,
weight (400 g) and 5 blades



ZI-32-302-01
Scherbak
Specula Blade,
only 80 x 30 mm
Specula Blade, only



ZI-32-302-02
Scherbak
Specula Blade,
only 85 x 35 mm
Specula Blade, only



ZI-32-302-03
Scherbak
Specula Blade,
only 90 x 40 mm
Specula Blade, only



Gynecology



ZI-32-302-04
Scherbak
Specula Blade,
only 62 x 40 - 60 mm
Specula Blade, only



ZI-32-302-05
Scherbak
Specula Blade,
only 81 x 45 - 70 mm
Specula Blade, only



ZI-32-302-10
Scherbak
10.5
Weight for Vaginal Speculum
400 g Weight for Vaginal Speculum

ZI-32-302-12
Scherbak
13cm 5"
Weight for Vaginal Speculum
800 g Weight for Vaginal Speculum



ZI-32-302-14
Scherbak
20cm 8"
Handle for Vaginal Speculum
Handle for Vaginal Speculum



ZARYAB
I N S T R U M E N T S

Products that saves life

Gynecology

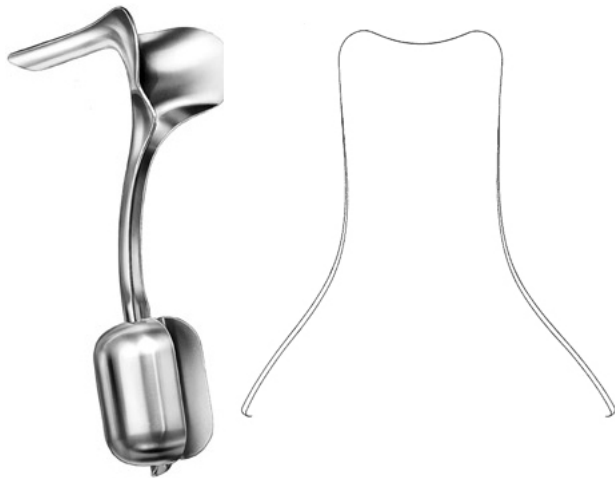

ZI-32-310-22
Auvard
23.5cm 9 1/4"
Vaginal Speculum
80 x 43 mm
complete,
with detachable weight



ZI-32-314-24
Weissbarth
21cm 8 1/4"
Vaginal Speculum
80 x 42 mm
complete,
with detachable strainer
ZI-32-314-99
Weissbarth
Strainer for Vaginal Speculum
Strainer for Vaginal Speculum



| | | | |
|--|--|--|--|
| ZI-32-323-20 Breisky 29cm 11 1/2" Vaginal Speculum 100 x 20 mm | ZI-32-323-25 Breisky 29cm 11 1/2" Vaginal Speculum 100 x 25 mm | ZI-32-323-30 Breisky 29cm 11 1/2" Vaginal Speculum 100 x 30 mm | ZI-32-323-35 Breisky 29cm 11 1/2" Vaginal Speculum 100 x 35 mm |
| ZI-32-323-40 Breisky 29cm 11 1/2" Vaginal Speculum 100 x 40 mm | ZI-32-324-20 Breisky 32cm 12 1/2" Vaginal Speculum 130 x 20 mm | ZI-32-324-25 Breisky 32cm 12 1/2" Vaginal Speculum 130 x 25 mm | ZI-32-324-30 Breisky 32cm 12 1/2" Vaginal Speculum 130 x 30 mm |
| ZI-32-324-35 Breisky 32cm 12 1/2" Vaginal Speculum 130 x 35 mm | ZI-32-324-40 Breisky 32cm 12 1/2" Vaginal Speculum 130 x 40 mm | ZI-32-325-40 Breisky 34.5cm 13 1/2" Vaginal Speculum 155 x 40 mm | |

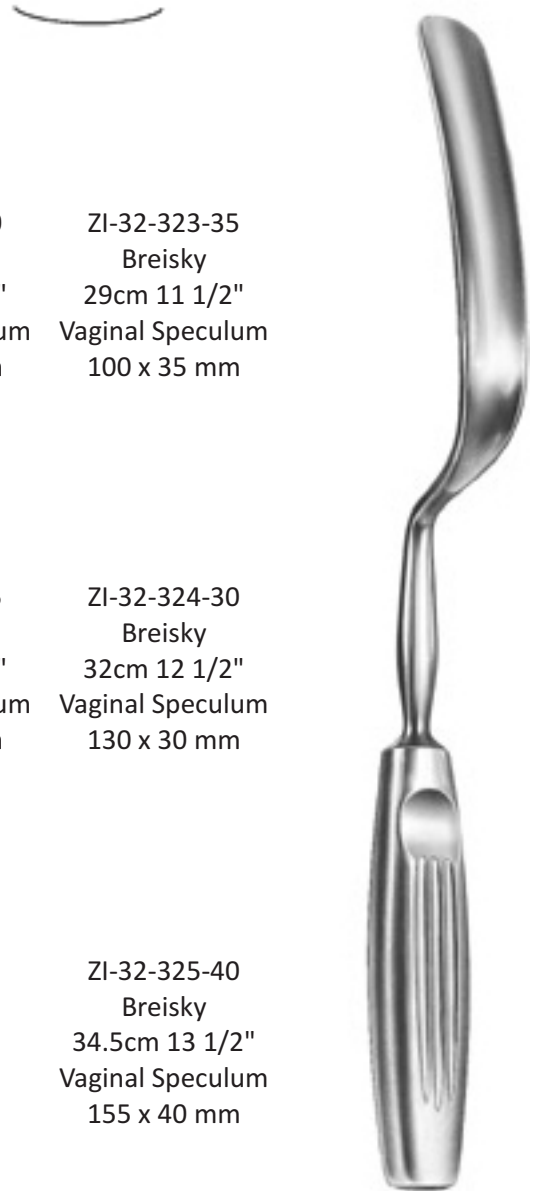



ZI-32-342-24
Doyen
25cm 9 3/4"
Vaginal Retractor
70 x 30 mm



ZI-32-381-24
Kogan
24.5cm 9 3/4"
Endocervical Speculum



ZI-32-383-24
Kogan
24.5cm 9 3/4"
Endocervical Speculum
with graduated ratchet
and fixing screw



- ZI-32-400-01 Hegar 18.5cm 7 1/4" Uterine Dilator 1,0
- ZI-32-400-02 Hegar 18.5cm 7 1/4" Uterine Dilator 2,0
- ZI-32-400-03 Hegar 18.5cm 7 1/4" Uterine Dilator 3,0
- ZI-32-400-04 Hegar 18.5cm 7 1/4" Uterine Dilator 4,0
- ZI-32-400-05 Hegar 18.5cm 7 1/4" Uterine Dilator 5,0
- ZI-32-400-06 Hegar 18.5cm 7 1/4" Uterine Dilator 6,0
- ZI-32-400-07 Hegar 18.5cm 7 1/4" Uterine Dilator 7,0
- ZI-32-400-08 Hegar 18.5cm 7 1/4" Uterine Dilator 8,0
- ZI-32-400-09 Hegar 18.5cm 7 1/4" Uterine Dilator 9,0
- ZI-32-400-10 Hegar 18.5cm 7 1/4" Uterine Dilator 10,0
- ZI-32-400-11 Hegar 18.5cm 7 1/4" Uterine Dilator 11,0
- ZI-32-400-12 Hegar 18.5cm 7 1/4" Uterine Dilator 12,0
- ZI-32-400-13 Hegar 18.5cm 7 1/4" Uterine Dilator 13,0
- ZI-32-400-14 Hegar 18.5cm 7 1/4" Uterine Dilator 14,0
- ZI-32-400-15 Hegar 18.5cm 7 1/4" Uterine Dilator 15,0
- ZI-32-400-16 Hegar 18.5cm 7 1/4" Uterine Dilator 16,0
- ZI-32-400-17 Hegar 18.5cm 7 1/4" Uterine Dilator 17,0
- ZI-32-400-18 Hegar 18.5cm 7 1/4" Uterine Dilator 18,0
- ZI-32-400-19 Hegar 18.5cm 7 1/4" Uterine Dilator 19,0
- ZI-32-400-20 Hegar 18.5cm 7 1/4" Uterine Dilator 20,0
- ZI-32-400-21 Hegar 18.5cm 7 1/4" Uterine Dilator 21,0
- ZI-32-400-22 Hegar 18.5cm 7 1/4" Uterine Dilator 22,0
- ZI-32-400-23 Hegar 18.5cm 7 1/4" Uterine Dilator 23,0
- ZI-32-400-24 Hegar 18.5cm 7 1/4" Uterine Dilator 24,0
- ZI-32-400-25 Hegar 18.5cm 7 1/4" Uterine Dilator 25,0
- ZI-32-400-26 Hegar 18.5cm 7 1/4" Uterine Dilator 26,0



ZARYAB
I N S T R U M E N T S

Products that saves life

Gynecology



ZI-32-400-80

Hegar

Uterine Dilators, Set
set of 14 pieces (full sizes)
from 4,0 to 17,0 mm without case

ZI-32-400-84

Hegar

Uterine Dilators, Set
set of 14 pieces (full sizes)
from 4,0 to 17,0 mm in metal case

ZI-32-400-90

Hegar

Uterine Dilators, Set
set of 26 pieces (full sizes)
from 1,0 to 26,0 mm without case



- ZI-32-401-01 Hegar 18.5cm 7 1/4" Uterine Dilator 1,5
- ZI-32-401-02 Hegar 18.5cm 7 1/4" Uterine Dilator 2,5
- ZI-32-401-03 Hegar 18.5cm 7 1/4" Uterine Dilator 3,5
- ZI-32-401-04 Hegar 18.5cm 7 1/4" Uterine Dilator 4,5
- ZI-32-401-05 Hegar 18.5cm 7 1/4" Uterine Dilator 5,5
- ZI-32-401-06 Hegar 18.5cm 7 1/4" Uterine Dilator 6,5
- ZI-32-401-07 Hegar 18.5cm 7 1/4" Uterine Dilator 7,5
- ZI-32-401-08 Hegar 18.5cm 7 1/4" Uterine Dilator 8,5
- ZI-32-401-09 Hegar 18.5cm 7 1/4" Uterine Dilator 9,5
- ZI-32-401-10 Hegar 18.5cm 7 1/4" Uterine Dilator 10,5
- ZI-32-401-11 Hegar 18.5cm 7 1/4" Uterine Dilator 11,5
- ZI-32-401-12 Hegar 18.5cm 7 1/4" Uterine Dilator 12,5
- ZI-32-401-13 Hegar 18.5cm 7 1/4" Uterine Dilator 13,5
- ZI-32-401-14 Hegar 18.5cm 7 1/4" Uterine Dilator 14,5
- ZI-32-401-15 Hegar 18.5cm 7 1/4" Uterine Dilator 15,5
- ZI-32-401-16 Hegar 18.5cm 7 1/4" Uterine Dilator 16,5
- ZI-32-401-17 Hegar 18.5cm 7 1/4" Uterine Dilator 17,5



- ZI-32-430-02 Hegar20cm 8" Uterine Dilator 1,0 / 2,0
- ZI-32-430-04 Hegar20cm 8" Uterine Dilator 3,0 / 4,0
- ZI-32-430-06 Hegar20cm 8" Uterine Dilator 5,0 / 6,0
- ZI-32-430-08 Hegar20cm 8" Uterine Dilator 7,0 / 8,0
- ZI-32-430-10 Hegar20cm 8" Uterine Dilator 9,0 / 10,0
- ZI-32-430-12 Hegar20cm 8" Uterine Dilator 11,0 / 12,0
- ZI-32-430-14 Hegar20cm 8" Uterine Dilator 13,0 / 14,0
- ZI-32-430-16 Hegar20cm 8" Uterine Dilator 15,0 / 16,0
- ZI-32-430-18 Hegar20cm 8" Uterine Dilator 17,0 / 18,0
- ZI-32-430-20 Hegar20cm 8" Uterine Dilator 19,0 / 20,0
- ZI-32-430-22 Hegar20cm 8" Uterine Dilator 21,0 / 22,0
- ZI-32-430-24 Hegar20cm 8" Uterine Dilator 23,0 / 24,0
- ZI-32-430-26 Hegar20cm 8" Uterine Dilator 25,0 / 26,0

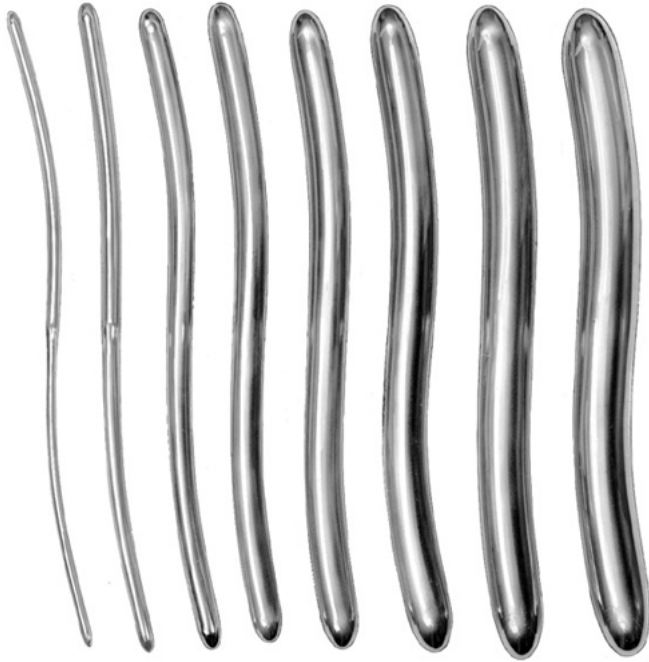

ZI-32-430-80
Hegar
Uterine Dilators,
Setset of 8 pieces from
3,0 / 4,0 to 17,0 / 18,0 mm
without case



ZI-32-430-82
Hegar
Uterine Dilators,
Setset of 8 pieces from
3,0 / 4,0 to 17,0 / 18,0 mm
in boilable canvas roll

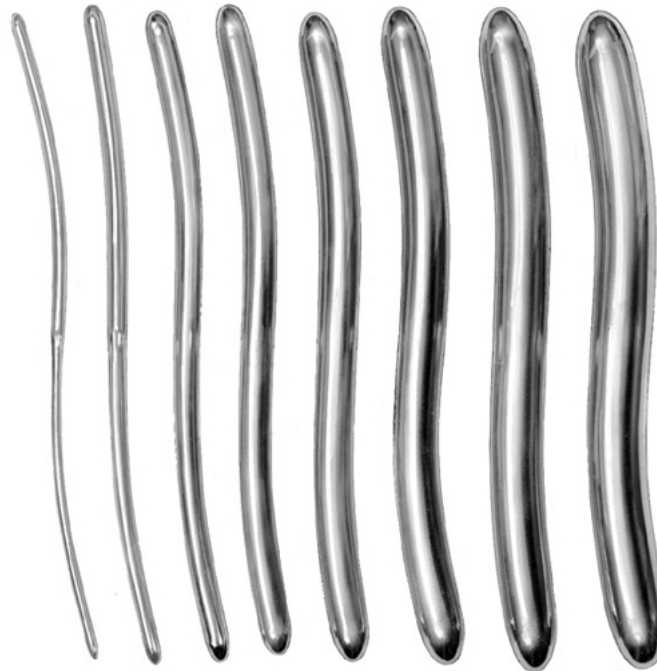

ZI-32-430-84
Hegar Uterine Dilators,
Setset of 8 pieces from 3,0 / 4,0 to 17,0 / 18,0 mm in metal case with hinged lid



ZI-32-460-10
Hank
26.5cm 10 1/2"
Uterine Dilator
Fig. 9/104,
5 / 5,0 mm Ø
American scale

ZI-32-460-12
Hank
26.5cm 10 1/2"
Uterine Dilator
Fig. 11/125,
5 / 6,0 mm Ø
American scale

ZI-32-460-14
Hank
26.5cm 10 1/2"
Uterine Dilator
Fig. 13/146,
5 / 7,0 mm Ø
American scale

ZI-32-460-16
Hank
26.5cm 10 1/2"
Uterine Dilator
Fig. 15/167,
5 / 8,0 mm Ø
American scale

ZI-32-460-18
Hank
26.5cm 10 1/2"
Uterine Dilator
Fig. 17/188,
5 / 9,0 mm Ø
American scale

ZI-32-460-20
Hank
26.5cm 10 1/2"
Uterine Dilator
Fig. 19/209,
5 / 10,0 mm Ø
American scale



ZARYAB
I N S T R U M E N T S

Products that saves life

Gynecology



ZI-32-460-82
Hank
Uterine Dilators,
Setset of 6 piezasin boilable
canvas roll



ZI-32-583-32
Sims
33cm 13"
Uterine Sound rigid



ZI-32-584-32
Sims
33cm 13"
Uterine Sound
malleable



ZI-32-593-25
Valleix
29.5cm 11 1/2"
Uterine Sound



ZI-32-595-26
Braun
27.5cm 10 3/4"
Uterine Depressor



ZI-32-622-25
Schröder
25.5cm 10"
Uterine Tenaculum Forceps



ZI-32-628-25
Braun
26cm 10 1/4"
Uterine Tenaculum Forceps



ZI-32-645-28
Duplay
25.5cm 10"
Uterine Tenaculum Forceps



ZI-32-659-26
Beacham
26cm 10 1/4"
Amniotome
Amniotome



ZI-32-663-24
Skene
24cm 9 1/2"
Uterine Tenaculum Forceps



ZI-32-682-24
Schröder
25cm 9 3/4"

Uterine Tenaculum Forceps



ZI-32-683-24
Schröder
23.5cm 9 1/4"

Uterine Tenaculum Forceps



ZI-32-697-23
Teale
23.5cm 9 1/4"
Uterine Tenaculum Forceps
3:4 teeth

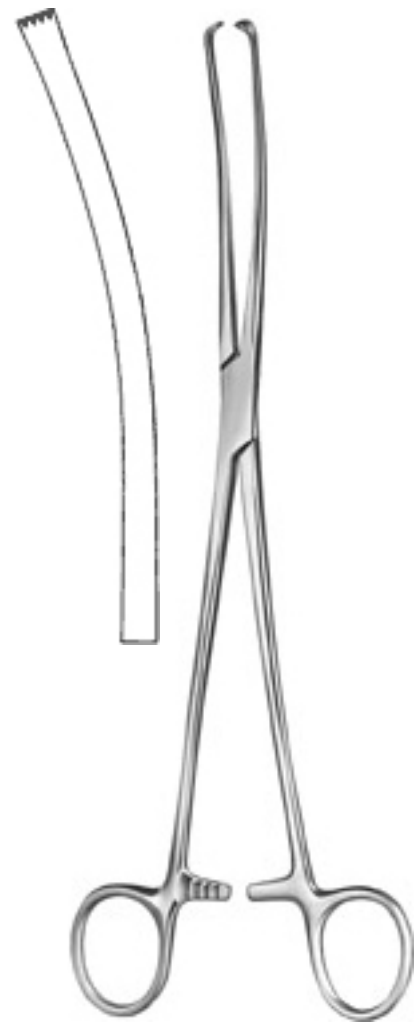

ZI-32-699-26
Iowa
26cm 10 1/4"
Uterine Tenaculum Forceps



ZARYAB
I N S T R U M E N T S

Products that saves life

Gynecology



ZI-32-702-24
Museux
24cm 9 1/2"
Uterine Tenaculum
Forceps
2:2 teeth6 mm



ZI-32-704-24
Museux
24cm 9 1/2"
Uterine Tenaculum
Forceps
2:2 teeth8 mm



ZI-32-706-24
Museux
24cm 9 1/2"
Uterine Tenaculum
Forceps
2:2 teeth10 mm



ZI-32-728-21
Jacobs
21cm 8 1/4"
Uterine Tenaculum
Forceps
2:2 teeth

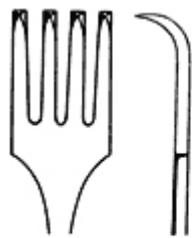

ZI-32-734-26
26.5cm 10 1/2"
Uterine Tenaculum
Forceps



ZI-32-738-16
Braun
16cm 6 1/4"
Uterine Tenaculum
Forceps



ZI-32-740-21
Czerny
21cm 8 1/4"
Uterine Tenaculum
Forceps

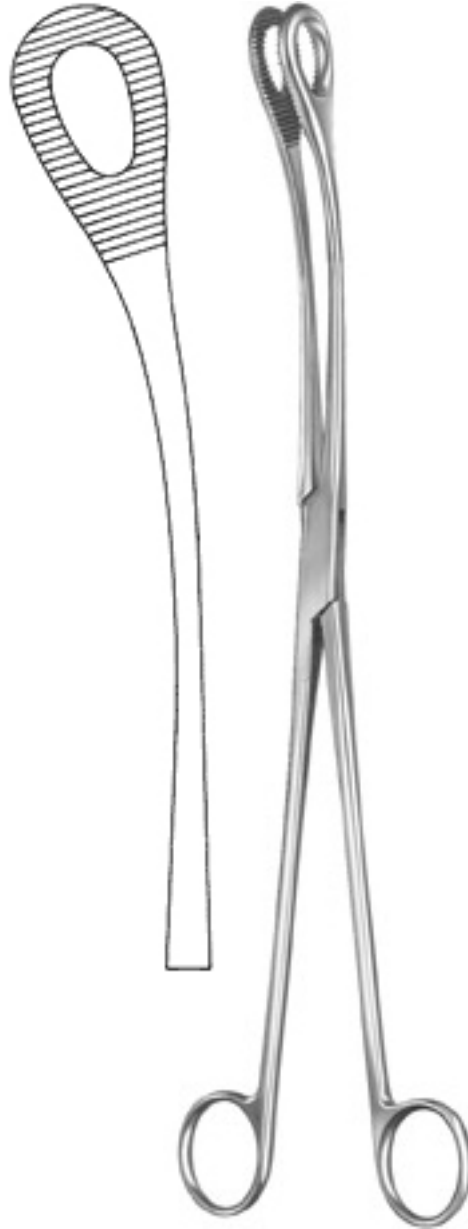

ZI-32-741-32
Kelly
32cm 12 1/2"
Uterine Polypus
Forceps



ZI-32-744-27
Noto
27cm 10 3/4"
Uterine Polypus
Forceps



ZI-32-745-25
Heywood-Smith
25cm 9 3/4"
Uterine Polypus
Forceps



ZI-32-757-17
Doyen
17cm 6 3/4"
Myoma Screw
spiral 14 mm Ø



ZI-32-759-17
Doyen
14.5cm 5 3/4"
Myoma Screw
spiral 25 mm Ø



ZI-32-762-27
Segond
28cm 11"
Myoma Knife
cutting edge
13 mm wide



ZI-32-773-27
Dartigues
28cm 11"
Uterine Seizing
Forceps
jaw 32 mm wide



ZI-32-779-23
Sommer
22.5cm 8 3/4"
Uterine Seizing
Forceps
jaw 32 mm wide

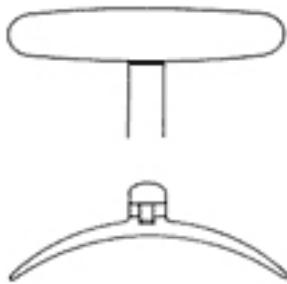

ZI-32-793-25
Collin
26cm 10 1/4"
Uterine Seizing Forceps
jaw 40 mm wide

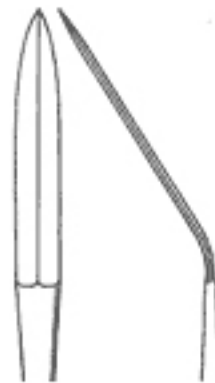

ZI-32-801-23
Ayre
23.5cm 9 1/4"
Conization Knife
cutting edge 6,3mm
wide Conization Knife



ZI-32-804-03
Emmett
22cm 8 3/4"
Fistula Hook
Fig. 3



ZI-32-806-22
Simon
21.5cm 8 1/2"
Fistula Hook



ZI-32-808-22
Simon
21.5cm 8 1/2"
Fistula Hook



ZI-32-825-23
Novak
24.5cm 9 3/4"
Suction Curette
4,0 mm Ø
with Luer-Lock
connection



ZI-32-827-30
Kevorkian
30cm 11 3/4"
Uterine Biopsy Curette
6,0 mm Ø



ZI-32-829-27
München
27cm 10 3/4"
Uterine Biopsy Curette
4,8 mm Ø

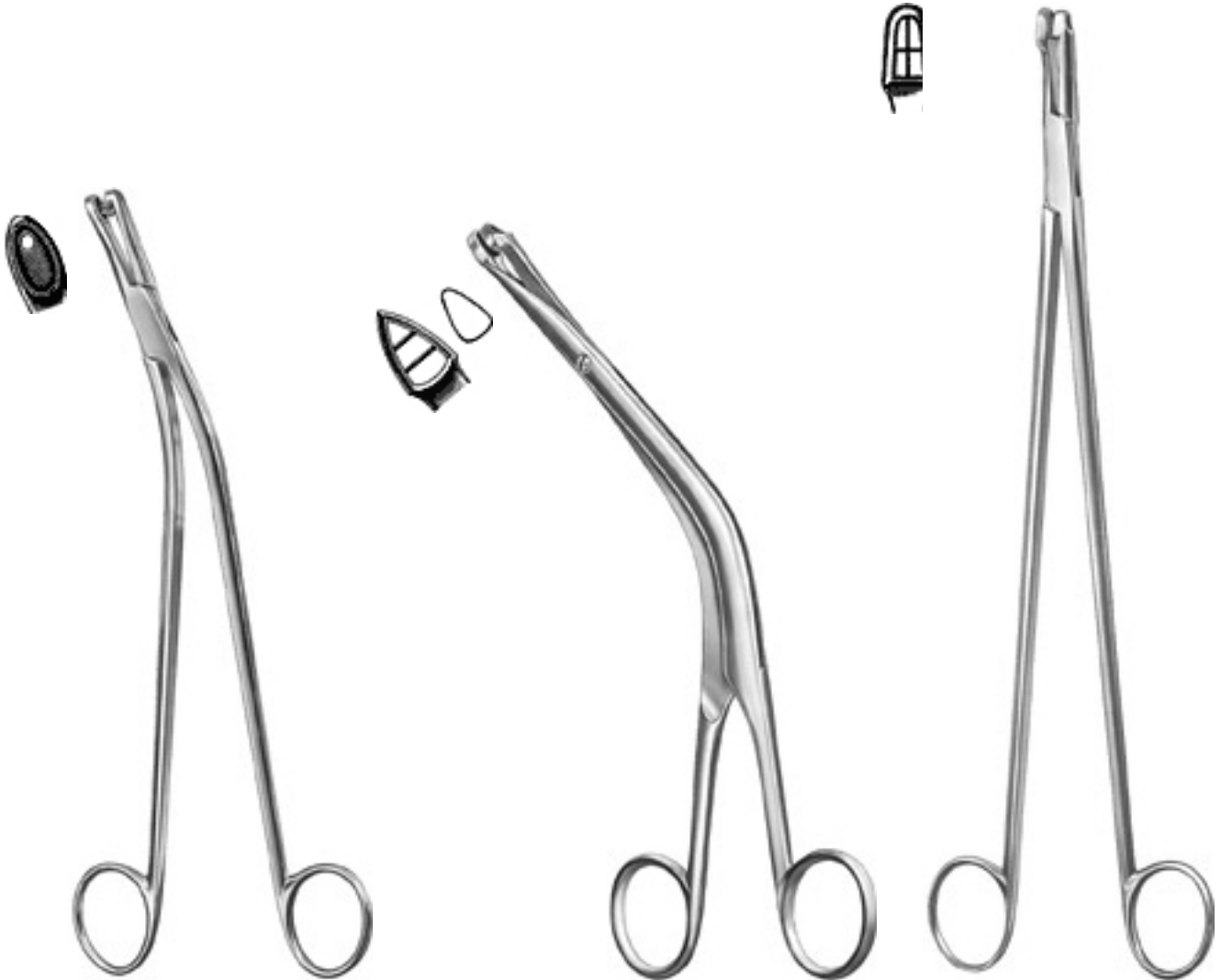

ZI-32-841-23
Gellhorn
24cm 9 1/2"
Uterine Biopsy Forceps
jaw 8,6 mm wide

ZI-32-843-21
Faure
21cm 8 1/4"
Uterine Biopsy Forceps
jaw 8,4 mm wide

ZI-32-846-21
Schubert
21.5cm 8 1/2"
Uterine Biopsy Forceps
jaw 4,8 mm wide



ZI-32-846-28
Schubert
28cm 11"
Uterine Biopsy Forceps
jaw 4,8 mm wide



ZI-32-851-22
Thoms-Gaylor
21cm 8 1/4"
Uterine Biopsy Forceps
jaw 5,6 mm Ø



ZI-32-851-24
Thoms-Gaylor
23.5cm 9 1/4"
Uterine Biopsy Forceps
jaw 5,6 mm Ø

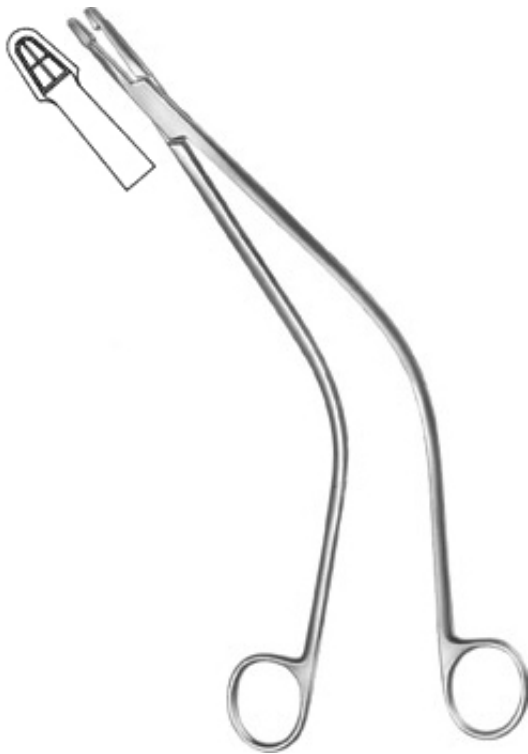

ZI-32-853-26
Schubert
25.5cm 10"
Uterine Biopsy Forceps
jaw 5,0 mm wide



ZI-32-855-24
Van Doren
27cm 10 3/4"
Uterine Biopsy Forceps
jaw 5,5 mm wide



ZI-32-855-25
Van Doren
25.5cm 10"
Uterine Biopsy Forceps
jaw 4,9 mm wide



ZI-32-857-28

Alexander

28cm 11"

Uterine Biopsy Forceps

jaw 5,1 mm wide

retrograde cutting, jaws curved to left suitable also in colpos copy

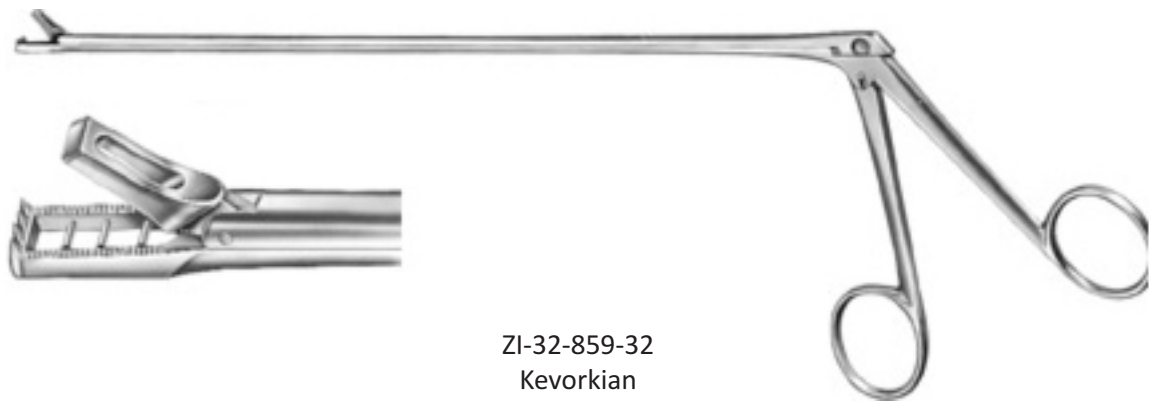

ZI-32-859-32

Kevorkian

25cm 9 3/4"

Uterine Biopsy Forceps

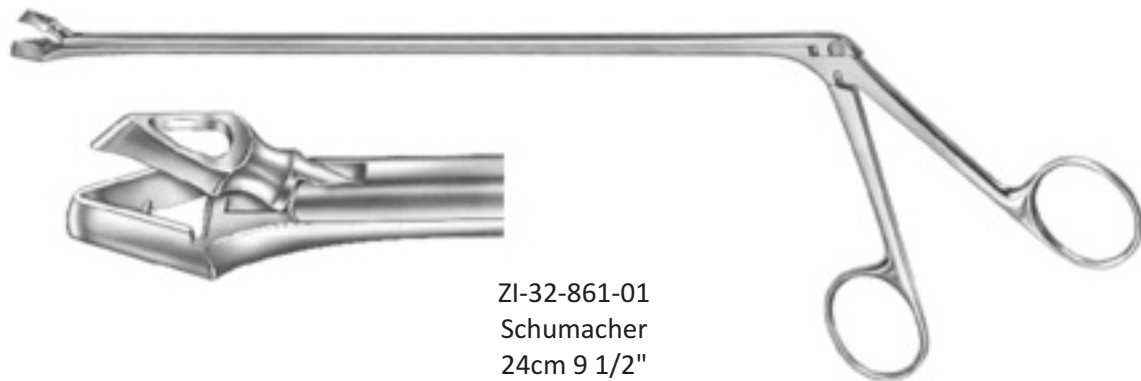

ZI-32-861-01

Schumacher

24cm 9 1/2"

Uterine Biopsy Forceps

jaw 4,6 mm wide

ZI-32-861-02

Schumacher

24cm 9 1/2"

Uterine Biopsy Forceps

jaw 5,4 mm wide



A

ZI-32-865-00
Schumacher
25cm 9 3/4"
Uterine Biopsy Forceps
complete

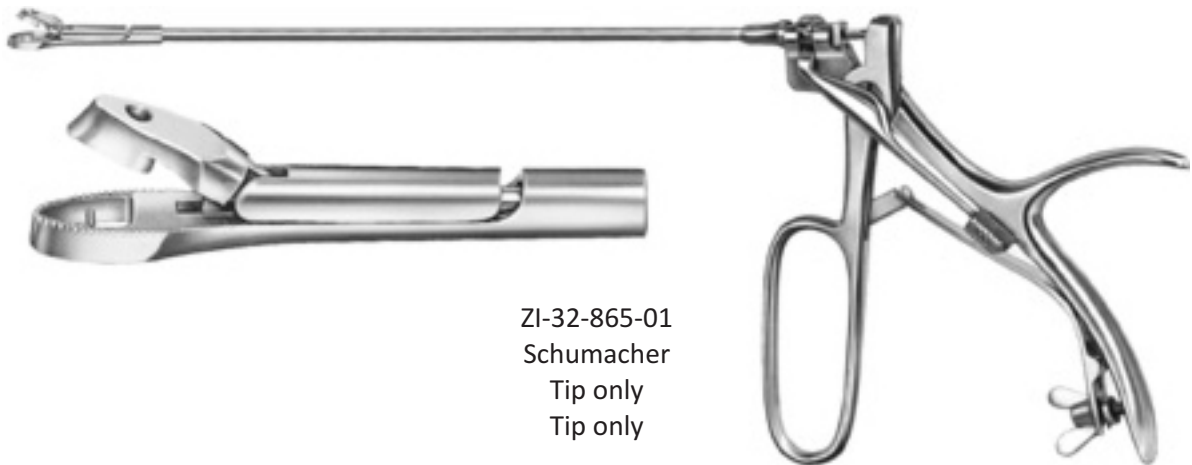

ZI-32-865-01
Schumacher
Tip only
Tip only



ZI-32-866-22
22cm 8 3/4"
IUP Grasping Forceps
3,0 mm Ø
flexible shaft
for grasping intra
uterine devices

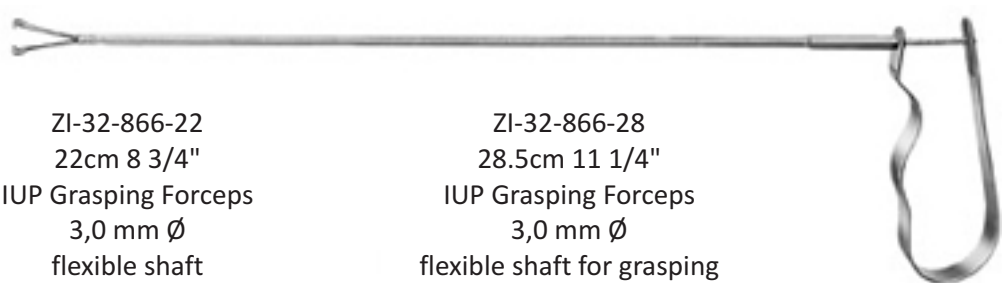

ZI-32-866-28
28.5cm 11 1/4"
IUP Grasping Forceps
3,0 mm Ø
flexible shaft for grasping
intra uterine devices



ZI-32-900-01
Simon
24.5cm 9 3/4"
Uterine Scoop
9,8 x 6,8 mm
sharp, rigid



ZI-32-900-02
Simon
24.5cm 9 3/4"
Uterine Scoop
11,6 x 8,3 mm
sharp, rigid



ZI-32-900-03
Simon
24.5cm 9 3/4"
Uterine Scoop
13,2 x 10,0 mm
sharp, rigid



ZI-32-900-04
Simon
24.5cm 9 3/4"
Uterine Scoop
16,0 x 11,6 mm
sharp, rigid



ZI-32-900-05
Simon
25cm 9 3/4"
Uterine Scoop
18,0 x 12,6 mm
sharp, rigid



ZI-32-900-06
Simon
25cm 9 3/4"
Uterine Scoop
20,0 x 13,8 mm
sharp, rigid



ZI-32-906-01
Simon
30cm 11 3/4"
Uterine Scoop
9,8 x 6,8 mm
sharp, rigid



ZI-32-906-02
Simon
30cm 11 3/4"
Uterine Scoop
11,6 x 8,3 mm
sharp, rigid



ZI-32-906-03
Simon
31cm 12 1/4"
Uterine Scoop
13,2 x 10,0 mm
sharp, rigid



ZI-32-906-04
Simon
31cm 12 1/4"
Uterine Scoop
16,0 x 11,6 mm
sharp, rigid





















ZI-32-906-05
Simon
31cm 12 1/4"
Uterine Scoop
18,0 x 12,6 mm
sharp, rigid



ZI-32-906-06
Simon
31cm 12 1/4"
Uterine Scoop
20,0 x 13,8 mm
sharp, rigid



| | | | | | |
|---|---|---|---|---|---|
|  |  |  |  |  |  |
| ZI-32-920-05 Recamier 31cm 12 1/4" Uterine Curette Fig. 00 5 mm sharp, rigid | ZI-32-920-06 Recamier 31cm 12 1/4" Uterine Curette Fig. 0 6 mm sharp, rigid | ZI-32-920-07 Recamier 31cm 12 1/4" Uterine Curette Fig. 1 7 mm sharp, rigid | ZI-32-920-08 Recamier 31cm 12 1/4" Uterine Curette Fig. 2 8 mm sharp, rigid | ZI-32-920-09 Recamier 31cm 12 1/4" Uterine Curette Fig. 3 9 mm sharp, rigid | ZI-32-920-11 Recamier 31cm 12 1/4" Uterine Curette Fig. 4 11 mm sharp, rigid |
|  |  |  |  |  |  |
| ZI-32-920-12 Recamier 31cm 12 1/4" Uterine Curette Fig. 5 12 mm sharp, rigid | ZI-32-920-14 Recamier 31cm 12 1/4" Uterine Curette Fig. 6 14 mm sharp, rigid | ZI-32-920-15 Recamier 31cm 12 1/4" Uterine Curette Fig. 7 15 mm sharp, rigid | ZI-32-920-16 Recamier 31cm 12 1/4" Uterine Curette Fig. 8 16 mm sharp, rigid | ZI-32-920-19 Recamier 31cm 12 1/4" Uterine Curette Fig. 9 19 mm sharp, rigid | ZI-32-920-20 Recamier 31cm 12 1/4" Uterine Curette Fig. 10 20 mm sharp, rigid |
|  |  |  |  |  |  |
| ZI-32-920-21 Recamier 31cm 12 1/4" Uterine Curette Fig. 11 21 mm sharp, rigid | ZI-32-920-23 Recamier 31cm 12 1/4" Uterine Curette Fig. 12 23 mm sharp, rigid | ZI-32-920-25 Recamier 34cm 13 1/2" Uterine Curette Fig. 13 25 mm sharp, rigid | ZI-32-920-30 Recamier 35cm 13 3/4" Uterine Curette Fig. 14 30 mm sharp, rigid | ZI-32-920-35 Recamier 35cm 13 3/4" Uterine Curette Fig. 15 35 mm sharp, rigid | ZI-32-920-40 Recamier 35cm 13 3/4" Uterine Curette Fig. 16 40 mm sharp, rigid |















ZARYAB INSTRUMENTS







Products that saves life

Gynecology



| | | | | | |
|--|---|---|---|---|---|
|  |  |  |  |  |  |
| ZI-32-921-05 | ZI-32-921-06 | ZI-32-921-07 | ZI-32-921-08 | ZI-32-921-09 | ZI-32-921-11 |
| Recamier | Recamier | Recamier | Recamier | Recamier | Recamier |
| 31cm 12 1/4" | 31cm 12 1/4" | 31cm 12 1/4" | 31cm 12 1/4" | 31cm 12 1/4" | 31cm 12 1/4" |
| Uterine Curette | Uterine Curette | Uterine Curette | Uterine Curette | Uterine Curette | Uterine Curette |
| Fig. 00 | Fig. 0 | Fig. 1 | Fig. 2 | Fig. 3 | Fig. 4 |
| 5 mm | 6 mm | 7 mm | 8 mm | 9 mm | 11 mm |
| sharp, malleable sharp, malleable sharp, malleable sharp, malleable sharp, malleable | | | | | |



















| | | | | | |
|--|---|---|---|---|---|
|  |  |  |  |  |  |
| ZI-32-921-12 | ZI-32-921-14 | ZI-32-921-15 | ZI-32-921-16 | ZI-32-921-19 | ZI-32-921-20 |
| Recamier | Recamier | Recamier | Recamier | Recamier | Recamier |
| 31cm 12 1/4" | 31cm 12 1/4" | 31cm 12 1/4" | 31cm 12 1/4" | 31cm 12 1/4" | 31cm 12 1/4" |
| Uterine Curette | Uterine Curette | Uterine Curette | Uterine Curette | Uterine Curette | Uterine Curette |
| Fig. 5 | Fig. 6 | Fig. 7 | Fig. 8 | Fig. 9 | Fig. 10 |
| 12 mm | 14 mm | 15 mm | 16 mm | 19 mm | 20 mm |
| sharp, malleable sharp, malleable sharp, malleable sharp, malleable sharp, malleable | | | | | |

| | | | | | |
|--|---|---|---|---|---|
|  |  |  |  |  |  |
| ZI-32-921-21 | ZI-32-921-23 | ZI-32-921-25 | ZI-32-921-30 | ZI-32-921-35 | ZI-32-921-40 |
| Recamier | Recamier | Recamier | Recamier | Recamier | Recamier |
| 31cm 12 1/4" | 31cm 12 1/4" | 34cm 13 1/2" | 35cm 13 3/4" | 35cm 13 3/4" | 35cm 13 3/4" |
| Uterine Curette | Uterine Curette | Uterine Curette | Uterine Curette | Uterine Curette | Uterine Curette |
| Fig. 11 | Fig. 12 | Fig. 13 | Fig. 14 | Fig. 15 | Fig. 16 |
| 21 mm | 23 mm | 25 mm | 30 mm | 35 mm | 40 mm |
| sharp, malleable sharp, malleable sharp, malleable sharp, malleable sharp, malleable | | | | | |



Gynecology



| | | | | | |
|---|---|---|--|---|---|
|  |  |  |  |  |  |
| ZI-32-926-05 Sims 31cm 12 1/4" Uterine Curette Fig. 00 5 mm blunt, rigid | ZI-32-926-06 Sims 31cm 12 1/4" Uterine Curette Fig. 0 6 mm blunt | ZI-32-926-07 Sims 31cm 12 1/4" Uterine Curette Fig. 1 7 mm blunt | ZI-32-926-08 Sims 31cm 12 1/4" Uterine Curette Fig. 2 8 mm blunt | ZI-32-926-09 Sims 31cm 12 1/4" Uterine Curette Fig. 3 9 mm blunt | ZI-32-926-11 Sims 31cm 12 1/4" Uterine Curette Fig. 4 11 mm blunt |
|  |  |  |  |  |  |
| ZI-32-926-12 Sims 31cm 12 1/4" Uterine Curette Fig. 5 12 mm blunt | ZI-32-926-14 Sims 31cm 12 1/4" Uterine Curette Fig. 6 14 mm blunt | ZI-32-926-15 Sims 31cm 12 1/4" Uterine Curette Fig. 7 15 mm blunt | ZI-32-926-16 Sims 31cm 12 1/4" Uterine Curette Fig. 8 16 mm blunt | ZI-32-926-19 Sims 31cm 12 1/4" Uterine Curette Fig. 9 19 mm blunt | ZI-32-926-20 Sims 31cm 12 1/4" Uterine Curette Fig. 10 20 mm blunt |
|  |  |  |  |  |  |
| ZI-32-926-21 Sims 31cm 12 1/4" Uterine Curette Fig. 11 21 mm blunt | ZI-32-926-23 Sims 31cm 12 1/4" Uterine Curette Fig. 12 23 mm blunt | ZI-32-926-25 Sims 34cm 13 1/2" Uterine Curette Fig. 13 25 mm blunt | ZI-32-926-30 Sims 35cm 13 3/4" Uterine Curette Fig. 14 30 mm blunt | ZI-32-926-35 Sims 35cm 13 3/4" Uterine Curette Fig. 15 35 mm blunt | ZI-32-926-40 Sims 35cm 13 3/4" Uterine Curette Fig. 16 40 mm blunt |



Gynecology



ZI-32-927-05
Sims
31cm 12 1/4"
Uterine Curette
Fig. 00
5 mm blunt,
malleable



ZI-32-927-06
Sims
31cm 12 1/4"
Uterine Curette
Fig. 0
6 mm blunt,
malleable



ZI-32-927-07
Sims
31cm 12 1/4"
Uterine Curette
Fig. 1
7 mm blunt,
malleable



ZI-32-927-08
Sims
31cm 12 1/4"
Uterine Curette
Fig. 2
8 mm blunt,
malleable



ZI-32-927-09
Sims
31cm 12 1/4"
Uterine Curette
Fig. 3
9 mm blunt,
malleable



ZI-32-927-11
Sims
31cm 12 1/4"
Uterine Curette
Fig. 4
11 mm blunt,
malleable



ZI-32-927-12
Sims
31cm 12 1/4"
Uterine Curette
Fig. 5
12 mm blunt,
malleable



ZI-32-927-14
Sims
31cm 12 1/4"
Uterine Curette
Fig. 6
14 mm blunt,
malleable



ZI-32-927-15
Sims
31cm 12 1/4"
Uterine Curette
Fig. 7
15 mm blunt,
malleable



ZI-32-927-16
Sims
31cm 12 1/4"
Uterine Curette
Fig. 8
16 mm blunt,
malleable



ZI-32-927-19
Sims
31cm 12 1/4"
Uterine Curette
Fig. 9
19 mm blunt,
malleable



ZI-32-927-20
Sims
31cm 12 1/4"
Uterine Curette
Fig. 10
20 mm blunt,
malleable



ZI-32-927-21
Sims
31cm 12 1/4"
Uterine Curette
Fig. 11
21 mm blunt,
malleable



ZI-32-927-23
Sims
31cm 12 1/4"
Uterine Curette
Fig. 12
23 mm blunt,
malleable



ZI-32-927-25
Sims
34cm 13 1/2"
Uterine Curette
Fig. 13
25 mm blunt,
malleable



ZI-32-927-30
Sims
35cm 13 3/4"
Uterine Curette
Fig. 14
30 mm blunt,
malleable



ZI-32-927-35
Sims
35cm 13 3/4"
Uterine Curette
Fig. 15
35 mm blunt,
malleable

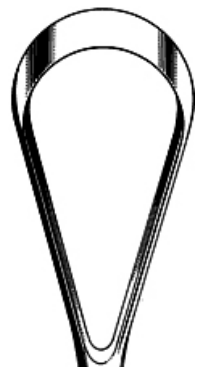

ZI-32-927-40
Sims
35cm 13 3/4"
Uterine Curette
Fig. 16
40 mm blunt,
malleable



ZARYAB
I N S T R U M E N T S

Products that saves life

Gynecology



ZI-32-989-03
29cm 11 1/2"
Suction Curette
3,0 mm Ø



ZI-32-989-04
29cm 11 1/2"
Suction Curette
4,5 mm Ø



ZI-32-989-06
29cm 11 1/2"
Suction Curette
6,0 mm Ø



ZARYAB
I N S T R U M E N T S

Products that saves life

Gynecology



ZI-32-989-08
29cm 11 1/2"
Suction Curette
8,0 mm Ø

ZI-32-989-10
29cm 11 1/2"
Suction Curette
9,0 mm Ø

ZI-32-989-12
29cm 11 1/2"
Suction Curette
12,0 mm Ø



ZARYAB
I N S T R U M E N T S

Products that saves life

Gynecology

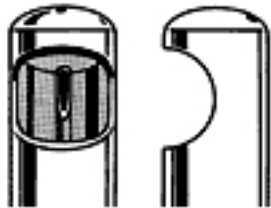

ZI-32-989-14
29cm 11 1/2"
Suction Curette
14,0 mm Ø



ZI-32-989-50
12cm 4 3/4"
Coupling Piece
Coupling Piece



ZARYAB
INSTRUMENTS

Products that saves life

Gynecology



ZI-32-995-00

Schultze

29.5cm 11 ½"

Salping ographin wooden case

ZI-32-995-01

Schultze

29.5cm 11 ½"

Salping ograph

(without manometer)



ZI-32-995-02

Schultze

Manometer for Salpingograph







Products that saves life

ZARYAB

I N S T R U M E N T S

 Harar, Wazirabad Road, Pir Sabz Rd, Pir Sabz, Sialkot-51310, Pakistan

 +92 52 3573775

 +92 52 3573776

 +92 333 8608580 , +92 333 3349600

 info@zaryabinstruments.com

 sales@zaryabinstruments.com

 www.zaryabinstruments.com